

Version: V1.0

# MN 15-12KW-AIO

## All in one Inverter/Charger System



## INSTALLATION GUIDE AND USER MANUAL



## **READ THE INSTRUCTIONS COMPLETELY BEFORE OPERATING THE EQUIPMENT**



**Check the utility voltage before turning ON the unit if connected.**



**Verify the inviter's programmed grid type before connecting to the utility.**



**The unit will be programmed in 120/240V Split-Phase at 60Hz by default.**

**Disregarding these instructions could result in permanent damages to the unit**

## **DISCLAIMER**

UNLESS SPECIFICALLY AGREED TO IN WRITING, MIDNITE:

(A) DOES NOT WARRANT THE ACCURACY, SUFFICIENCY OR SUITABILITY OF ANY TECHNICAL OR OTHER INFORMATION PROVIDED IN ITS MANUALS OR OTHER DOCUMENTATION.

(B) ASSUMES NO RESPONSIBILITY OR LIABILITY FOR ANY LOSS OR DAMAGES, WHETHER DIRECT, INDIRECT, CONSEQUENTIAL, OR INCIDENTAL, ARISING OUT OF THE USE OF SUCH INFORMATION. USE OF SUCH INFORMATION SHALL BE ENTIRELY AT THE USER'S RISK.

MIDNITE is not responsible for system failure, damage or injury resulting from improper installation of its products.

Information in this manual is subject to change without notice.

This manual is only focused on the inverter labeled as: MN 15-12KW-AIO.

### Contact

Phone: (USA) +1 (360) 403-7207

Email: [support@midnitesolar.com](mailto:support@midnitesolar.com)

Website: [www.midnitesolar.com](http://www.midnitesolar.com)

# Table of Contents

IMPORTANT SAFETY INSTRUCTIONS .....	3
1. MIDNITE: At a First Glance .....	4
1.1 General Description .....	5
1.2 Specifications .....	6
1.3 Wire Gauge Guide.....	8
2. Installation.....	9
2.1 Mounting the MN 15-12KW-AIO .....	9
2.2 Connecting PV Modules .....	11
2.3 Integrating Batteries.....	12
2.4 Integrating the Generator/Smart Loads/AC Coupling .....	14
2.5 Automatic Generator Start .....	15
2.6 Integrating Sensors and Accessories.....	15
2.7 Limit Sensors (CT/Meter).....	17
2.8 RS485.....	19
2.9 Parallel Communication.....	20
2.10 Emergency Stop and Rapid Shutdown .....	20
2.11 Powering-up and Testing the MIDNITE.....	21
2.12 Power Off Sequence.....	22
2.13 LED Indicators.....	22
2.14 LCD screen .....	23
3. App Setting Guide.....	26
3.1 Installer login .....	27
3.2 Stored energy .....	27
3.3 Communication.....	37
3.4 Grid .....	37
3.5 General.....	38
3.6 Power control .....	38
3.7 Reactive power control .....	39
3.8 Equipment maintenance.....	39
3.9 Programming Guide.....	40
4. User Interface.....	41
4.1 Home.....	42
4.2 Energy .....	43
4.3 Settings.....	43
4.4 Logs.....	44
4.5 Switch .....	44
5. Parallel Systems .....	45
5.1 Before Enabling Parallel Operations .....	45
5.2 Parallel Systems Programming Sequence.....	47
5.3 Three-Phase Systems: Programming and Troubleshooting .....	50
6. Wiring Diagrams.....	51
7. Troubleshooting Guide.....	55
7.1 MIDNITE Error codes.....	55

# IMPORTANT SAFETY INSTRUCTIONS

## SYMBOLS THAT APPEAR IN THIS DOCUMENT

 **WARNING:** This symbol indicates information that, if ignored, could cause serious injury, equipment damage, or death.

 **CAUTION:** This symbol indicates information that, if ignored, could result in minor injury or equipment damage.

 **NOTE:** This symbol indicates relevant information that is not related to hazardous situations.

## WARNINGS

 Read this entire document before installing or using the MIDNITE MN 15-12KW-AIO inverter. Failure to follow any of the instructions or warnings in this document can result in electrical shock, serious injury, or death. Damage to the inverter is also possible, potentially rendering it inoperable.

 High Risk due to fire or electrocution – **ONLY** qualified persons should install the MIDNITE inverter.

 The system must have Ground connections and Neutral connections.

 **Solar PV+/PV- are UNGROUNDED.** Note, you may ground PV Racking/Mounts, but doing so directly to the MIDNITE will likely result in damage in the case of a direct lightning strike to the PV array. Ground the PV racking directly to earth ground.

 DO NOT connect the grid to the “AC OUT” output terminal.

 DO NOT reverse the polarity of batteries. **Damage WILL occur.**

 DO NOT exceed **600VDC** on any MPPT on the MIDNITE.

 DO NOT turn off the battery breaker if there is current flowing in or out of the battery in any amount.

 DO NOT use impact drivers to tighten any fasteners on the MIDNITE.

 Use conduit for AC and DC wires entering/exiting the wiring compartment to meet NEC and CSA code.

 ALL terminals/breakers, including battery, MPPT, and AC Terminal Blocks should have only one conductor connected to each terminal. Pig tailing is an acceptable method to legally connect two wires to one circuit.

# 1. MIDNITE: At a First Glance

## INSPECT SHIPMENT

The box should include all items shown in the component guide. If there is damage or missing parts, immediately call the phone number (USA) (360)-403-7207.

## COMPONENT GUIDE

The MIDNITE MN 15-12KW-AIO system includes the following components:

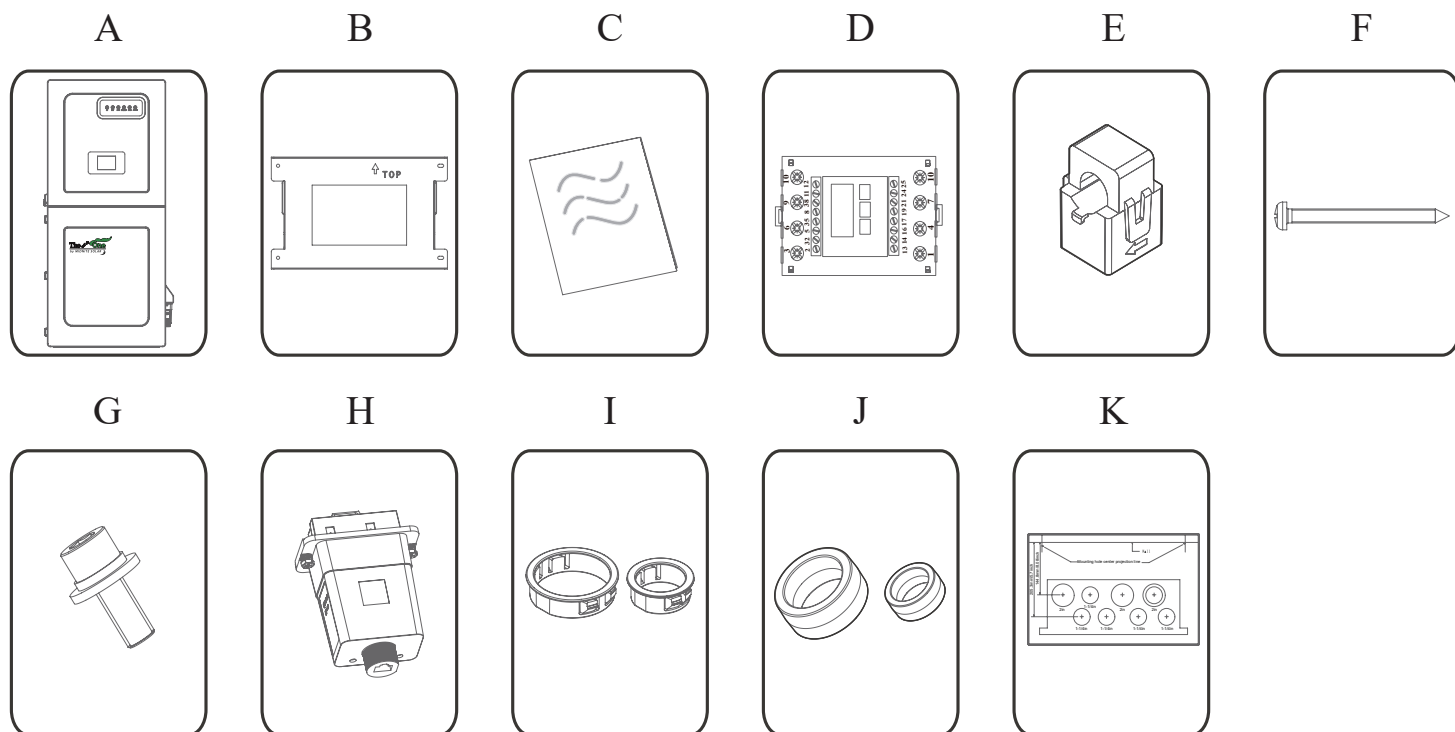

Component	Description	Quantity
A	Inverter	1
B	Mounting Bracket	1
C	File Package	1
D	Meter (Optional)	1
E	CT	2
F	M6 Self-tapping Screw	4
G	M6 Security Screw	1
H	WiFi/Ethernet Dangle	1
I	Bushing Ring ( $\phi 67.5\text{mm}$ & $\phi 49\text{mm}$ )	$\phi 67.5\text{mm}$ : 3 $\phi 49\text{mm}$ : 6
J	Toroid ( $\phi 53\text{mm}$ (Battery) & $\phi 30\text{mm}$ (Ground of Grid))	2
K	Gutter Template	1

# 1.1 General Description

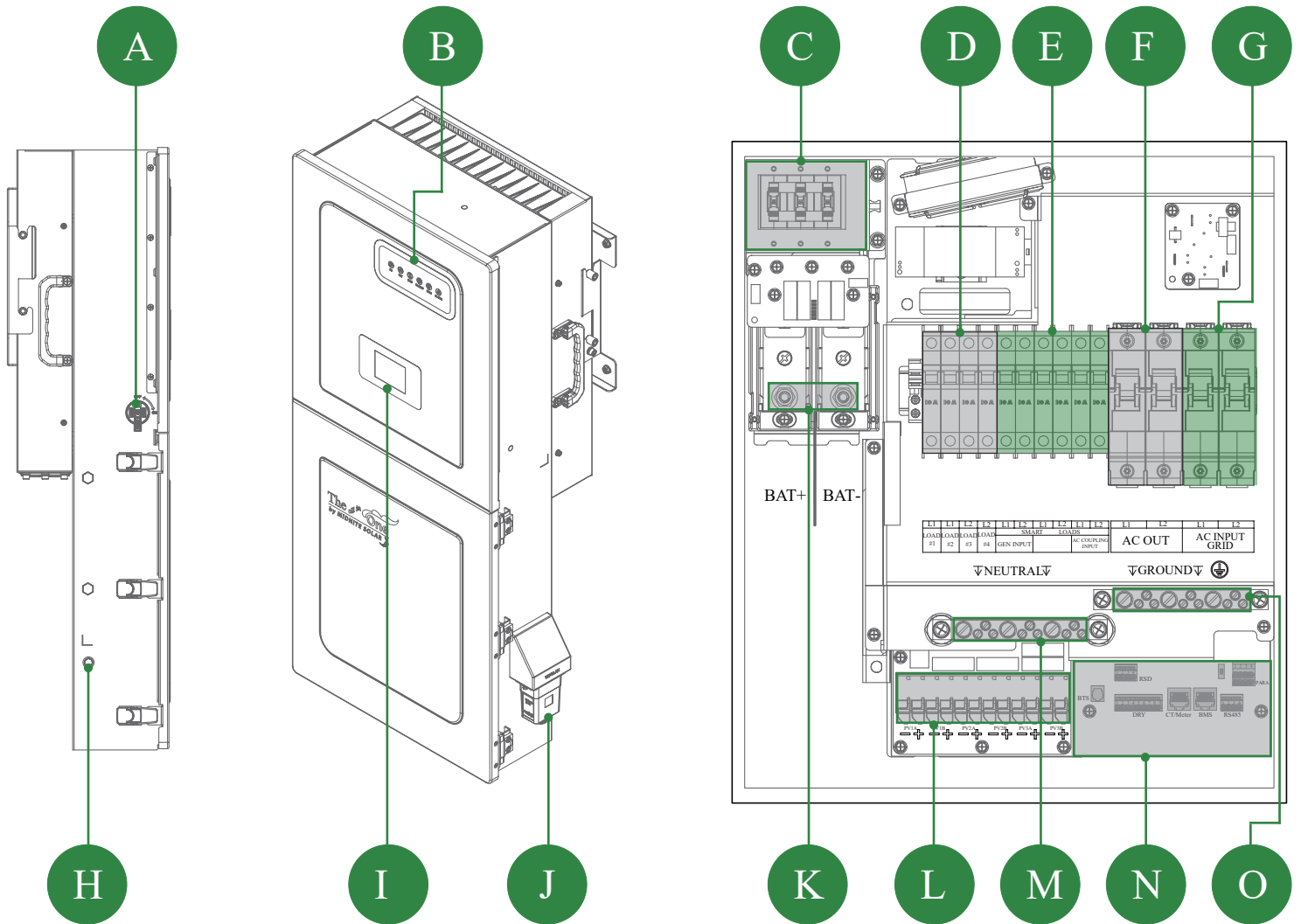

Component	Description
A	PV switch
B	LED screen
C	300 amp Hydraulic/magnetic Bat breaker
D	Three 15A & one 20A 120VAC Load brkrs
E	120/240VAC Smart load brkrs 60+30+50A <b>OR</b> 60A Gen input+ 30A Smart Load+50A AC coupling --Use each dual breaker as a load or input and program accordingly
F	100A 120/240VAC AC OUT
G	100A 120/240VAC AC IN
H	ON/OFF Button
I	LCD screen

Component	Description
J	Wi-Fi / Ethernet dongle
K	5/16-18UNC Battery connection terminals
L	PV connection terminal block
M	NEUTRAL Busbar
N	Communication connection ports (RS485, BMS, DRM, CT, DRY, RSD, PARA)
O	GROUND Busbar

## 1.2 Specifications

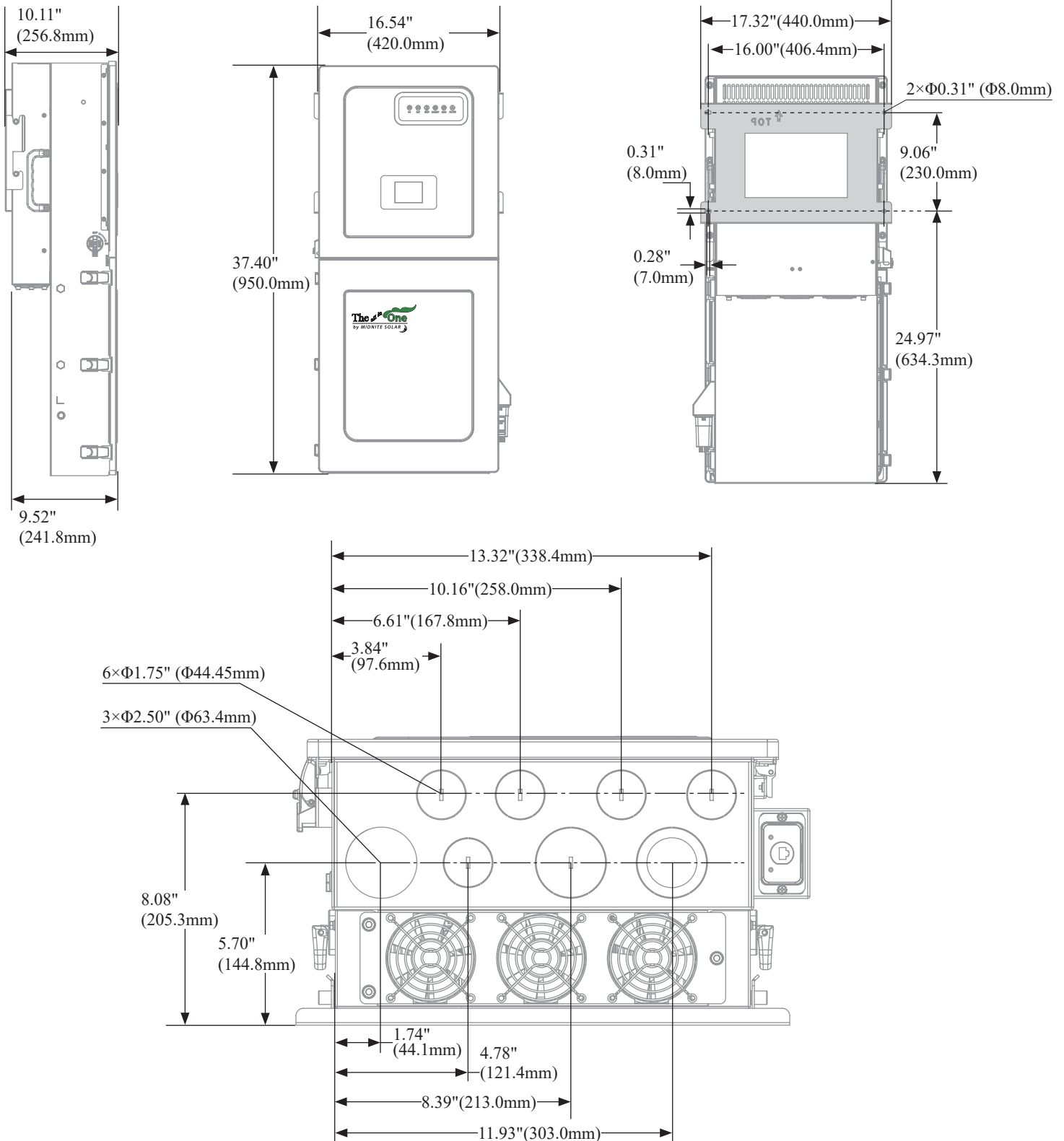

Terminal	Torque [in-lb]	Torque [Nm]
LOAD(#1/#2/#3/#4)	20 in-lb	2.5 Nm
Smart loads breaker/Gen input/AC coupling	20 in-lb	2.5 Nm
AC out	35 in-lb	4 Nm
Neutral / Ground (Busbar)	50 in-lb (7/16-20 UNF) / 26 in-lb (1/4-28 UNF)	5.6 Nm (7/16-20 UNF) / 2.9 Nm (1/4-28 UNF)
AC Input Grid	35 in-lb	4 Nm
Battery Connection	126 in-lb	15 Nm



## Datasheet

## UL: MN 15-12KW-AIO

<b>Input Data (PV)</b>	
Max. Allowed PV Power (STC)	15,000W
Nominal Voltage Range (Vdc)	70-550VDC
Startup Voltage	90V
Max. Input Voltage	600V
Max. Input Current per MPPT	PV A: 30A; PV B/C: 22A
No. of MPP Trackers	3
No. of PV Strings per MPPT	2
Max. AC Coupled Input	10,000W
<b>Output Data (AC)</b>	
Nominal AC Voltage	120/240V, 120/208V
Grid Frequency	50 / 60Hz
Real Power, max continuous	11,400W
Max. Output Current	47.5A
Real Power, max continuous (batteries only, no PV)	10,000W (41.7A @240V)
Peak Apparent Power (60s, off -Grid)	14,000VA @ 240V
Peak Apparent Power (1s, off-grid)	> 15,000VA @ 240V
Max. Grid Passthrough Current	100A
Power Factor Output Range	+/- 0.8 adjustable
Backup Transfer Time	Typical: 10ms, Max: 20ms
Design (DC to AC)	Transformer DC
Stackable	Up to 9 in parallel
<b>Battery Input Data (DC)</b>	
Battery Technologies	Lithium / Lead Acid
Nominal DC Voltage	48V
Operating Voltage Range	40-64V
Max. Battery Charge / Discharge Current	210A
Charging Controller	3-Stage with Equalization
Grid to Battery Charging Efficiency	Max: 93.4%
External Battery Temperature Sensor	Not Included
Current Shunt for Accurate % SOC	Integrated
Automatic Generator Start	Integrated
Communication to Lithium	CANBus & RS485
<b>General Data</b>	
Dimensions (H x W x D)	950 x 420 x 241.8 mm / 37.40 x 16.54 x 9.52 in
Net Weight / Package Weight	46.2 Kg(101.85 lb.) / 53.9 Kg(118.83 lb.)
Enclosure	IP65 / NEMA 3R
Ambient Temperature	-25-60°C, > 45°C Derating
Noise(No Load)	< 40 dB
Idle consumption - No Load	85W
Wi-Fi & LAN Communication	Included
Standard Warranty	10 Years
<b>Protection and Certifications</b>	
Electronics Certified Safety by SGS Labs to NEC & UL Specs	Yes
Grid Sell Back — UL1741 3rd 2021, IEEE1547a 2018/2020, FCC 15 Class B, UL1741SB, CA Rule	Yes
Hawaiian Electric Companies, IEEE 1547.1-2020 Source Requirements Document Version 2.0 (“SRD V2.0”), effective on July 1st, 2020	Yes
PV DC Disconnect Switch — UL 508	Integrated
Ground Fault Detection — UL 1741 CRD	Integrated
PV Rapid Shutdown Control — UL1741 SECTION 92 TO SECTION 99	Integrated
PV Arc Fault Detection — UL 1699B	Integrated
PV Input Lightning Protection	Integrated
PV String Input Reverse Polarity Protection	Integrated
300A x 1 Battery Breaker / Disconnect	Integrated
Surge Protection	DC Type II / AC Type II
2024 MIDNITE SOLAR INC. Support: 360-403-7207, support@midnitesolar.com Sales: 360-403-7207 sales@midnitesolar.com	



# 1.3 Wire Gauge Guide

## 1. AC Input/Outputs:

- “AC INPUT GRID” Terminal 100A MAX passthrough, 2 AWG conductor.
- “AC OUTPUT” Terminal 100A MAX passthrough, 2 AWG conductor.
- Backed up Sub-panel may have more than 100 amps of load circuits although the utility pass through current is limited to 100 amps continuous per leg. Inverter output current when inverting is limited to 47.5 amps continuous per leg

 Wire gauge should be selected in compliance with your local electrical code

## 2. SENSORS CT: 16.40 ft [5 m] included.

## 3. BATTERY CABLES: 4/0 AWG THHN / Max Charge and Discharge limited to 260A

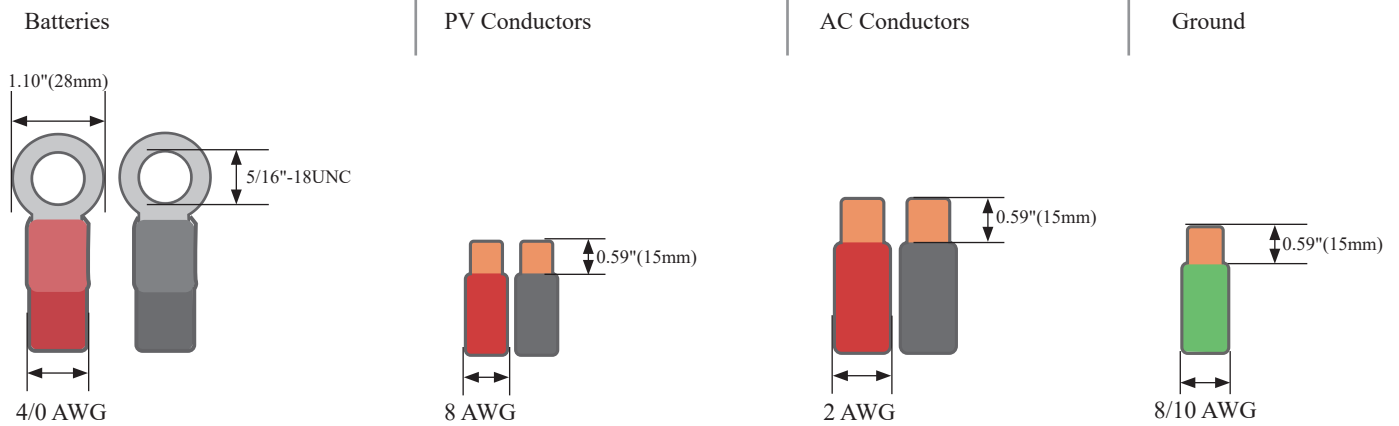

### CT Sensors (Included)

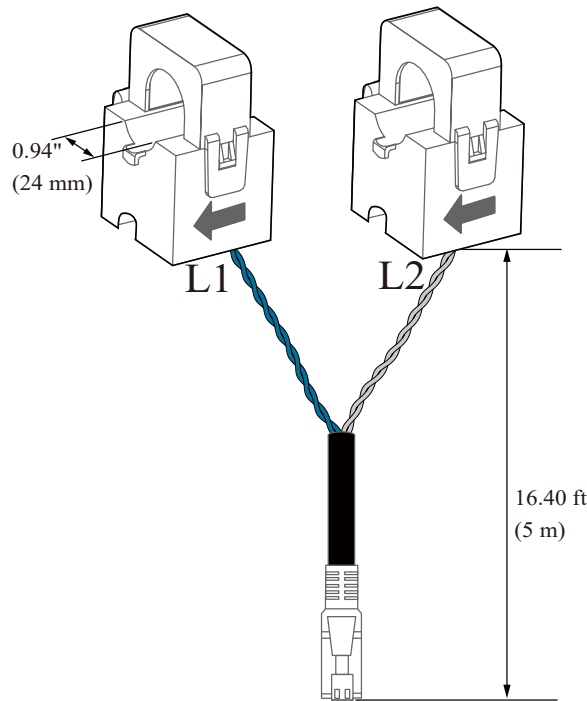

## Ground Toroid (φ30mm)

The ground cable of the Grid needs to be wrapped around the toroid twice, as shown below.

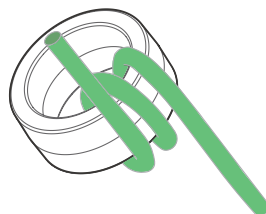

## 2. Installation

### AC Out Backed up Circuits

- A. The sub panel powered by the "AC OUT" circuit breaker terminals will be considered the Critical or Essential Loads Panel.
- B. You may want to keep the essential loads panel within the limitations of the unit, however this panel is protected by 100A breakers.
- Grid Tie → 24 kW = 100A continuous @ 240V (passthrough). 100 amps per 120VAC leg
  - Off-Grid → 11.4kW = 47.5A @ 240V (PV & battery) | 10kW = 41.6A @ 240V (batteries only)
- C. You can design for only continuous loads on the essential loads panel, however it is common to add more since loads are not normally continuous and fully consuming each breaker rating. You may add more loads than what can be powered, but the maximum continuous is stated above

### Single System Install

#### A. INVERTER AC IN and OUT:

- A 2 pole 125A disconnect/breaker must be installed in the main utility distribution panel (2AWG) to feed the MN 15-12KW-AIO to protect the conductors.

 Normal stab in breakers are normally thermal and can only be used at 80% of their rating. MidNite Solar uses hydraulic/magnetic breakers that can be continuously used at 100% of their rating. Size cables for 125A.

- Connect the inverter 100A "AC OUT" breaker to the Essential Loads Panel using 2 AWG conductors

#### B. SMART LOADS:

- There are three 120/240VAC smart load breakers. Each smart load breaker has a programmable relay in series with the breaker.
- 60A as an input is for generator hookup. 60A as an output would be for a heavy load like EV charging.
- 50A as an input can be for AC coupling. 50A as an output can be for an electric range/oven.
- 30A does not allow an input. 30A as an output can be for an electric dryer or hot water heater or air conditioner or other uses.

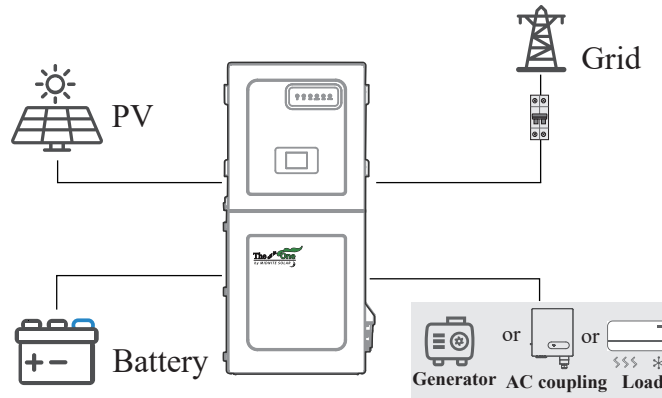

### 2.1 Mounting the MN 15-12KW-AIO

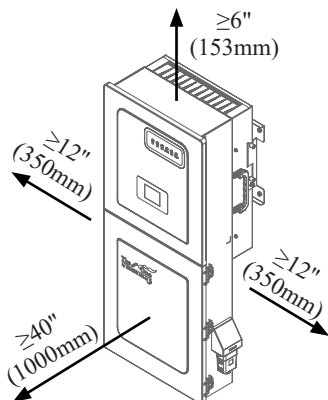

A. The system weight is 101.85 lb.(46.2 Kg).

B. Considering the dimensions of the inverter, find a suitable location for the system(s). There must be at least 6 in [15 cm] of vertical clearance for proper heat dissipation.

 Heat transfer and cooling is done from bottom to top at a rate of 525W/hr

C. The MIDNITE MN 15-12KW-AIO is a NEMA 3R - IP65 enclosure that is rated for outdoor installation but can also be installed indoors.

D. ⚠️ PROTECT THE LCD SCREEN from direct exposure to UV light.

E. Mount the MIDNITE and ensure the unit is level and properly seated.

F. Securely attach the inverter to the mounting surface. You may need expansion plugs or anchors for concrete. In case a different anchorage is required, calculate the support needed to properly hold the weight of the equipment.

G. Remove the sticker on the bottom of the equipment before mounting. Use gutter template to mark the installation location on the wire guard.

4×Φ0.18"(4.5mm) ↓2.30"(60mm)

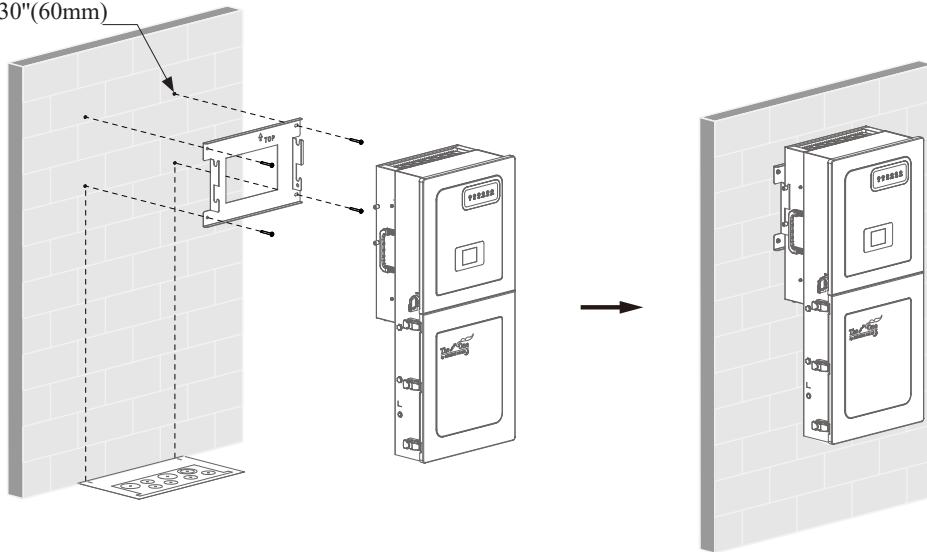

 Damage to the LCD Screen due to direct sunlight exposure will not be covered by warranty

H. Use the bushing rings as needed.

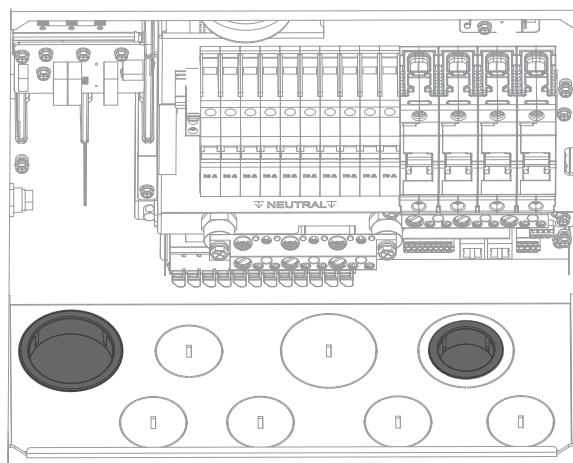

I. Mount the inverter in the optimal orientation as shown below.

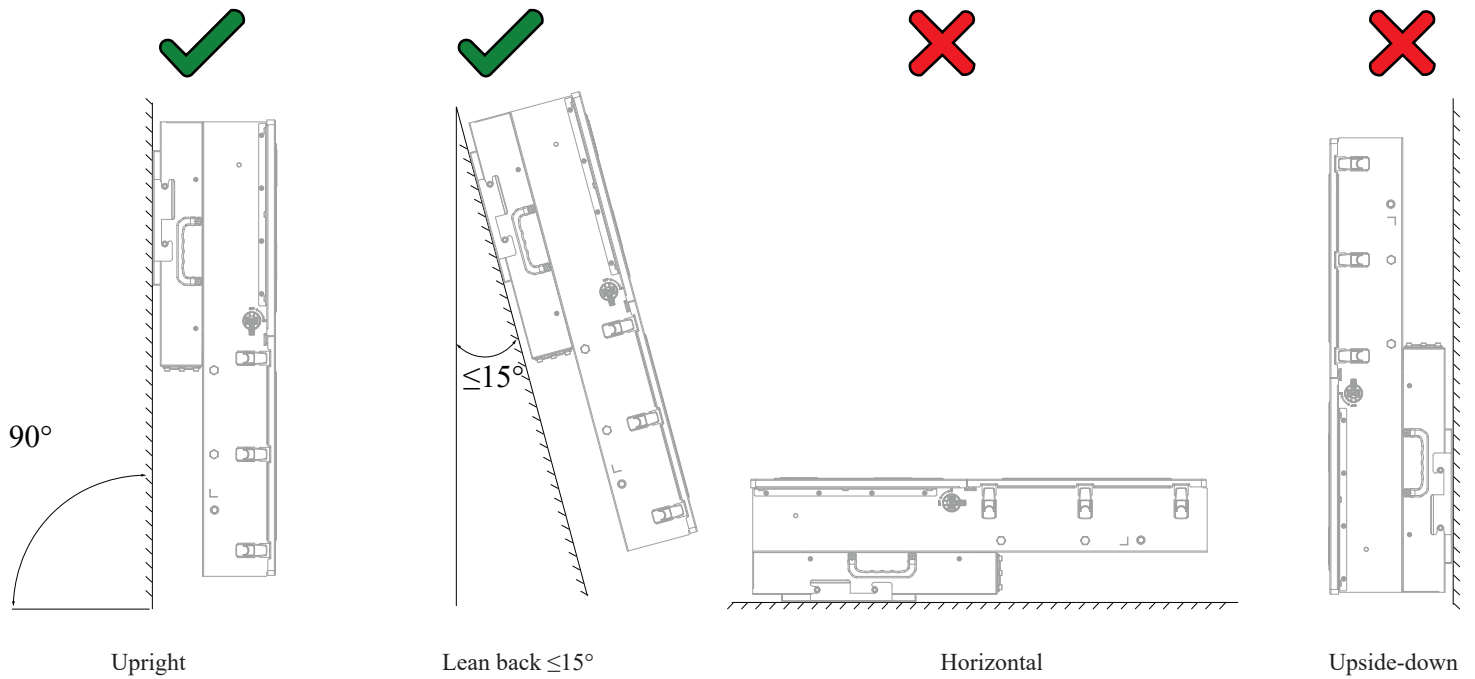

## 2.2 Connecting PV Modules

 The inverter has 3 independent MPPTs and each can handle up to 2 PV strings. Each MPPT can operate at a current of 30A/22A/22A (self-limiting) and a MAX Voc of 600V.

A. Max DC solar input = 15 kW ( $\pm 5\%$ ) | Max input power MPPT = 10 kW | Max input voltage per MPPT = 600 VOC | Max input current per MPPT = 30A/22A/22A (self-limiting).

B.  **There will be damage if Voc > 600V**

C.  Strings in parallel on the same MPPT must have the same designed open-circuit voltage (Voc), otherwise the system will be limited to the lowest string voltage. Shading on one of the two strings will result in averaging the maximum power voltage.

i. PV1 A/B must have the same Voc.

ii. If the solar panels are oriented in different directions and connected in the same MPPT, there will be a loss in PV efficiency.

D.  It is required per code in the US and Canada to ground the mounting frame from the PV array to an **external grounding system**.

E.  Design for a max input current of 30A MPPT1. The inverter will self-limit beyond 30A. If current exceeds 40A Isc limit, damage will occur.

F. Connect the solar panel strings using either of the following configurations:

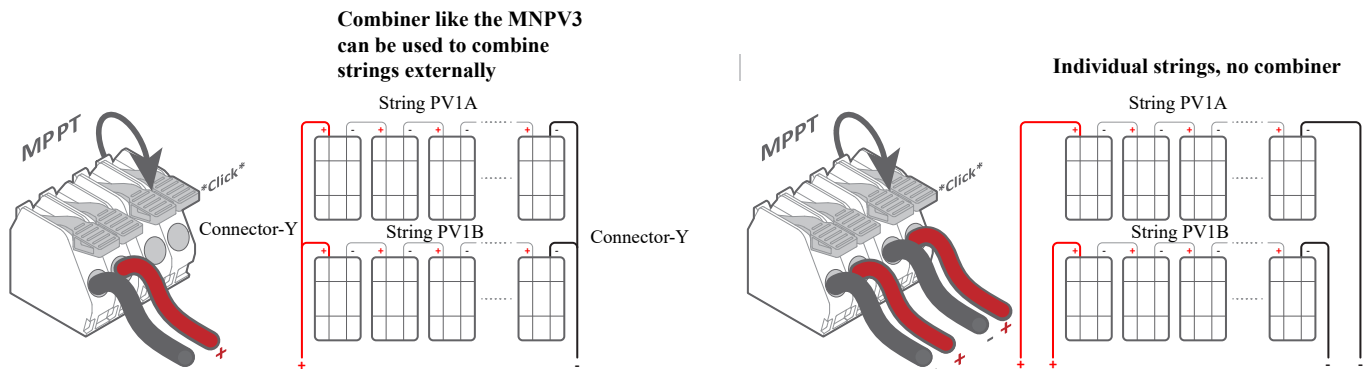

## 2.3 Integrating Batteries

- A. ⚠️ MIDNITE MN 15-12KW-AIO must be OFF while the batteries are being connected.
- B. Depending on the battery voltage, wire up the battery bank in the possible configurations shown in figures.
- C. Battery breakers must be OFF when wiring. If your battery bank does not have internal breakers, maintain the necessary safety measures when handling.
- D. 📄 The inverter/charger reaches a max battery charge/discharge of 210A.

⚠️ MIDNITE MN 15-12KW-AIO is a **48V nominal system**. **DO NOT** connect the inverter to any other battery configuration. If you use 12V batteries, you **MUST NOT** exceed four (4) batteries in series, as shown in Figure 5b. The inverter can work with any battery chemistry as long as it remains within the range of **40Vdc to 64Vdc**.

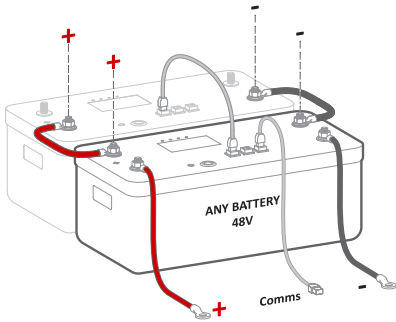

Figure 5a: 48Vdc batteries in parallel connection

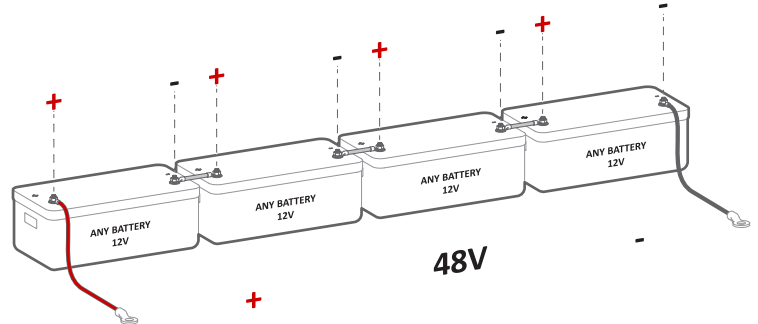

Figure 5b: 12Vdc batteries in series connection

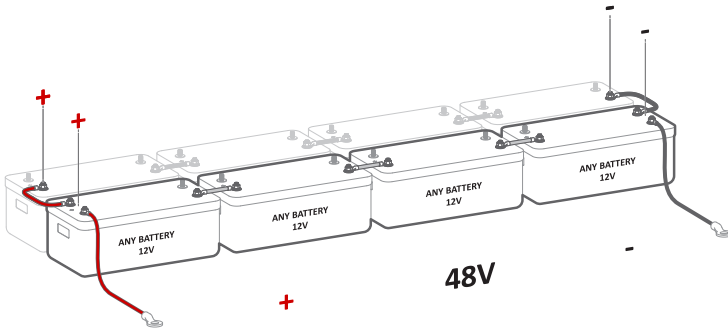
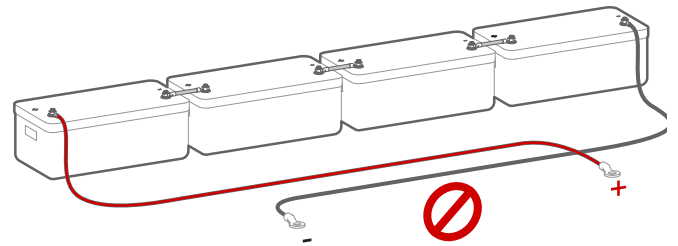

Figure 5c: Series and parallel connections for complete 48Vdc batteries bank



⚠️ **DO NOT reverse polarity. The system will be damaged, and warranty will be voided!**

### Battery Toroid

Install the battery toroid (provided) on battery input wires, as shown in the following figure. Battery (+) and (-) cables must go through the toroid simultaneously. These toroids are for EMI suppression

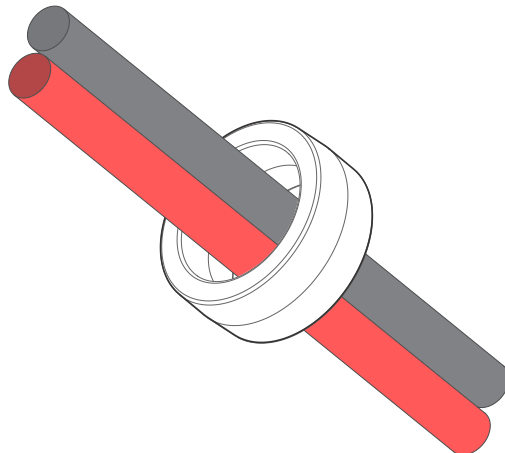

## Multi-Terminal Installation

The two battery input terminals of the MN 15-12KW-AIO will parallel batteries internally to ensure a common connection between battery banks and simplify battery installations. If a charge / discharge rate of 210A is needed, the batteries must be connected to both input terminals. If using 3 or more batteries, use external busbars or a MidNite Solar battery combiner for (+) and (-) connections.

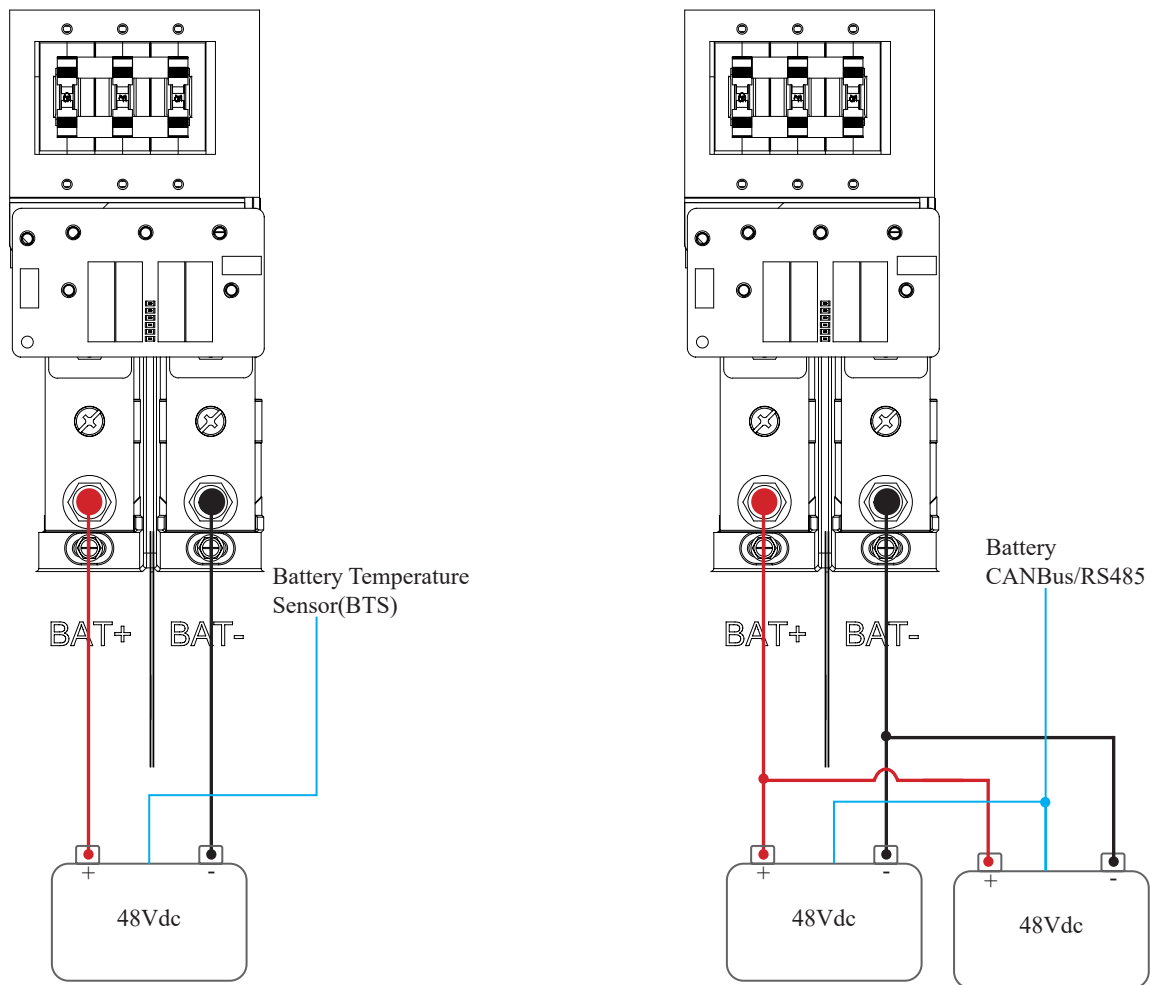

### IMPORTANT NOTE: Multi-system install

- A. ALL parallel inverters **MUST** connect to a single battery bank. The system will **NOT** operate properly on separate battery banks.
- B. **DO NOT** use separate battery banks in parallel systems.

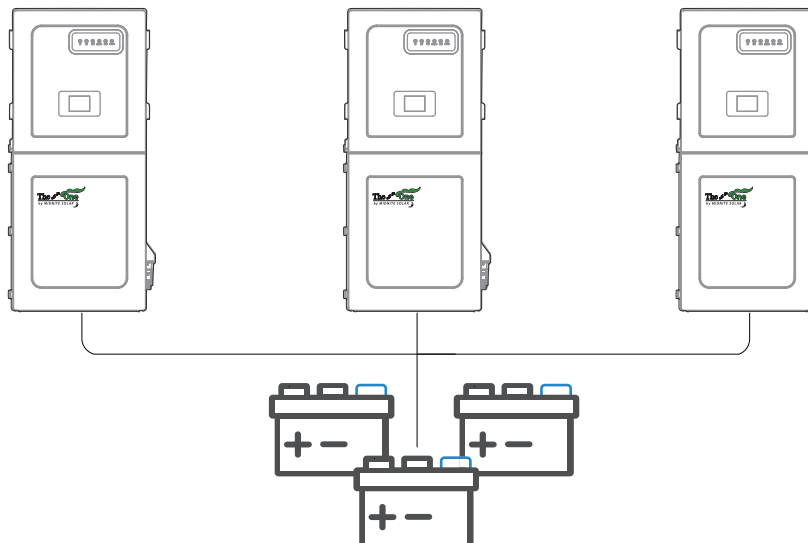

## 2.4 Integrating the Generator/Smart Loads/AC Coupling

### Generators Smaller than 10kW → On “GEN INPUT” Terminal

---

1. Supports 120/240V generators.
2. Connect the generator output to the “GEN INPUT” breaker terminal in of the wiring compartment. You must select the correct grid type before connecting the generator.
3. A THD (Total Harmonic Distortion) of less than 15% is preferred.
4. History tells us the biggest problem in renewable energy systems has the word "generator" involved. It is highly advised to use a generator intended for unattended operation. These generators are called "Prime Power Generators". Problems typically occur from portable generators that were never designed for this application. They can be identified easily. They have wheels and handles and don't cost much. Fortunately the charger in this inverter has shown to be very tolerant of portable generators.

### Smart Load→ On “SMART LOADS” Terminal

---

The MIDNITE MN 15-12KW-AIO is a system that supports the addition of smart load.

### AC Coupling→ On “AC COUPLING INPUT” Terminal

---

The MIDNITE MN 15-12KW-AIO is a system that supports the addition of AC coupled solar panels. The max solar input power can be expanded by coupling micro or string inverters into the “SMART LOADS” terminal. A full AC coupled solar system is not recommended as power control and monitoring is limited.

#### AC coupling on “AC COUPLING INPUT”

- a. Can produce solar power during a grid outage or Off-Grid systems.
- b. Can monitor solar production.

Max combined solar input AC= 12kW



In Off-Grid systems, MIDNITE uses Frequency Shift technology to shut down AC coupled solutions when the battery is full. Grid-Tied AC coupled solutions will always sell excess solar power back to the grid. “Limited to Load” will NOT limit production when AC coupled.

## 2.5 Automatic Generator Start

1. To charge the battery from the “GEN INPUT” source, the generator must be connected to the “GEN” input.
2. “Generator start SOC (%)” and “Generator end SOC (%)” or “Generator start Bat. Volt(V)” and “Generator start Bat. Volt(V)” are the set-point/condition that must be fulfilled to automatically start the generator.
3. (Default) Batteries will charge from a generator until the battery bank accepts 50% of its programmed capacity in Amperes (A). This is equivalent to around 50% of the state of charge (SOC). These settings are fully adjustable on your App.

## 2.6 Integrating Sensors and Accessories

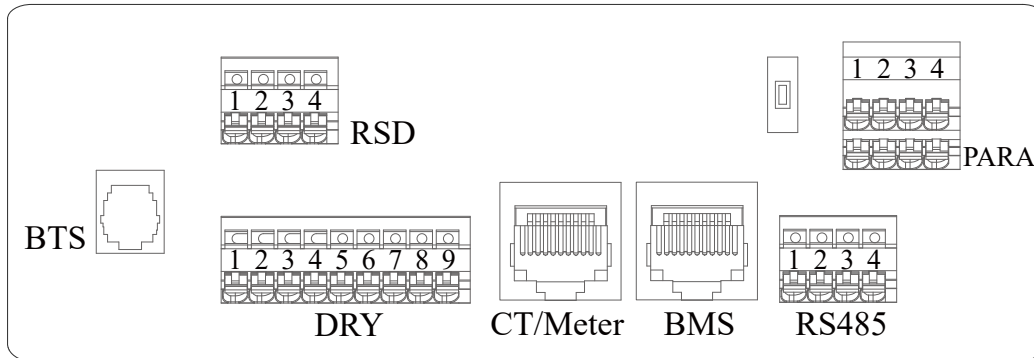

- **BTS**: Battery temperature sensor, not polarity sensitive. Used for voltage compensation for Lead Acid batteries. The standard MidNite MNBTS.
- **RSD**: Normally open dry contact for EPO (emergency power off). The built in transmitter is Sunspec compatible. MidNite Solar manufacturers String level Sunspec receivers that work with this inverter.
- **DRY**: Generator control, Remote off control, DI/DO control.
  - (1,2): Normally open relay for generator two-wire start.
  - (3,4,5,6): DI/DO control. (Digital input/output) Programmable through your App.
  - (7): Remote off control.
  - (8,+9): Temperature sensor terminal of lead-acid battery.
- **CT/METER**: CT/Meter communication or Grid current sense.
- **BMS**: Lithium battery communication interface.
- **PARA**: Parallel communication. A matched resistance switch for parallel communication.
- **RS485**: RS485 communication.



## BMS Port (CAN/RS485, Only for Lithium Battery)

- CAN BUS communication principle: CAN\_H to CAN\_H, CAN\_L to CAN\_L.
- Prepare RJ45 terminals and strip appropriate length of COM cables.
- Always face the flat side of the terminal, and count the pin slots from left to right from 1 to 8. Read the pin definitions of both the battery and inverter carefully.
- According to pin definitions and cable order, assemble the RJ45 terminals and crimp communication wires. Then label the RJ45 terminals (BAT or INV) to avoid confusion.
- After finishing wire-making, use a multimeter or other specific tool to determine if your cable is good, bad, or wired incorrectly.
- Insert the well-prepared communication cable into the correct inverter port and battery port respectively.
- CAN BUS connection principle:

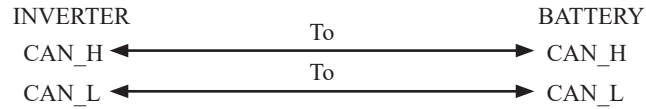

This manual ONLY illustrates the pinout sequence of BMS at INVERTER SIDE. For details about the pinout sequence at battery side, see the user manual of the battery you use, and the following pinout diagram of battery side is only for illustration.

Pin	RS485	CAN
1	RS485_A	--
2	RS485_B	--
3	GND_S	GND_S
4	--	CAN_H
5	--	CAN_L
6	GND_S	GND_S
7	GND_S	GND_S
8	GND_S	GND_S

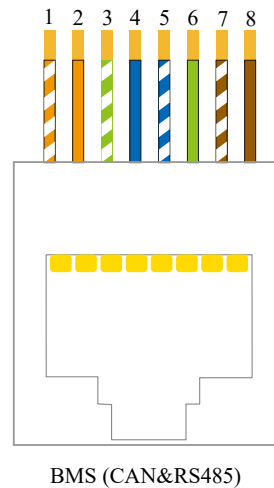

### Wi-Fi / Ethernet Antenna (Dongle)

- Remote monitoring and software updates require an internet connection through the WI -FI / Ethernet Antenna (Dongle).
- Compatible with Wi-Fi or Ethernet connections.

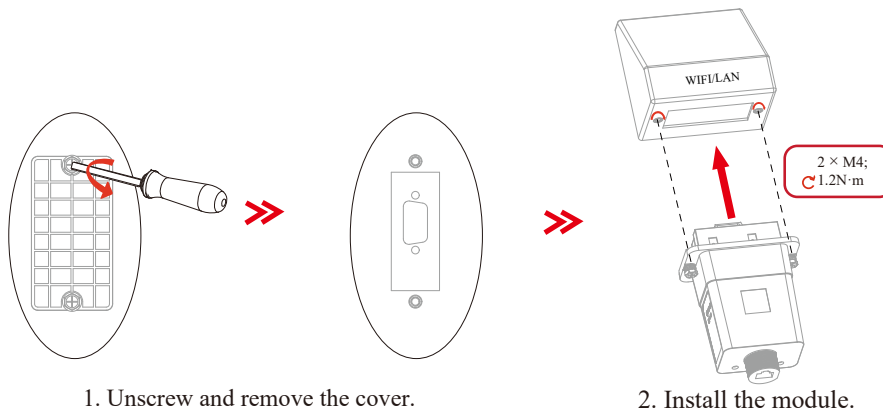

## GEN Start Signal (Two-wire start)

The signal comes from a normally open relay that closes when the generator “Start” condition is met

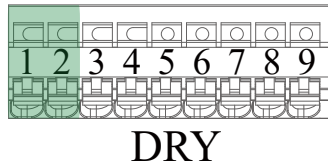

## 2.7 Limit Sensors (CT/Meter)

The CT/Meter will measure and calculate the demand in the Main Service Panel which the MIDNITE MN 15-12KW-AIO will then use to accurately supply and offset all home loads.

### CT/Meter Installation

- Install sensors on incoming electrical service wires on L1, L2 and L3 if system is 3- phase.
- Embossed arrows on the sensors must point towards the grid/inverter.
- To ensure proper fit, check incoming wire diameters (grid or generator). If the sensors are too small, bigger CTs can be purchased by calling sales: 360-403-7207 or contacting [sales@midnitesolar.com](mailto:sales@midnitesolar.com)
- See section “Work mode” for more information about the different work modes.
- See section “Wiring diagrams” for more information on CT/Meter installation.

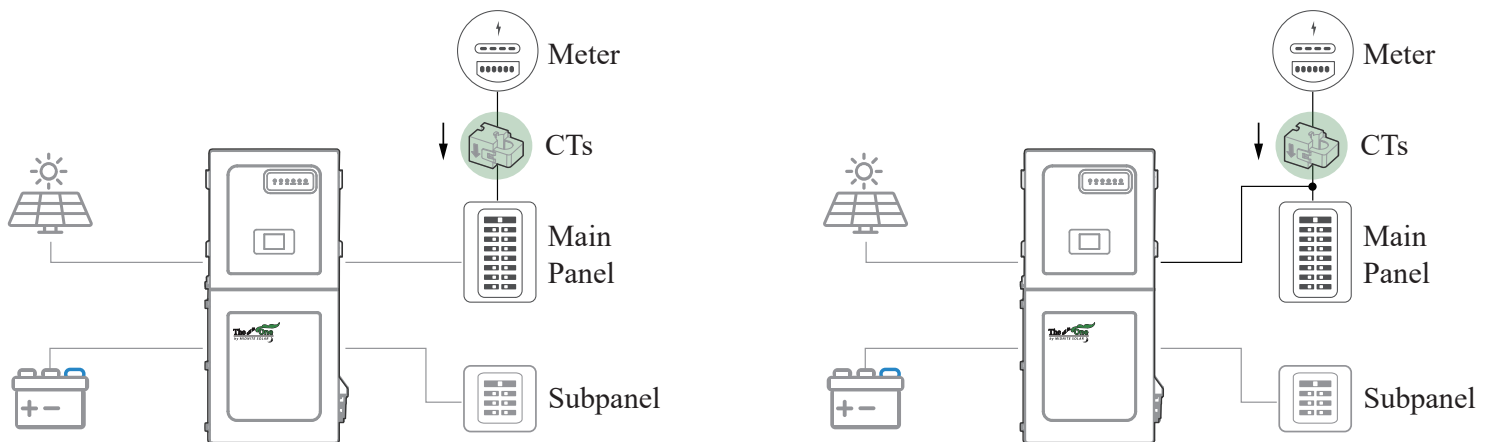

### CT Sensor Size

- MIDNITE includes two 0.94"(24mm) CT sensors (150A).
- MIDNITE offers one 0.94"(24mm) CT (500A) and one meter(DTSU666) upon request.
- Default CT ratio is 1:3000.



Unless authorized, DO NOT change CT Ratio or warranty will be voided



Wire gauge is the only metric used to determine size of CTs. Contact sales at 360-403-7207 to purchase bigger CT sensors

## Wiring the CT sensor

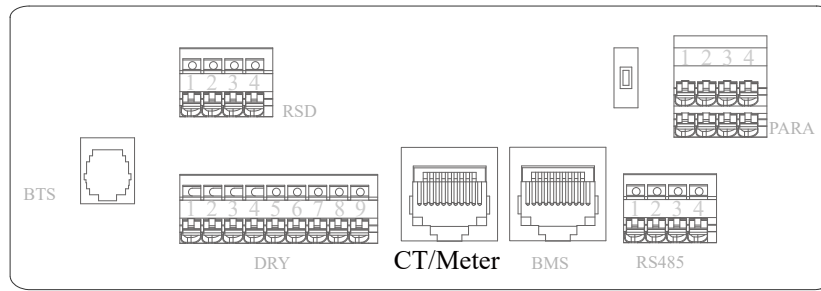

## CT Sensors for Stand-alone application 120V/240V Split phase

Each inverter will include two CT.

- Connect CT1 from phase L1 to pin 7 (White-Brown), 8 (Brown).
- Connect CT2 from phase L2 to pin 6 (Green), 5 (White-Blue).

Pin	Function Description
1	--
2	--
3	RS485_A
4	RS485_B
5	CT2-
6	CT2+
7	CT1+
8	CT1-

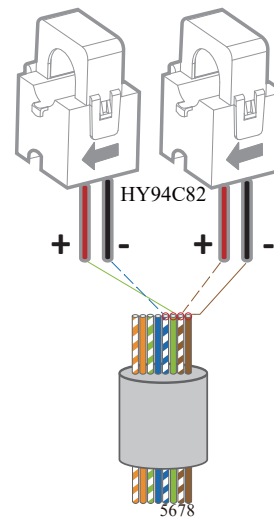

## CT+Meter for Parallel Systems 120V/240V Split phase

- CT+meter sensors are essential for stacking and highly recommended for multi-system installs.
- Please contact sales at 360-403-7207 to purchase the meter and bigger CT.

Pin	Function Description
1	--
2	--
3	RS485_A
4	RS485_B
5	--
6	--
7	--
8	--

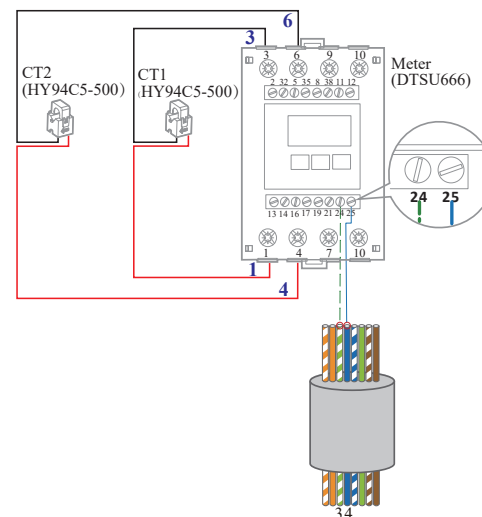

## CT+Meter for Parallel Systems 120V/208V Three-Phase

- The three-phase system requires three CTs and 1 meter.
- Please contact sales at 360-403-7207 to purchase the meter and bigger CT.

Pin	Function Description
1	--
2	--
3	RS485_A
4	RS485_B
5	--
6	--
7	--
8	--

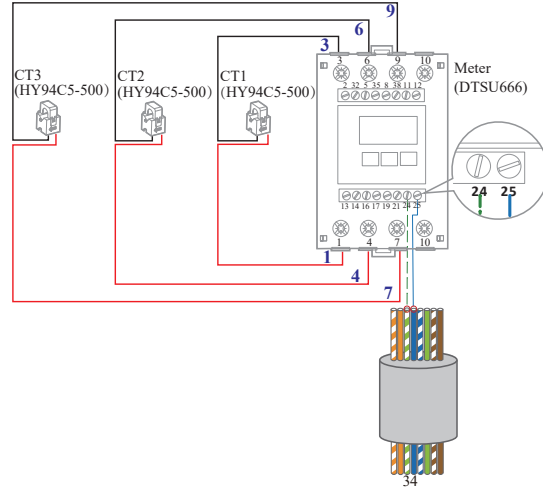

## 2.8 RS485

4-Pin interface for RS485 communication

Pin	Function Description
1	RS485_A
2	RS485_B
3	--
4	--

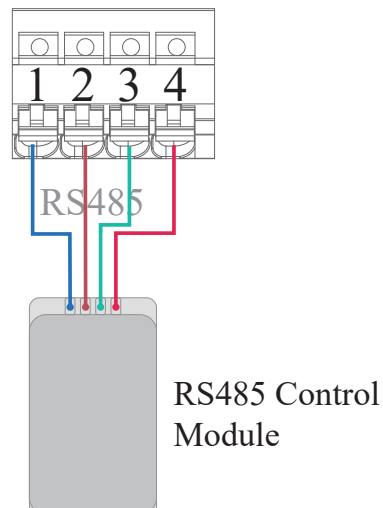

## 2.9 Parallel Communication

It is necessary to turn the matched resistance switch of No. 1 inverter and No. N inverter to “ON” in parallel connection mode.

Pin	Function Description
1	GND_S
2	PARA_SYNC
3	CAN_L
4	CAN_H

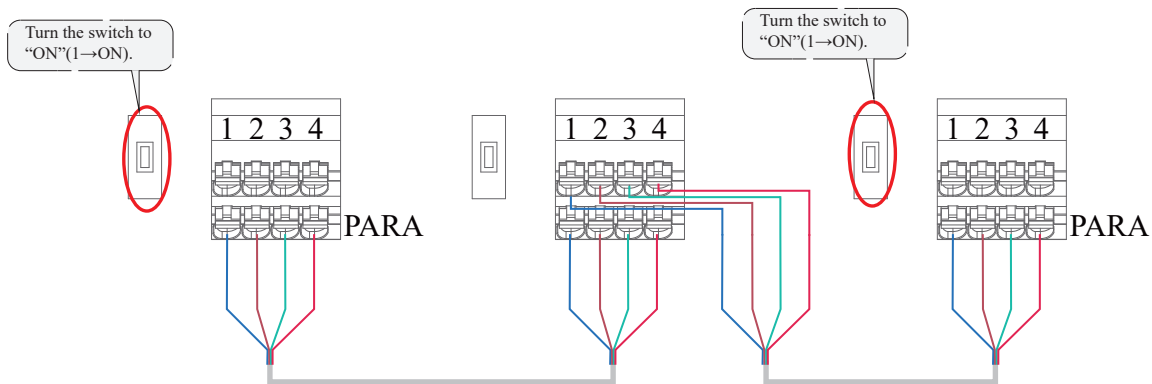

## 2.10 Emergency Stop and Rapid Shutdown

The (3,4) emergency stop pins of the MIDNITE MN 15-12KW-AIO are a normally open contact that triggers rapid shutdown (RSD) when closed. RSD will cut all power including the MIDNITE 's internal power supply and stop all AC outputs. The MIDNITE will disconnect any RSD transmitter that will then shutdown all solar panels when the emergency stop button is pressed.

- Emergency stop button connects to (3, 4) pins. A momentary switch will suffice. A shutdown and restart will be required after an RSD event.
- For parallel systems: the emergency stop should be connected to the inverter designated as “Inverter N1” and it will initiate rapid shutdown on all paralleled inverters.
- Pins 1 & 2 are already wired to the Sunspec transmitter.

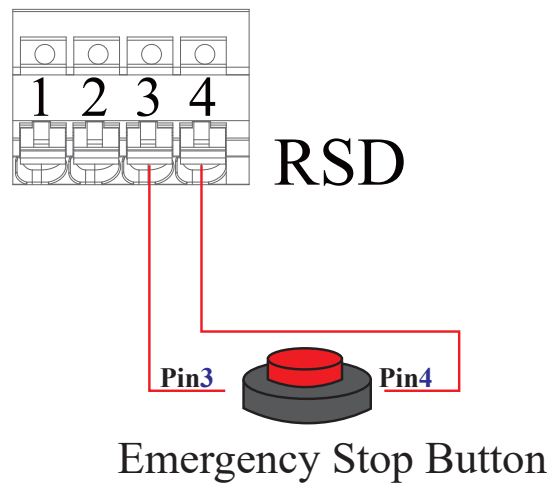

## 2.11 Powering-up and Testing the MIDNITE

### 1. Check the voltage of the battery bank

- ⚠ Voltage of the battery must be between 40Vdc-64Vdc.
- If applicable, turn **ON** internal switches of the batteries. Measure individual voltages.
- Verify that the voltage of the battery bank at the battery terminals is adequate.

### 2. Check the voltage of each PV input circuit

- ⚠ Input voltage must not exceed 600Vdc. Damage to the inverter will result.
- Input voltage must be above the startup voltage of 90Vdc.
- ⚠ Do not ground PV+ or PV-. Damage to the inverter will result.
- ⚠ Verify polarity in each PV string. Backward polarity will measure 0Vdc by the inverter and will cause long term damage.
- 📱 PV input will only turn on the LCD screen. Inverter requires **grid power** or **batteries** to start inverting.
- PV DC disconnect switch on the side of the inverter will turn the PV ON or OFF.

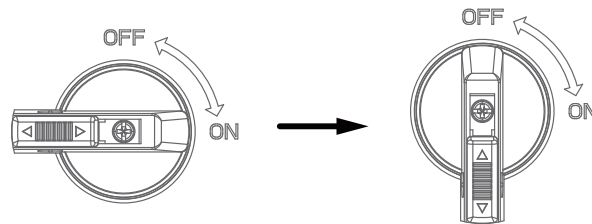

### 3. Check AC INPUT GRID input voltage with breakers off

- Use the breaker terminal lugs to measure AC voltages with a multimeter.
- Measure line (L) to neutral (N) voltages on “AC INPUT GRID” terminal. Ensure 120Vac on both legs.
- Measure line (L1) to line (L2) voltage on “AC INPUT GRID” terminals. Ensure 240Vac. (If voltage reading is close to 220V or 210V, verify if grid is single-phase or three-phase instead).
- Verify that voltage between neutral and ground is 0Vac. 📱 Stray parasitic capacitance in wiring may show low voltages present.
- Verify that voltage between “AC INPUT GRID” L1 and “AC OUT” L1 is 0V. Do the same for L2.

### 4. Power ON MIDNITE MN 15-12KW-AIO

- Power on the PV.
- Power on the battery from the battery breaker and any external battery switches or breakers.
- Power on the AC IN GRID breaker.
- Connect the cell phone App via Bluetooth. And click the Power ON in the App for the first time. Or you can hold the ON/OFF button on the side of the inverter for 5s in this step when performing subsequent startup. Cell phone app instructions are on the side of the inverter & on the quick start guide.
- Power on the AC OUT breaker.
- Power on the SMART LOAD breakers
- Please wait 5 minutes for the inverter to start as it makes systems checks.**
- 📱 **When changing modes or changing smart load settings, you must put the inverter in standby and wait 5 minutes to restart.**
- 📱 **If an error is identified, you must clear the error to recover and wait 5 minutes to restart.**

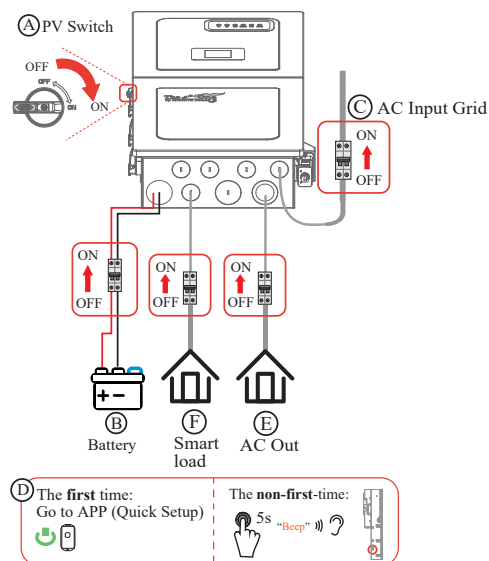

## 2.12 Power Off Sequence

- A. Power off the AC OUT breakers.
- B. Power off the SMART LOAD breakers
- C. Connect the cell phone App via Bluetooth. And click the Power OFF on the App. Or you can hold the ON/OFF button on the side of the inverter for 5 seconds in this step when performing subsequent shutdown
- D. Power off the AC IN GRID breaker.
- E. Power off the battery from the battery breaker and any external battery switches or breakers.
- F. Power off the PV.
- G. To disconnect the inverter cables, please wait at least **5 minutes** before touching them.

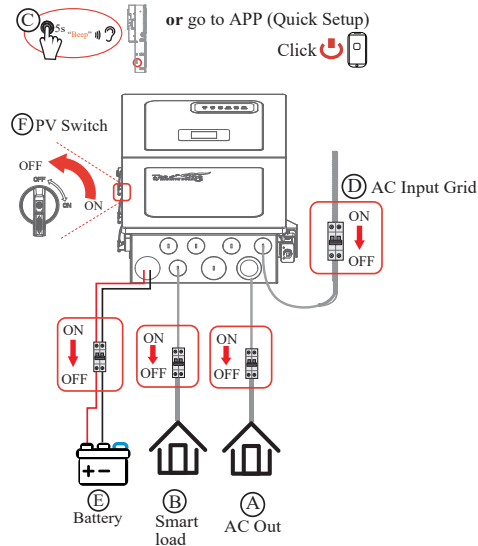

## 2.13 LED Indicators

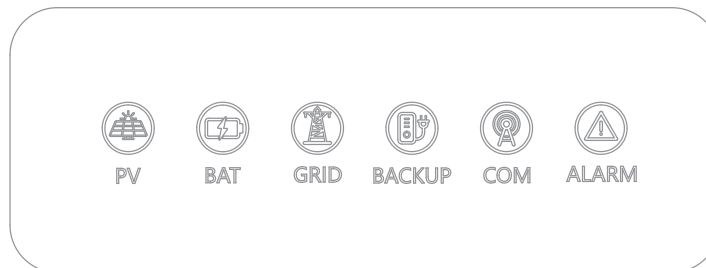

PV	BAT	GRID	COM	BACKUP	ALARM
On →PV input is normal.	On →Battery is charging.	On →GRID is available and normal.	-	On →BACKUP power is available.	On →Fault has occurred and inverter shuts down.
Blink →PV input is abnormal.	Blink →Battery is discharging. Battery is abnormal.	Blink →GRID is available but abnormal.	Blink →No data transmission.	Blink →BACKUP output is abnormal.	Blink →Alarms have occurred but inverter doesn't shut down.
Off →PV is unavailable.	Off →Battery unavailable or battery type not selected.	Off →GRID is unavailable.	Off →Grid unavailable or set to off grid mode.	Off →BACKUP power is unavailable.	Off →No fault.

 \*Fully energizing the unit constitutes at least: a) DC Solar panels AND Grid or b) Just batteries

## 2.14 LCD screen







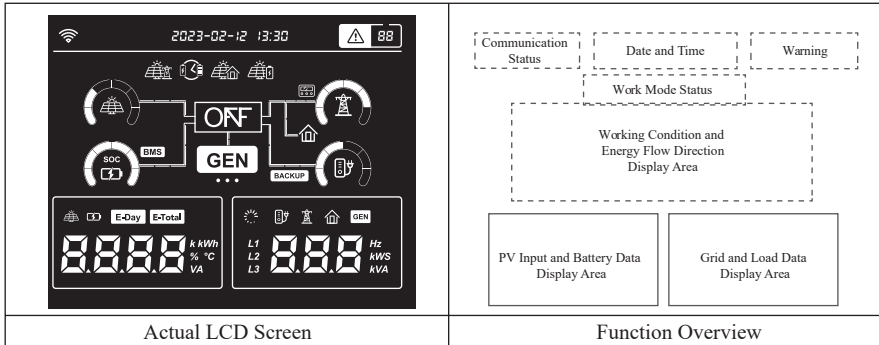









LCD screen is optional for this series of inverters. If you choose a LCD screen, the following introduction will help you understand the function of each icon displayed.

 LCD screen will be automatically turned off if there is no operation within 10 mins (which cannot be changed by default). You can tap the ON/OFF button on the side of inverter to wake up the LCD screen.

### Menu Structure Overview



### Icon Introduction-1

	This icon indicates <b>WIFI</b> connection status.
	The <b>date and time</b> display information of year, month, day, and hour-time. The ':' between hour and minute flashes once a second.
	<b>Warning icon</b> only displays when the error occurs. For specific warning code explanation, please refer to the chapter Inverter Troubleshooting.
	These four icons show <b>different operating status</b> . Please refer to chapter Inverter Working Mode for detailed introduction.  <b>Grid Feed in priority(Sell to grid)</b>  <b>Self Consumption</b>  <b>TimeBase Control Function</b>  <b>Off Grid</b>
	This area shows the <b>working conditions and energy flow directions</b> . Please refer to <a href="#">Table Icon Status Description</a> for detailed introduction of each icon displayed.
	The <b>Energy Bars</b> indicate energy flow direction. Each bar lights up one by one, then turns off when all bars light and repeats this cycle again.
	The <b>Energy Ring</b> indicates the battery SOC or the current power percentage. Each Energy Ring definition is as follows.  PV Input Power  <b>On-Grid Mode:</b> Grid Output Power <b>Non On-Grid Mode:</b> Bypass load consumption power + Backup consumption power  Battery SOC  Backup
	 Grid overvoltage



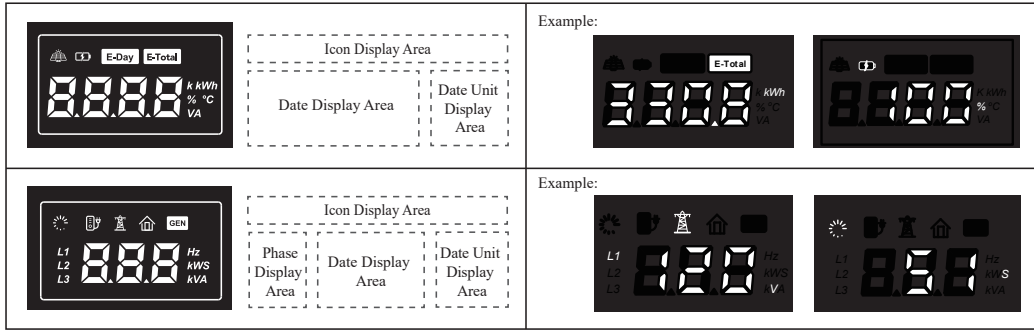















## Icon Introduction-2

	The <b>PV icon</b> represents the power of PV.
	The <b>Battery icon</b> represents the current battery charge percentage or the voltage of battery.
	The <b>E-Today icon</b> represents the electricity energy generated today.
	The <b>E-Total icon</b> represents the electricity energy generated in total.
	When the <b>Loading icon</b> is on, it represents that the device is starting and the start timer countdown is displayed. The icon lights up a cluster of lights every second, until all lights are on, and then repeat the whole process again.
	The <b>Back-Up icon</b> represents the relevant power, frequency or voltage of Back-Up.
	The <b>Grid icon</b> represents the relevant power, frequency or voltage of the Grid.
	The <b>Load icon</b> represents the power consumption.
	The <b>GEN icon</b> represents the voltage or power of generator.
	The <b>L1 icon</b> represents L1 phase of Grid/Backup/Generator. The <b>L2 icon</b> represents L2 phase of Grid/Backup/Generator. The <b>L3 icon</b> represents L3 phase of Grid/Backup/Generator.
	These two areas will display corresponding data of each lit icon mentioned above.

## Icon Status Description

Icon Status Description			
Icon	Name	Light	Description
	PV	ON	Any PV voltage exists ( it should be higher than the Min. PV Startup Voltage) .
		OFF	PV Voltage is lower than the Min. PV Startup Voltage.
	Grid	ON	Grid Voltage and frequency are normal.
		OFF	Grid overvoltage / undervoltage / overfrequency / underfrequency occurs.
	Battery	ON	Bat. Voltage is higher than the Rated Min. Bat Voltage.
		OFF	Bat. Voltage is lower than the Rated Min. Bat Voltage.
	Back-Up Load	ON	Backup relay is on.
		OFF	Backup relay is off.
	BMS	ON	Battery is set to BMS Type and its communication is normal.
		Blink	BMS communication is abnormal.(The icon indicator on for one second, off for one second)
		OFF	1. Battery is not set to BMS Type. 2. Battery voltage is lower than Rated Min. Voltage
	BACKUP	ON/OFF	Lights up/off with Back-Up Load icon simultaneously
	Meter/CT	ON	Power Limit is set to CT or Meter in APP, and the CT/Meter communication is normal, the Grid side is running well.
		Blink	When Meter/CT communication is lost, Meter/CT icon on for one second, off for one second)
		OFF	1. Power Limit is not set to CT or Meter. 2. The voltage or frequency of grid side is abnormal.
	Load	ON/OFF	Lights up/off with Grid icon simultaneously.
	ON	ON	1. Backup relay is on. 2. The inverter works under On-Grid mode. 3. The inverter works under Off-Grid mode.
	OFF	OFF	Non-on working mode.
	Generator / Smart Load / Inverter	From left to right, when the three dots light up, each represents different meanings.	
		When GEN communication is lost, GEN icon will go off.	
	GEN	ON	Generator relay is on.
		OFF	Generator relay is off.
	Generator dot	ON	In APP, the "Gen port" parameters set to "Generator Input" and the generator relay is powered on.
		OFF	APP parameter set to Non 'Genetator Input'.
	Smart Load dot	ON	In APP, the "Gen port" parameters set to "Smart Load Output" and the generator relay is powered on.
		OFF	APP parameter set to Non 'Smart Load Output'.
	Inverter dot	ON	In APP, the "Gen port" parameters set to "Invertre Input" and the generator relay is powered on.
		OFF	APP parameter set to Non 'Inverter Input'.

# 3. App Setting Guide

## Download App for Local Setting

- Scan the QR code to download the App MidNite Pro.



- Download the APP from the App Store or Google Play

## Access Permission

Before using the local setting, the APP should access some permissions. (You can allow them when you install the APP or grant permissions in your own phone setting.) When the APP asks for permission, please click Allow.

## Connect Inverter

Firstly, open the bluetooth and the APP on your phone. Then connect the inverter.

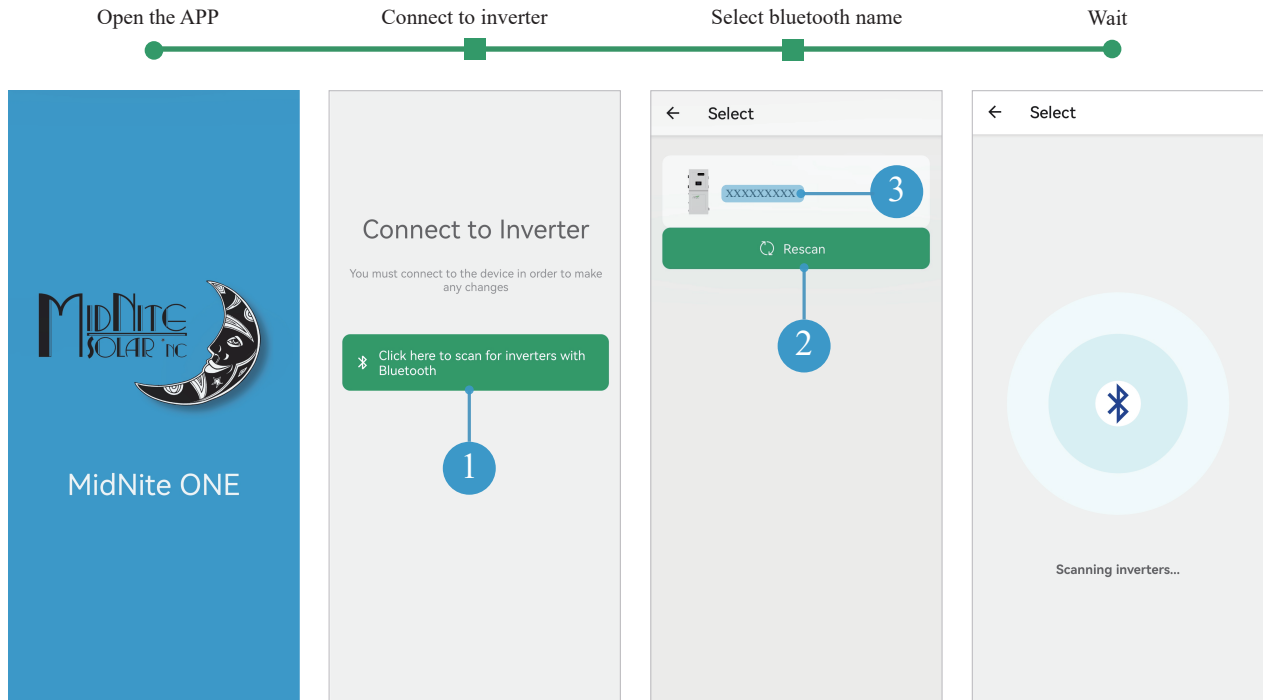

## 3.1 Installer login

Select the installer role to log in.

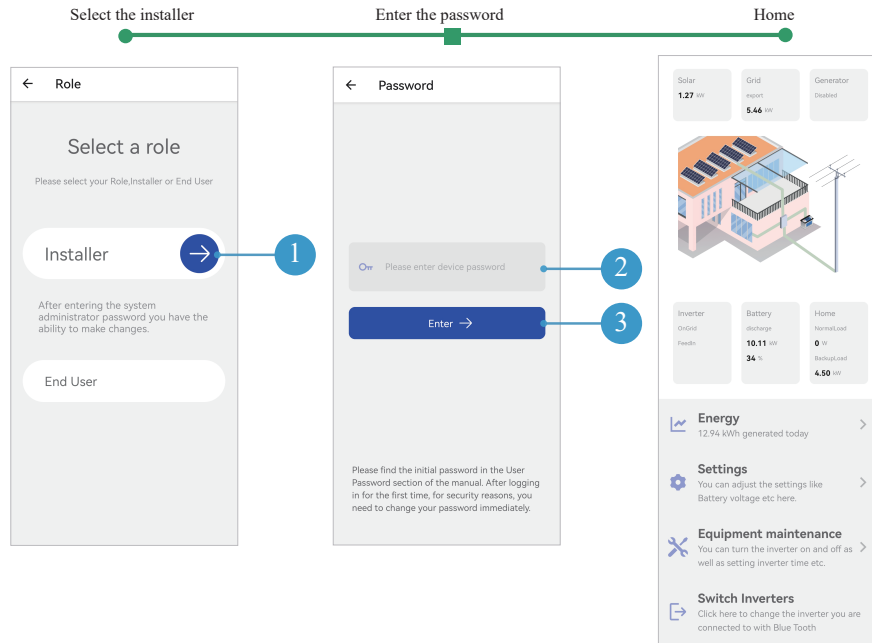

## 3.2 Stored energy

- A. Set the work mode.
- B. If the user want to sell back, please disable the Zero Export button.
- C. Set the related battery parameters.
- D. Set smart load, generator or AC coupling parameters.
- E. Enable the TimeBase Control function.

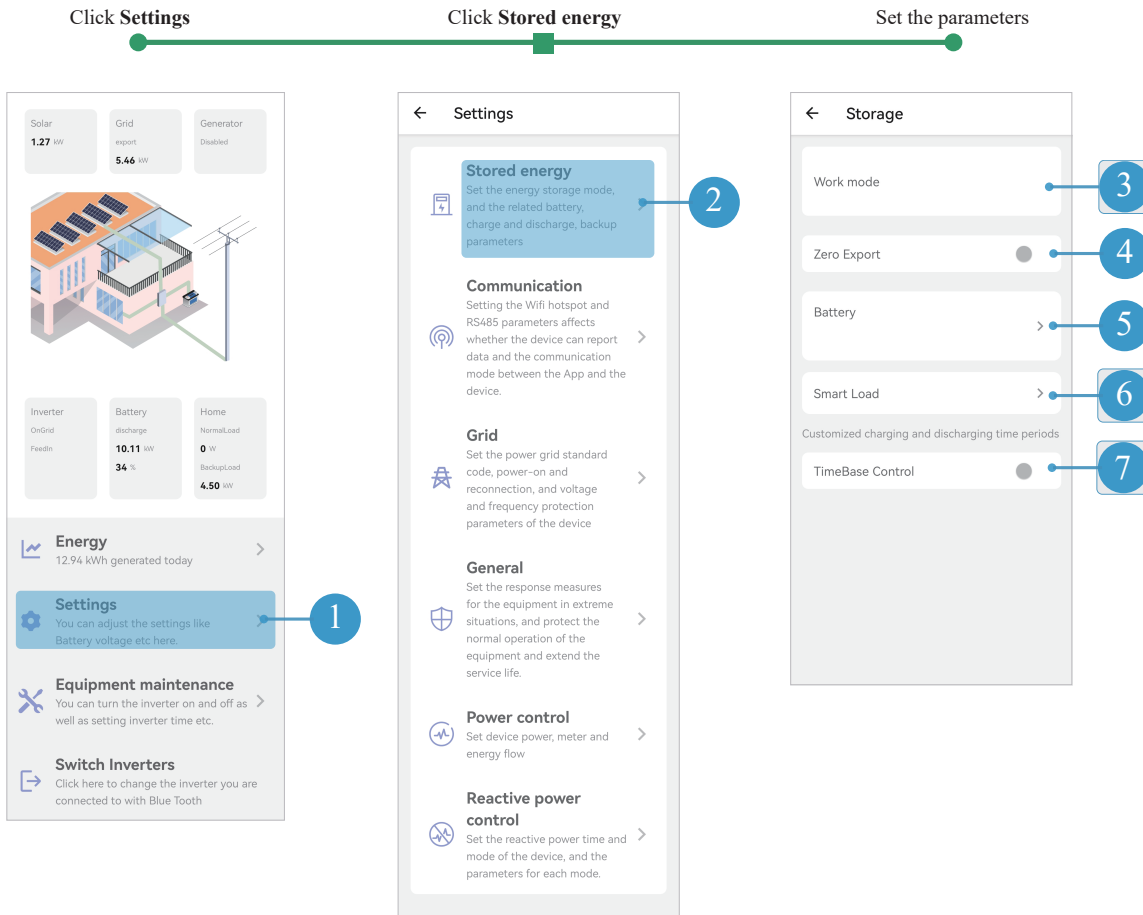

### 3 Work Mode

## Self Consumption

Select the "Self Consumption".

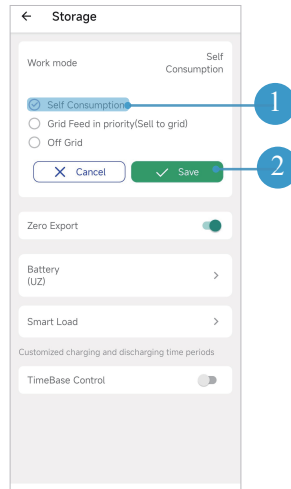

Under Self consumption mode, the priority of PV energy consumption will be Load > Battery > Grid, that means the energy produced by PV gives priority to powering local loads, the excess energy is used to charge the battery and the remaining energy is fed into the grid if the user has the permit to sell back.

This is the default mode to increase self consumption rate. There are several situations of self-consumption working mode based on PV energy.

#### a) Excess PV Energy

When PV energy is abundant, the PV energy will be first consumed by loads, the excess energy will be used to charge the battery and then the remaining energy will be fed into the grid if the user has the permit to sell back.

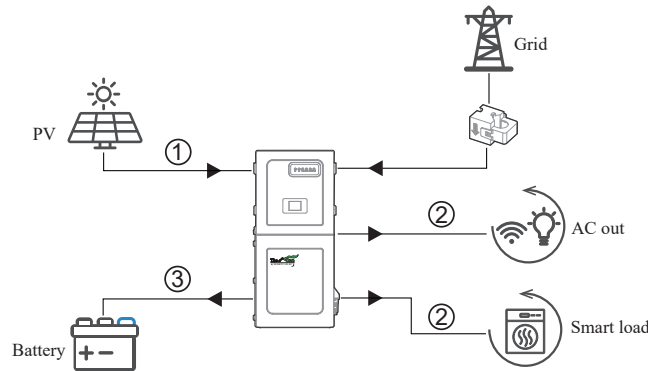

① ② ③ is the sequence of PV energy transmission.

#### b) Limited PV Energy

When the PV energy is not enough to cover all consumption, the PV energy will be entirely used by loads, and the insufficient part will be supplied by battery. Then still insufficient parts will be supplied by grid.

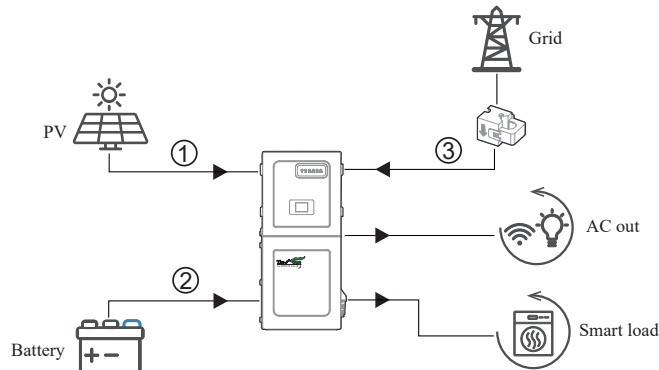

① ② ③ is the sequence of loads consumption.

### c) No PV Input

The inverter will first discharge the battery energy for home load consuming when no PV input( such as in the evening or some cloudy or rainy days). If the demand is not met, the loads will consume grid energy.

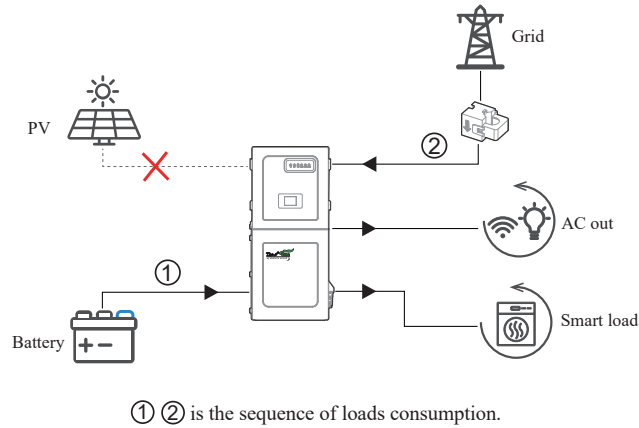

### Grid Feed in priority(Sell to grid)

Select the "Grid Feed in priority(Sell to grid)".

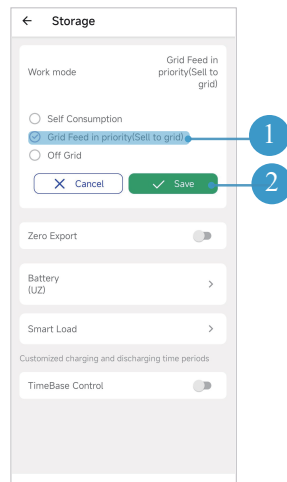

Under this mode, the priority of PV energy consumption will be Load > Grid > Battery, that means the energy produced by PV gives priority to powering local loads, the excess energy is fed into the grid, and the remaining energy is used to charge the battery.

#### a) Excess PV Energy

When PV energy is abundant, the PV energy will be first consumed by loads. If there is excess PV power, the power will be fed into grid. If there is still PV energy left after load consuming and grid feeding, then the remaining PV power will be used to charge the battery.

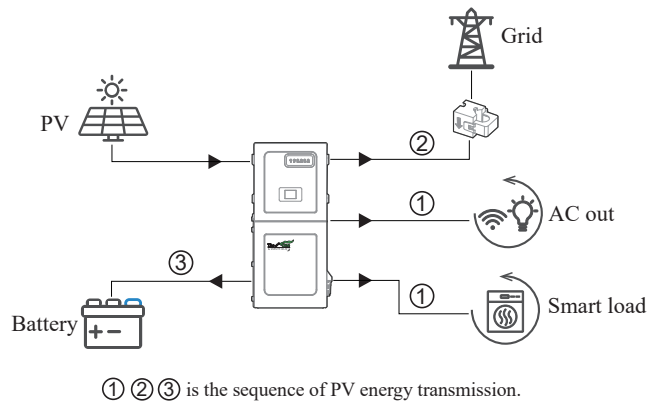

### b) Limited PV Energy

When PV energy is limited and cannot meet the feed-in grid power, the battery will discharge to meet it.

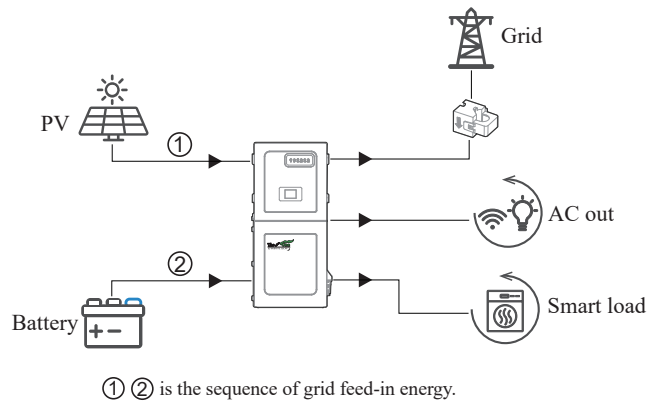

### c) No PV Input

The inverter will first discharge the battery energy for home load consuming when no PV input (such as in the evening or some cloudy or rainy days). If the demand is not met, the loads will consume the grid energy.

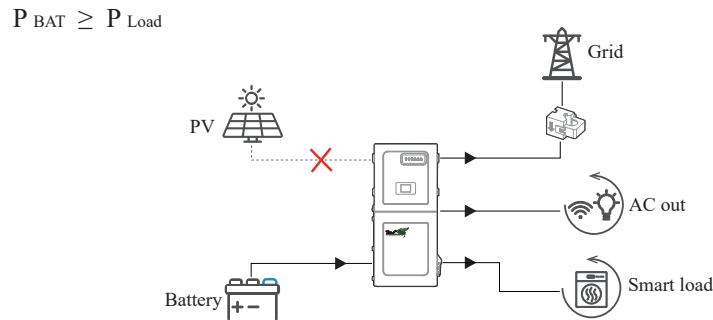
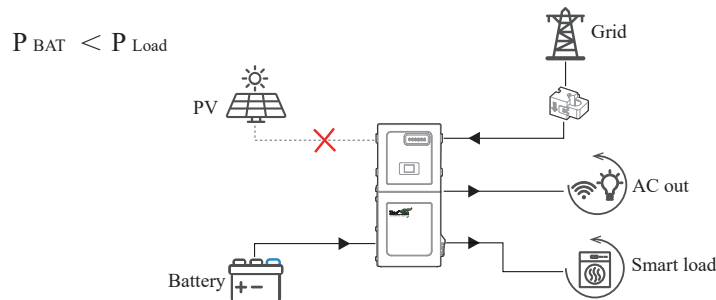

## Off Grid

Select the "Off Grid".

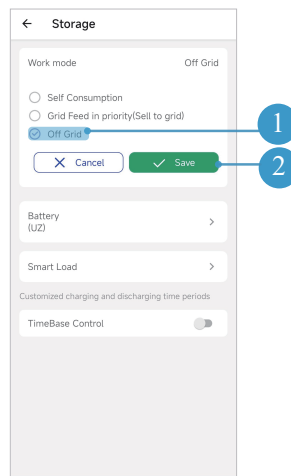

Under this mode, the priority of PV energy consumption will be Battery > Load, and the battery can be charged both with PV and generator. This mode aims at charging the battery quickly, and at the same time, you can choose whether to allow generator to charge the battery.

**a) Excess PV power**

When PV energy is abundant, PV meets the loads first, then charges the battery.

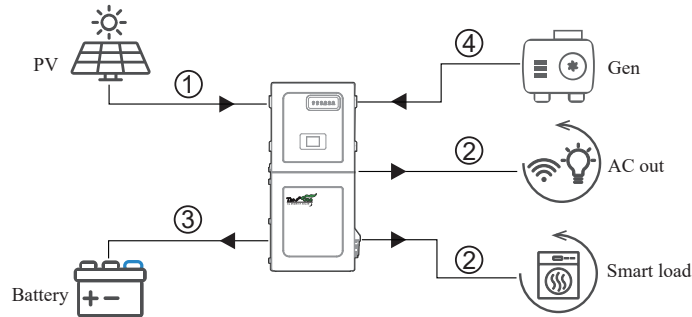

① ② ③ ④ is the sequence of PV energy transmission.

**b) Limited PV power**

When the PV energy is not enough to charge the battery, the generator will charge the battery and feed the loads as supplement.

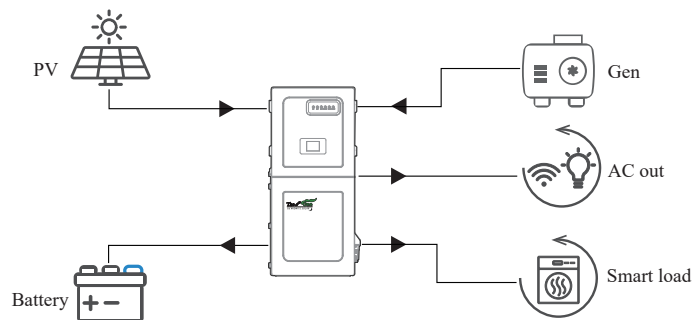

## 6 Smart Load

### Smart Load

There are three terminals are available.

**Smart load start and stop by battery SOC:** The battery SOC exceeds/lower than the value, the smart load start/stop.

**Smart load start and stop by battery voltage:** The battery voltage exceeds/lower than the value, the smart load start/stop.

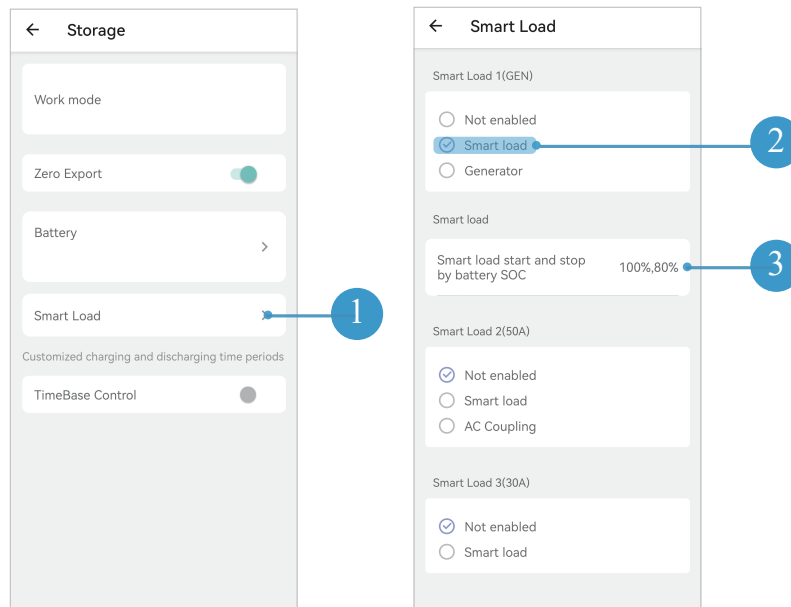

Go to **Battery** interface, set the value of **Capacity Mode** to switch between smart load start and stop by battery SOC or voltage on the **Smart Load** interface. Yet, under this mode the Inverter Input function still follows the running logic you set.



## Generator

**Maximum Input power from Generator:** Forbid the generator power larger than the setting value.

**Maximum GEN charge power:** Maximum battery charge power from generator.

**Generator start and stop by battery SOC:** The battery SOC lower than/exceeds the value, the generator start/stop.

**Generator start and stop by battery voltage:** The battery voltage lower than/exceeds the value, the generator start/stop.

**Standby and MaxRun Time:**

- **MaxRun Time:** When the generator's running time reaches to the maxrun time setting value, the inverter will disconnect the input from generator. But the generator will keep working for a while defined by standby time.
- **Standby Time:** When the inverter disconnects the input from generator, the generator will keep working for a while by the standby time setting value.
  - For generator that switch on and off by dry contact, it will stop working automatically when the generator working time reaches to the standby time setting value.
  - For generator that are manually switched on and off, it will stop working by manual regardless of the standby time setting value.

**Dry Force:** When the grid power is abnormal, the generator is forced to be turned on.

**Run Cycle:** Generator Cycle run mode. You can set as Weekly or Month cycle.

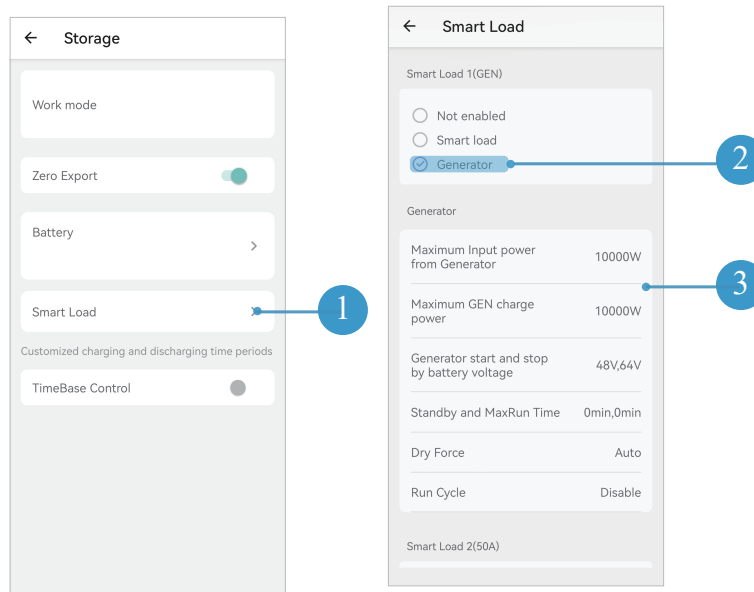

Go to **Battery** interface, set the value of **Capacity Mode** to switch between Generator start and stop by battery SOC or voltage on the **Smart Load** interface. Yet, under this mode the Inverter Input function still follows the running logic you set.

## AC coupling

**AC Coupling start and stop by battery SOC:** The battery SOC lower than/exceeds the value, the AC coupling start/stop.

**AC Coupling start and stop by battery voltage:** The battery voltage lower than/exceeds the value, the AC coupling start/stop.

**Off-network output maximum frequency:** This parameter is used to limit the output power of grid-tied inverter when the hybrid inverter works under off-grid. As the battery SOC gradually reaches to the setting value (stop), during the process, the grid-tied inverter output power will decrease linear. When the battery SOC equal to the setting value (stop), the system frequency will become the setting value (**Off-network output maximum frequency**) and the grid-tied inverter will stop working.

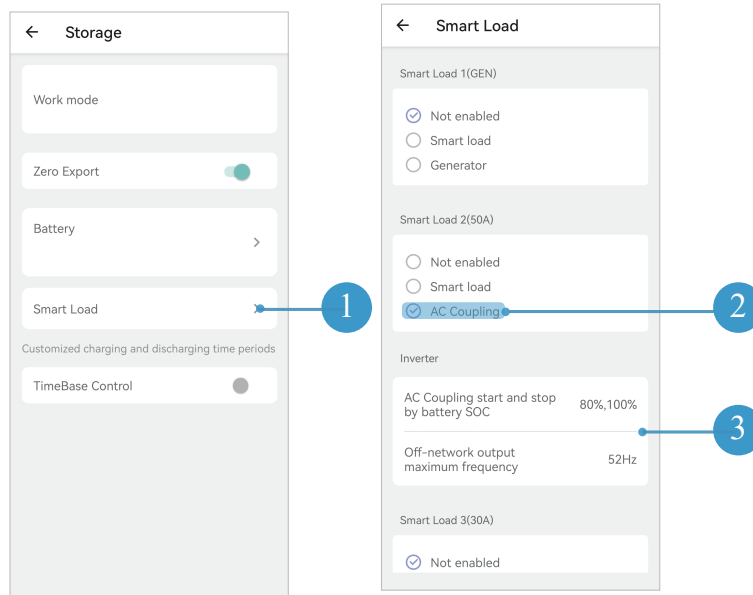

Go to **Battery** interface, set the value of **Capacity Mode** to switch between AC coupling start and stop by battery SOC or voltage on the **Smart Load** interface. Yet, under this mode the Inverter Input function still follows the running logic you set.

Logic Diagram of Start/Stop Smart Load/Generator/AC Coupling Port Function(by Battery SOC)

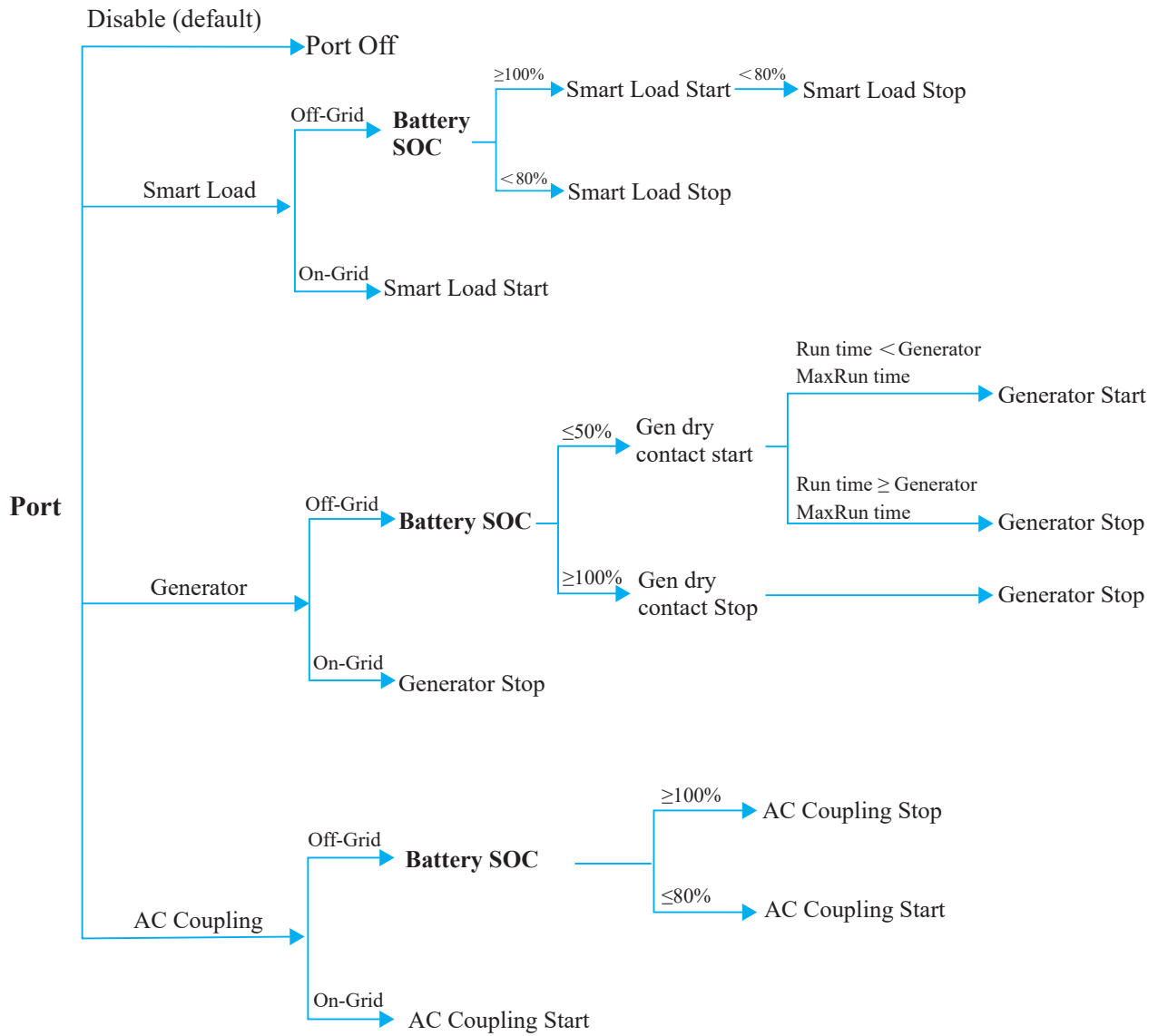

- When the Capacity Mode was set to voltage, the Smart Load/Generator/AC Coupling still follows the above logic.
- The data in the figure are illustrative.

Logic Diagram of Start/Stop Smart Load/Generator/AC Coupling Port Function(by Battery Voltage)

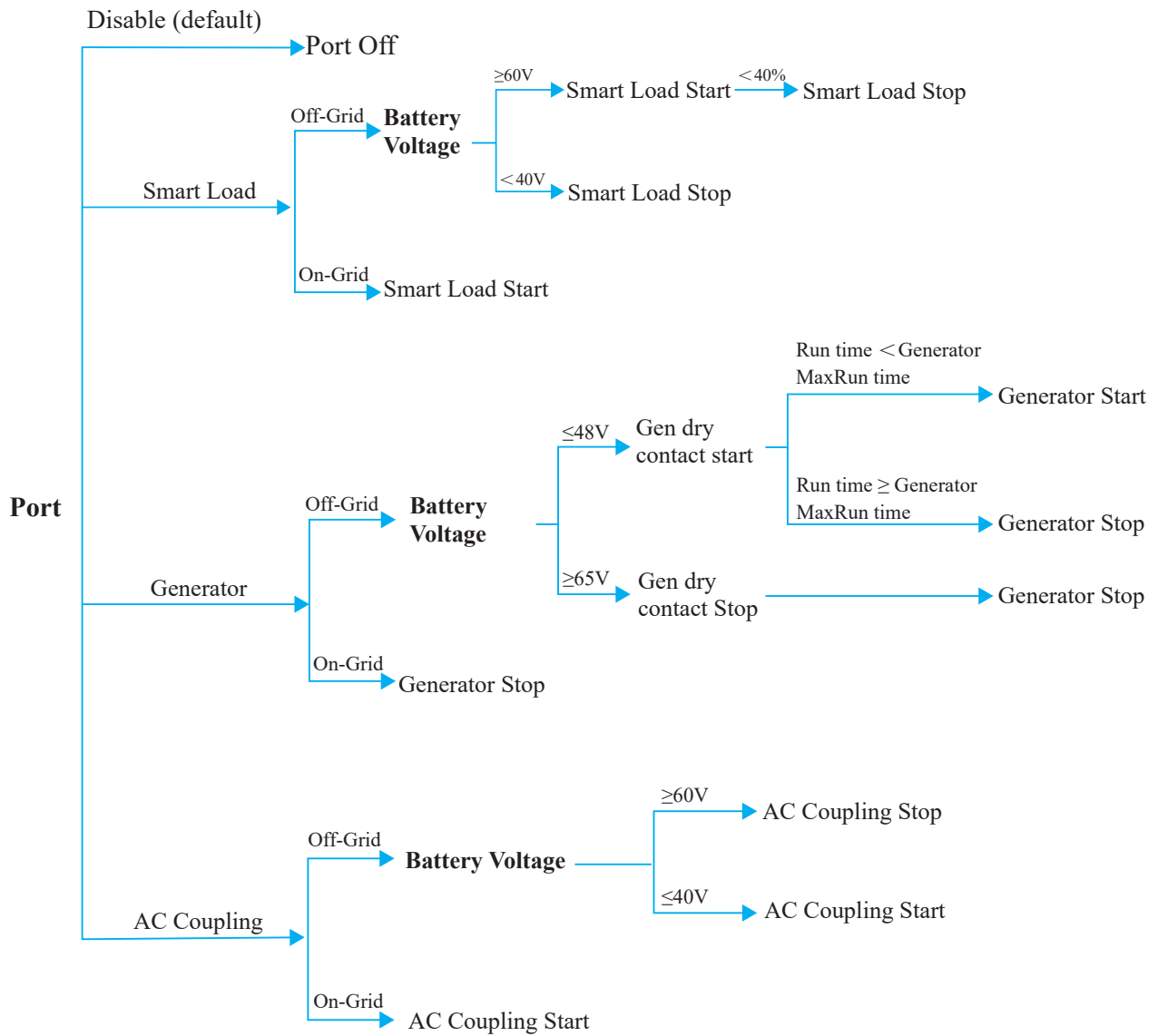

- When the Capacity Mode was set to SOC, the Smart Load/Generator/AC Coupling still follows the above logic.
- The data in the figure are illustrative.

## 7 TimeBase Control

The TimeBase Control(Forced Charge/Discharge) function is designed to control the time setting of charging and discharging the inverter. According to the demands of application, the user can set the inverter to work on forced charge/discharge the battery in any working mode.

There are three time periods in which you can set this function. Outside of the set periods, the inverter returns to its original working mode. The forced charge/discharge function has the highest priority.

The relationship between the forced charge/discharge function and working mode shown as below.

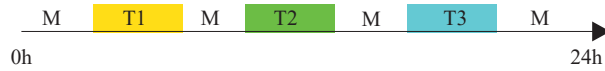

M : Self-consumption Mode/Feed-in Priority Mode/Back-up Mode

T1: Time period 1 for forced charge/discharge parameter setting

T2: Time period 2 for forced charge/discharge parameter setting

T3: Time period 3 for forced charge/discharge parameter setting

T1, T2, and T3 priority to M.

Charge and discharge frequency: one time or daily

- Charging start time: 0 to 24 hours
- Charging end time: 0 to 24 hours
- Discharge start time: 0 to 24 hours
- Discharge end time: 0 to 24 hours

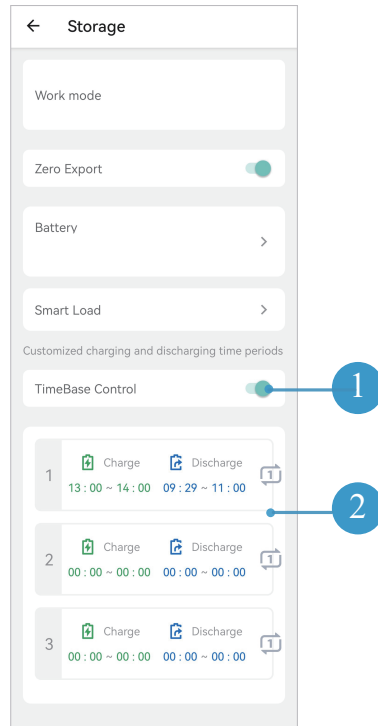

## 3.3 Communication

Connect to the router.

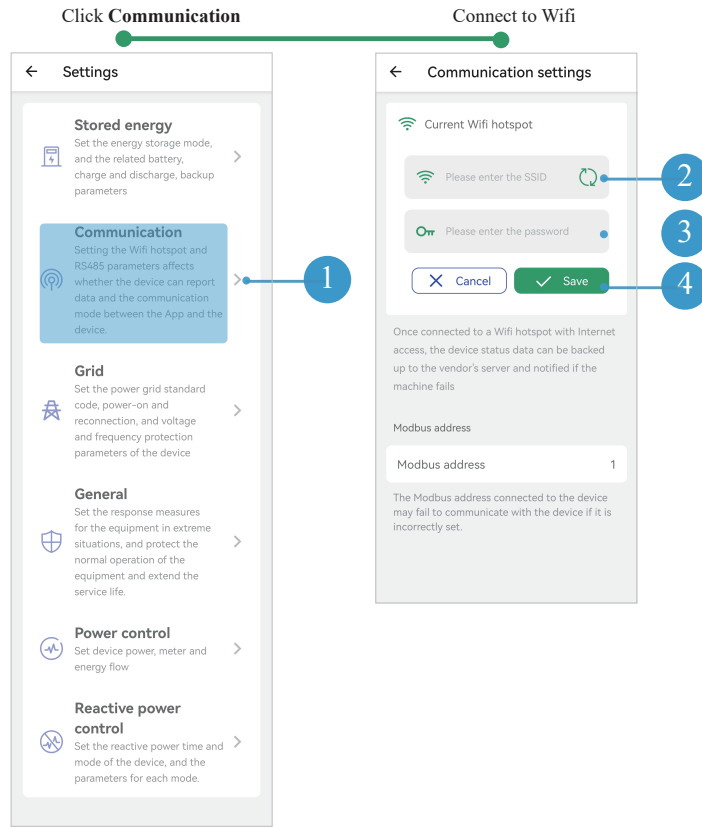

## 3.4 Grid

Set the grid parameters.

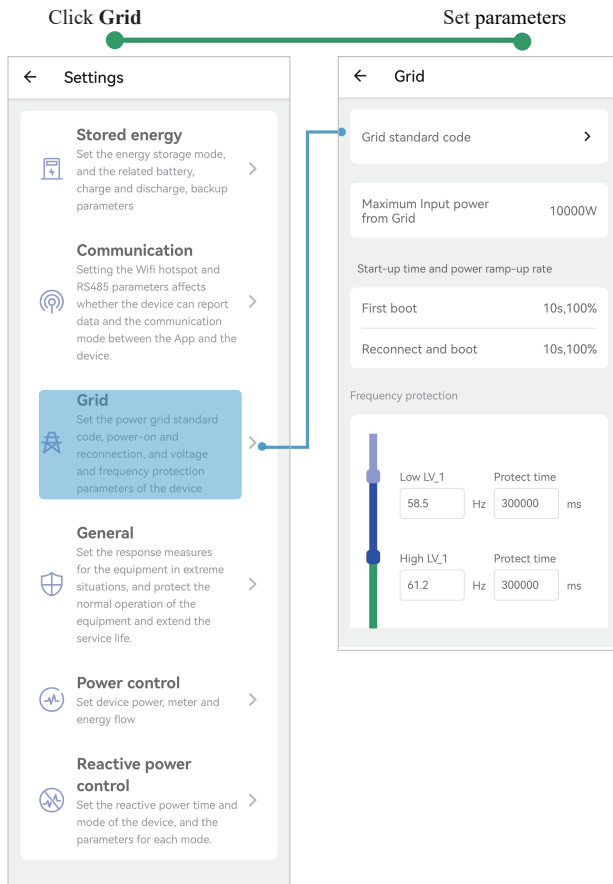

## 3.5 General

Set the protection measures, and other (options including Grid Voltage type, Buzzer, DRM Function, Parallel mode listed). Enable or set them when necessary.)

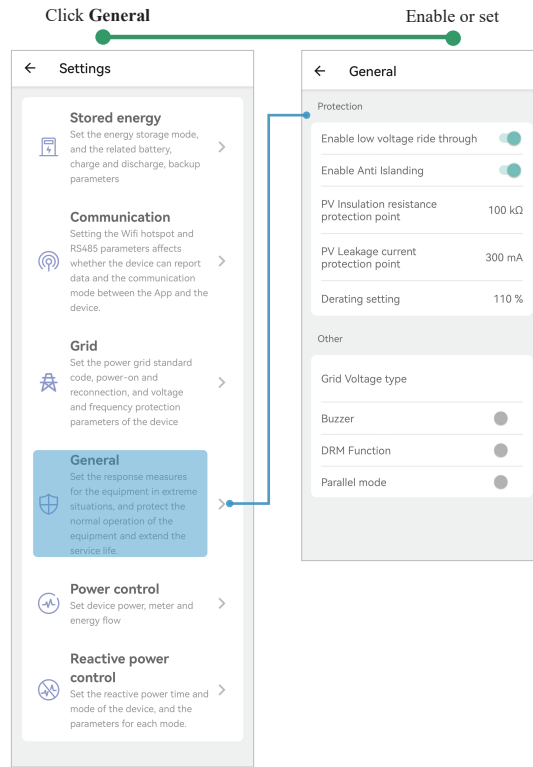

## 3.6 Power control

Set the power control parameters .

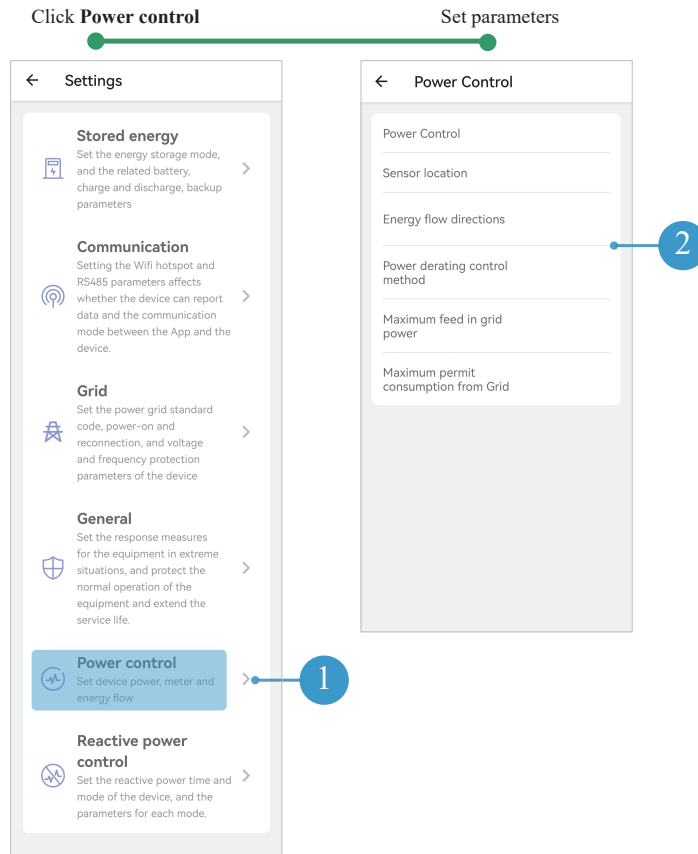

## 3.7 Reactive power control

Set the reactive power time and mode of the device, and the parameters for each mode.

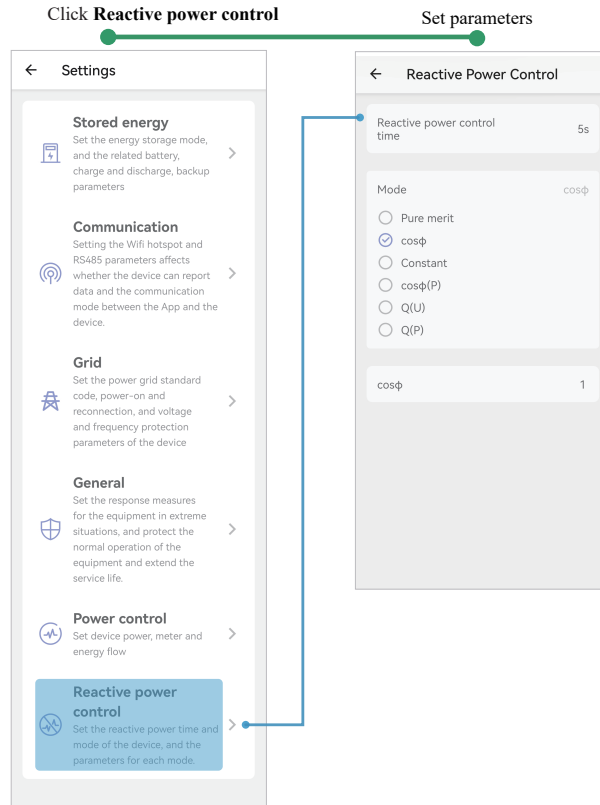

## 3.8 Equipment maintenance

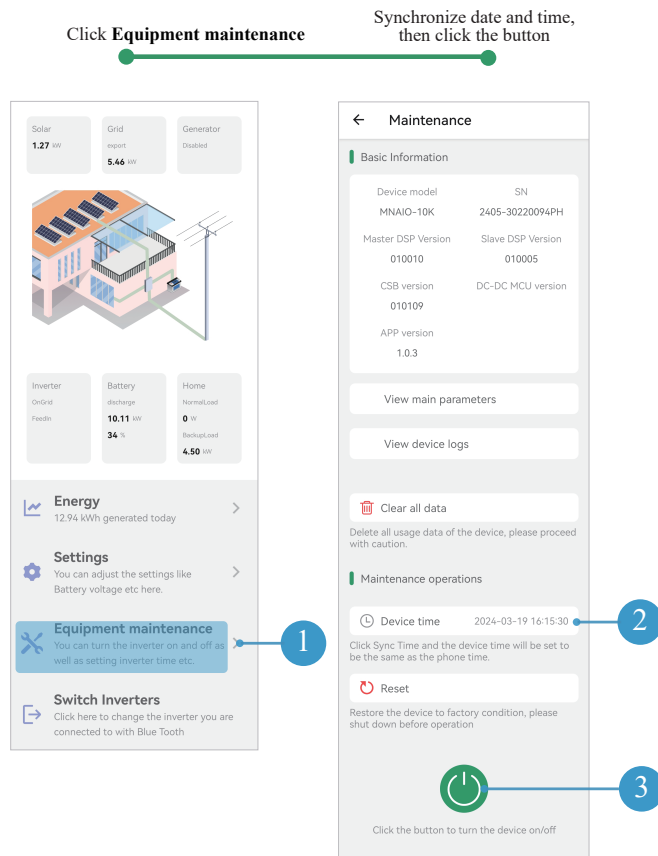



## 3.9 Programming Guide

The next diagram shows the most used/common parameters for programming the MIDNITE MN 15-12KW-AIO.

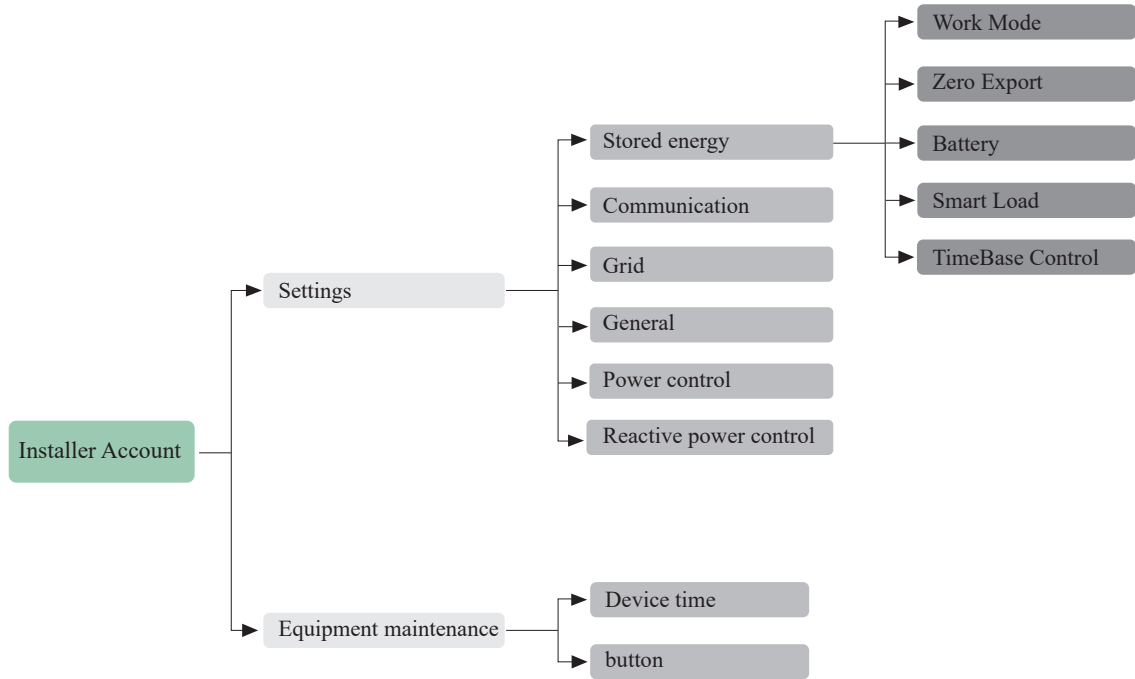

# 4. User Interface

## Download App for Local Setting

- Scan the QR code to download the App MidNite Pro.



- Download the APP from the App Store or Google Play

## Access Permission

Before using the local setting, the APP should access some permissions. (You can allow them when you install the APP or grant permissions in your own phone setting.) When the APP asks for permission, please click Allow.

## Connect Inverter and User Login

Firstly, open the bluetooth and the APP on your phone. Then connect the inverter and select end user to log in.

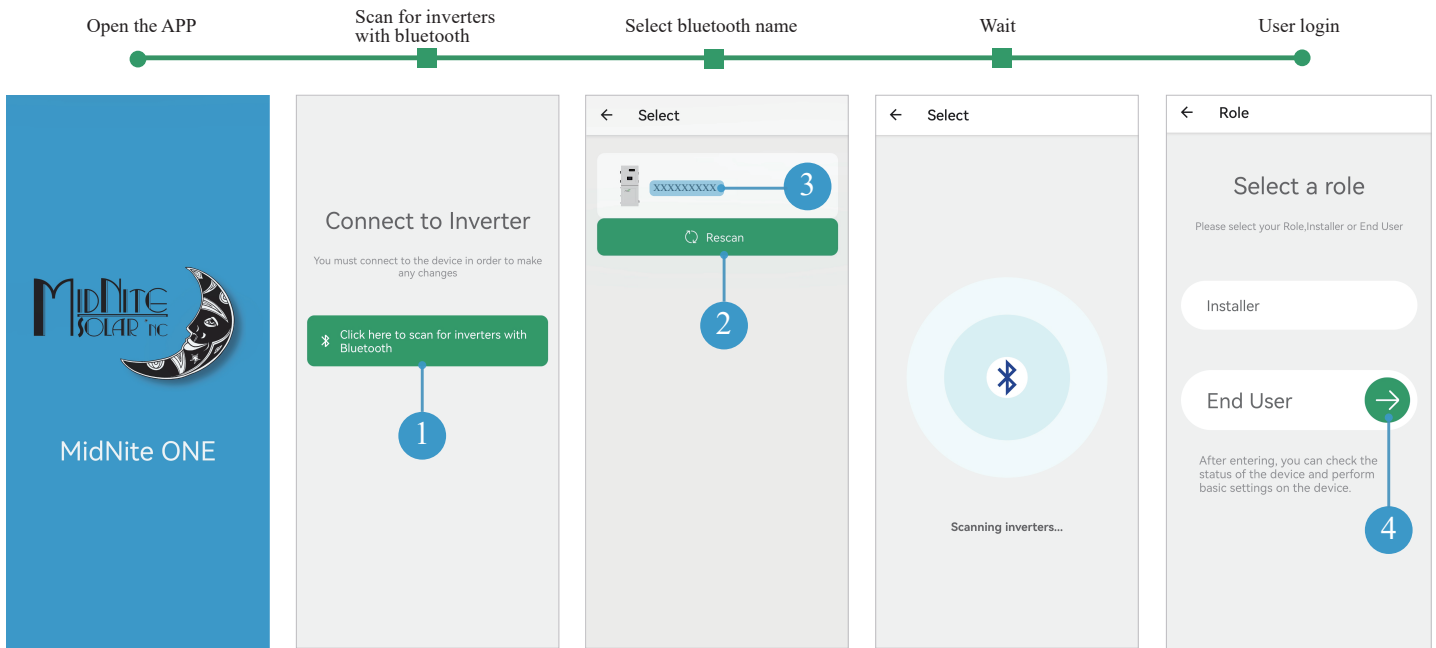

# 4.1 Home

In this page, you can view the basic information of inverter.

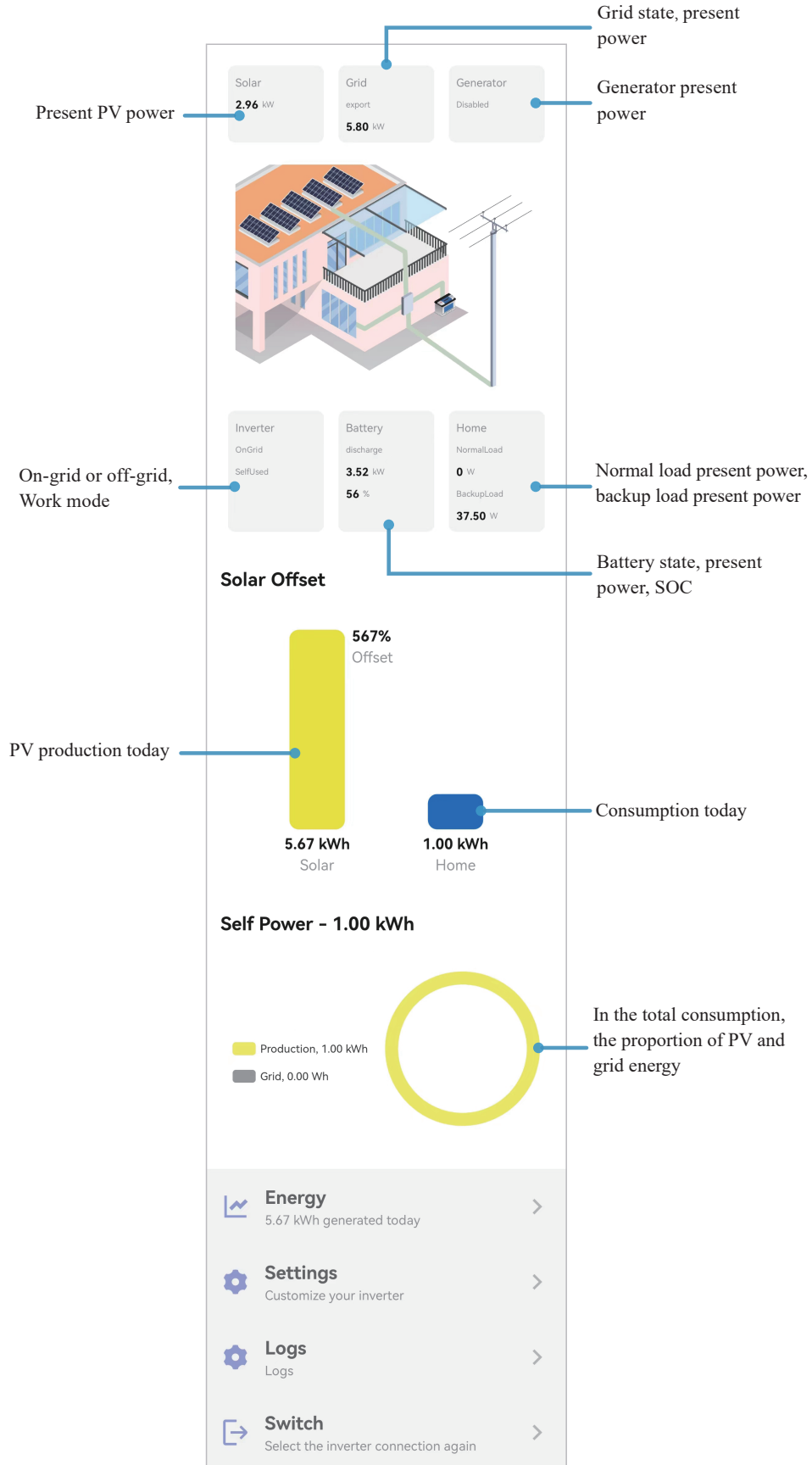

## 4.2 Energy

Click **Energy** at the bottom to view the curve graph of home, solar, battery, and grid production or consumption over a time period(day, month, year) .Data curves in the following figures are only for illustration. You can click anywhere on the graph to see the energy value of any time.

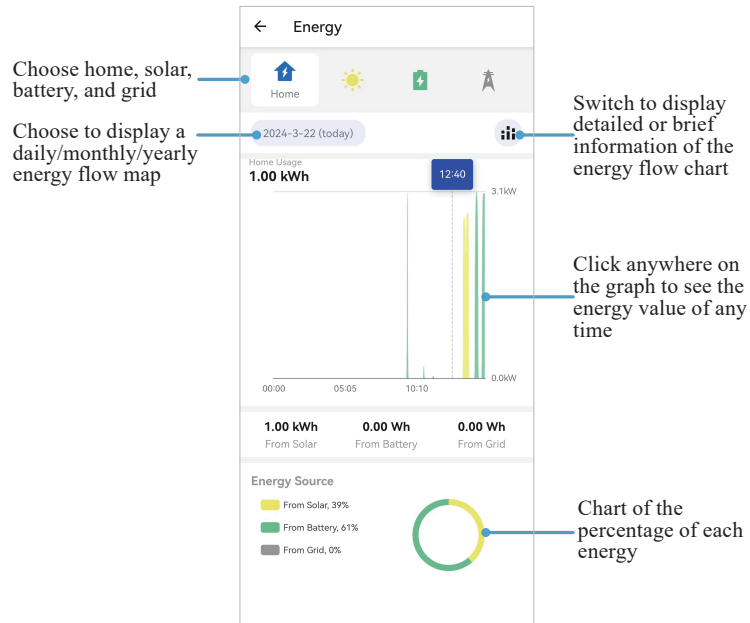

## 4.3 Settings

Click **Settings** at the bottom to set contents about Backup Reserve, Grid Charging and Battery Schedule.

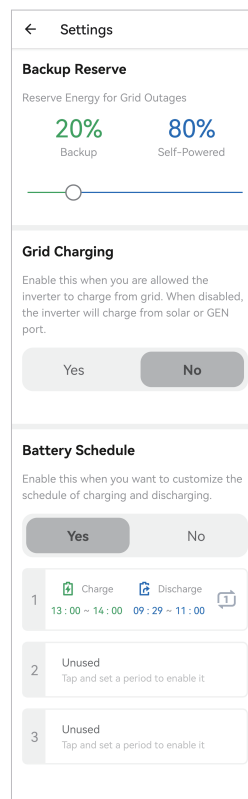

## 4.4 Logs

Click **Log** at the bottom and then go to the history log page (as shown below). It contains all the logs for the inverter.

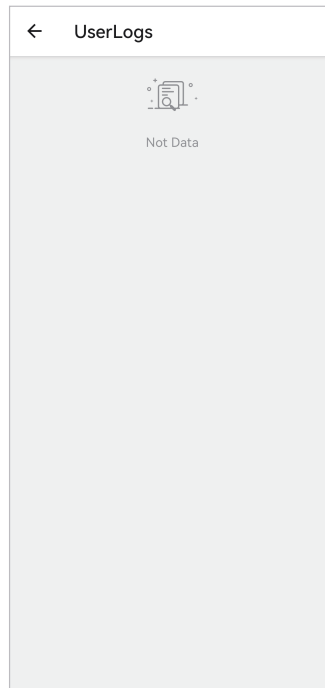

## 4.5 Switch

Click **Switch** at the bottom and then switch other inverters.

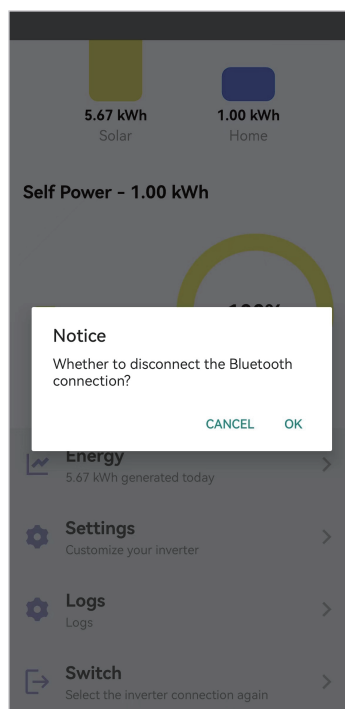

# 5. Parallel Systems

## 5.1 Before Enabling Parallel Operations

A. BMS communication connection is only for lithium battery.

- For shared lithium battery connection, please refer to Three-phase equipment connection diagram to connect the BMS communication cable.
- For standalone lithium battery connection, the BMS communication cable needs to be connected to each inverter.

B. It is necessary to additionally purchase suitable CT and meter according to the specific requirements in parallel connection. Meter+CT Ratio is 3000:1(optional).

C. It is necessary to turn the matched resistance switch of No. 1 inverter and No. N inverter to “ON” in parallel connection mode.

D. With parallel connection mode, it is necessary to connect APP to one of the inverters and then go to **Settings > General** to enable parallel mode.

E. The internal DC/AC breakers are supplied with the inverter.

- DC Breaker (Battery side): 300A/80VDC
- AC Breaker (GEN Input): 60A/120/240VAC
- AC Breaker (Smart loads): 30A/120/240VAC
- AC Breaker (AC Coupling): 50A/120/240VAC
- AC Breaker (AC Input grid/AC out): 100A/120/240VAC
- AC Breaker (Load 1 L2/Load 2 L2/Load 3 L1): 15A/120VAC
- AC Breaker (Load 4 L1): 20A/120VAC

 Ensure that the inverter and all cables to be installed have been completely powered off during the whole process of installation and connection. Otherwise, fatal injury could be caused by the high voltage.

### DIP Switch Configuration for Parallel Systems

In parallel systems, set the “DIP Switches” shown in the following, according to the table below.

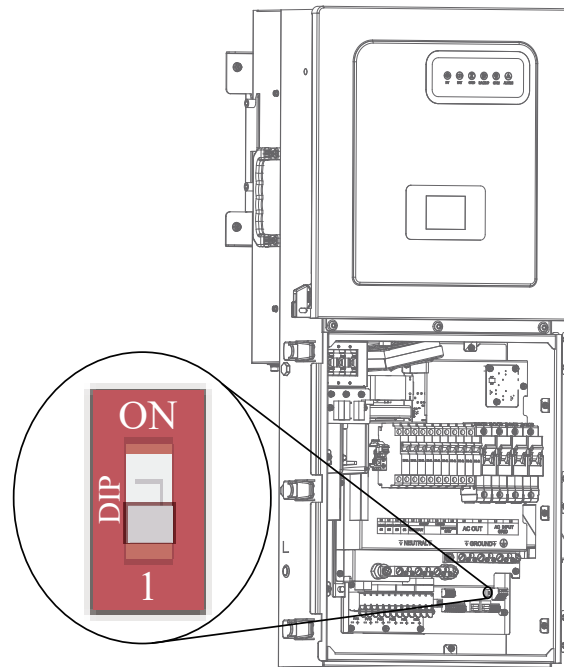

Inverter 1	Inverter 2	Inverter 3	Inverter 4	Inverter 5	Inverter 6	Inverter 7	Inverter 8	Inverter 9
1								
ON	ON							
ON	1	ON						
ON	1	1	ON					
ON	1	1	1	ON				
ON	1	1	1	1	ON			
ON	1	1	1	1	1	ON		
ON	1	1	1	1	1	1	ON	
ON	1	1	1	1	1	1	1	ON



Parallel systems with 2 inverters must have their DIP switches on the ON position.

## Parallel Systems MIDNITE MN 15-12KW-AIO @ 120/240V Split-Phase

# of inverters in parallel	Continuous output power with PV (kW)	Continuous output power with batteries (kW)	Grid "Pass Through" (A)	Peak power 10 sec (kVA)
1	15	10	100	15
2	30	20	200	30
3	45	30	300	45
4	60	40	400	60
5	75	50	500	75
6	90	60	600	90
7	105	70	700	105
8	120	80	800	120
9	135	90	900	135

## Parallel Systems MIDNITE MN 15-12KW-AIO @ 120/208V 3-Phase

# of inverters in parallel	Continuous output power with PV (kW)	Continuous output power with batteries (kW)	Grid "Pass Through" (A)	Peak power 10 sec (kVA)
1 (only 2 phases)	13	12	200	15
2 (all phases but unbalanced)	26	24	400	30
3	39	36	400	45

Make sure all inverters in parallel have the same firmware version by verifying the 'DSP', 'CSB', and 'DC-DC converter' version numbers on App, as shown in Figure a. It is recommended to restore the firmware before three-phase connection to ensure the same parameter for each inverter, as shown in Figure b.

- Verify version number: Click the **Equipment maintenance**.
- Restore the firmware: Click the **Equipment maintenance > Reset**.

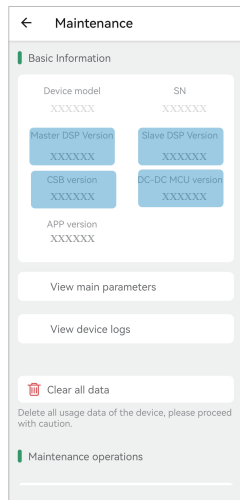

Figure a Verify version number

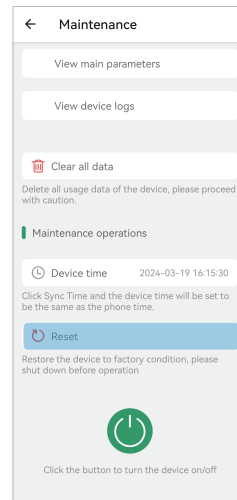

Figure b Restore the firmware

## 5.2 Parallel Systems Programming Sequence

### Parallel Systems MIDNITE MN 15-12KW-AIO @ 120/240V Split-Phase

Under split phase parallel connection mode, it is necessary to connect the APP to each inverter and set related parameters by following the steps below.

1. Installer login.
2. Go to **Settings > General** to enable parallel mode.

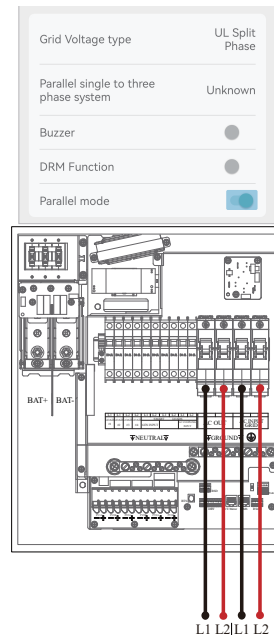
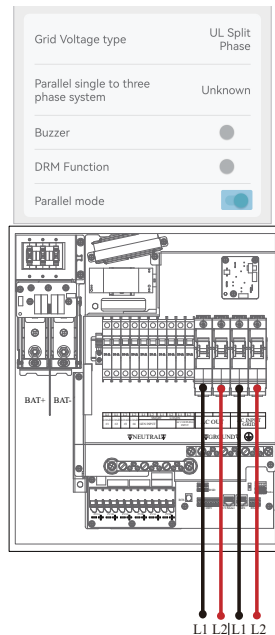



# Parallel Systems MIDNITE MN 15-12KW-AIO @ 120/208V 3-Phase

Under three-phase connection mode, it is necessary to connect the APP to each inverter and set related parameters by following the steps below.

1. Installer login.
2. Go to **Settings > General** to enable parallel mode, and set the phase position accordingly, as shown in Figure a-c. Notice that all three inverters should be set in this step.
3. Set the grid voltage type: Go to **Settings > General > Three Phase L-N voltage > Save**. (Figure d)
4. Set power control: Go to **Settings > Power Control > smart meter > Save**. (Figure e)
5. Set power derating control method: Go to **Settings > Power Control > Power derating control method > Independent phase power > Save**. (Figure f)
6. Set the other basic parameters of the inverter. Detailed setting process please refer to Chapter App Setting Guide.

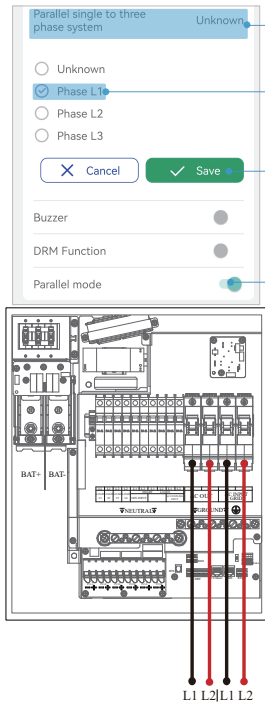

Figure a Inverter N1-Phase L1

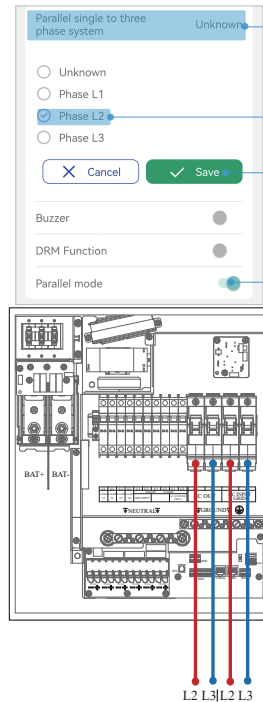

Figure b Inverter N2-Phase L2

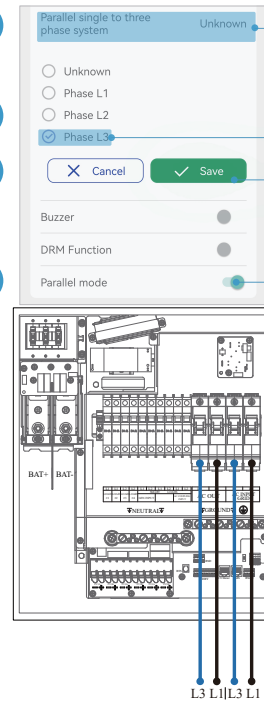

Figure c Inverter N3-Phase L3

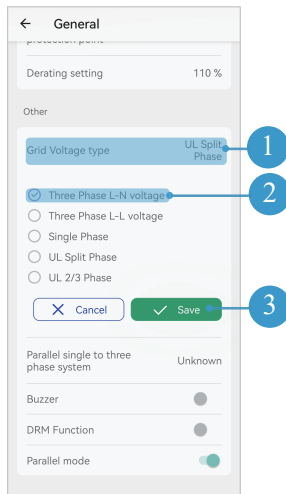

Figure d Grid Voltage Type

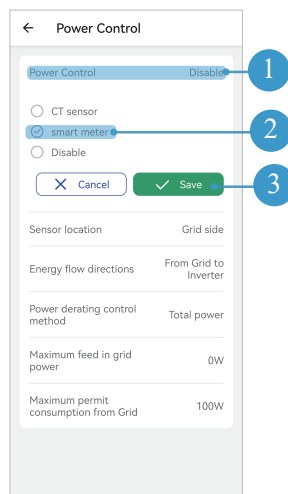

Figure e Power control

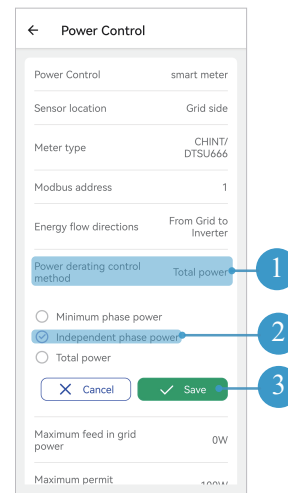
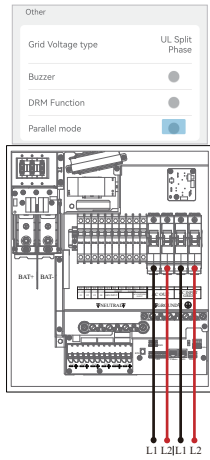

Figure f Power derating control method

# Examples of Wiring Diagram

1 inverter @ 120/240V  
Using 2 phases of 3



2 inverter @ 120/240V  
Using 2 phases of 3

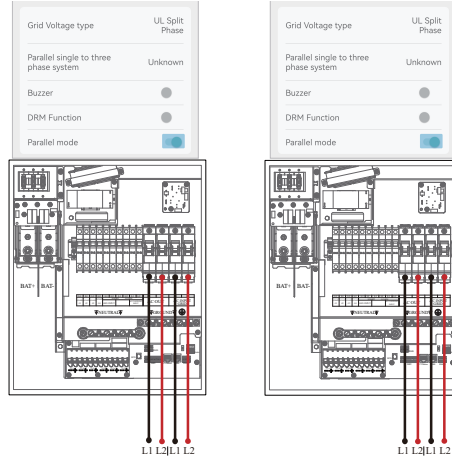

2 inverters @ 120/208V  
using 3 phases of 3 (Unbalanced)

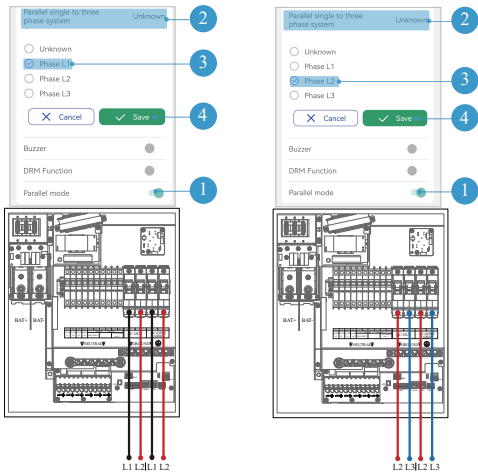

3 inverters @ 120/208V  
using 3 phases of 3 (Balanced)

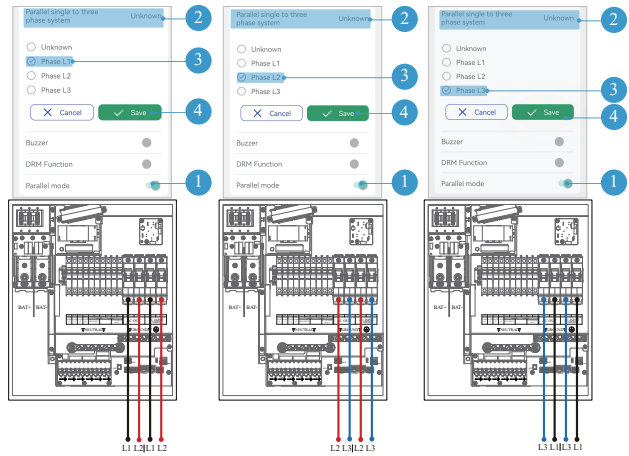

## 5.3 Three-Phase Systems: Programming and Troubleshooting

3-phase systems with multiple MIDNITE inverters must be programmed according to the table below:

# of inverters	Programming
2	Phase L1 01   Phase L2 02
3	Phase L1 01   Phase L2 02   Phase L3 03

### Examples of Wiring Diagram

**!** If the history log page of your App shows the error shown below, ensure the phase sequence follows L1L2-L2L3-L3L1 convention. The message “Phase Sequence abnormal” is displayed when the inverter does not detect the correct phase rotation. This situation can cause overloads faults in the system even with the “AC OUT” disconnected and **WILL CAUSE DAMAGE** to the equipment if it is not corrected.

	Terminal: L1	Terminal: L2
Inverter N1	Phase: L1	Phase: L2
Inverter N2	Phase: L2	Phase: L3
Inverter N3	Phase: L3	Phase: L1

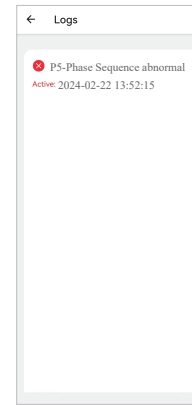

How to find an incorrect phase if prompted “Phase Sequence abnormal”?

- Measure L1 AC INPUT GRID of inverter N1 to L2 AC INPUT GRID of inverter N3. Should be 0Vac.
- Measure L2 AC INPUT GRID of inverter N1 to L1 AC INPUT GRID of inverter N2. Should be 0Vac.
- Measure L2 AC INPUT GRID of inverter N2 to L1 AC INPUT GRID of inverter N3. Should be 0Vac.
- Same process should be done for LOAD side.
- Measuring voltage different than 0Vac means the measured lines are not the same phase.
- **The MN 15-12KW-AIO can only receive direct rotation (clockwise).**

Be sure to check both, AC INPUT GRID and AC OUT terminal connections; both must be correct. If the error persists you will need to check your AC connection beyond the inverter and you will need to verify that the phases are correctly labeled from your meter.

*\* In 3 phase systems it is recommended to use a rotational tester (1-2-3, A-B-C).*

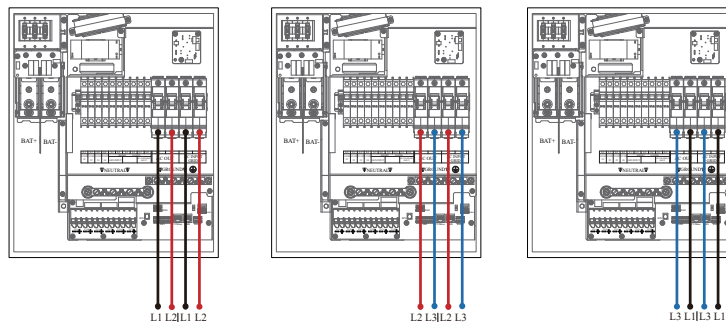

# 6. Wiring Diagrams



These wiring diagrams are examples of common use-cases for MIDNITE inverters. Diagrams must meet local electrical code and authorized jurisdiction requirements.

MIDNITE MN 15-12KW-AIO  
Standard Wiring Diagram

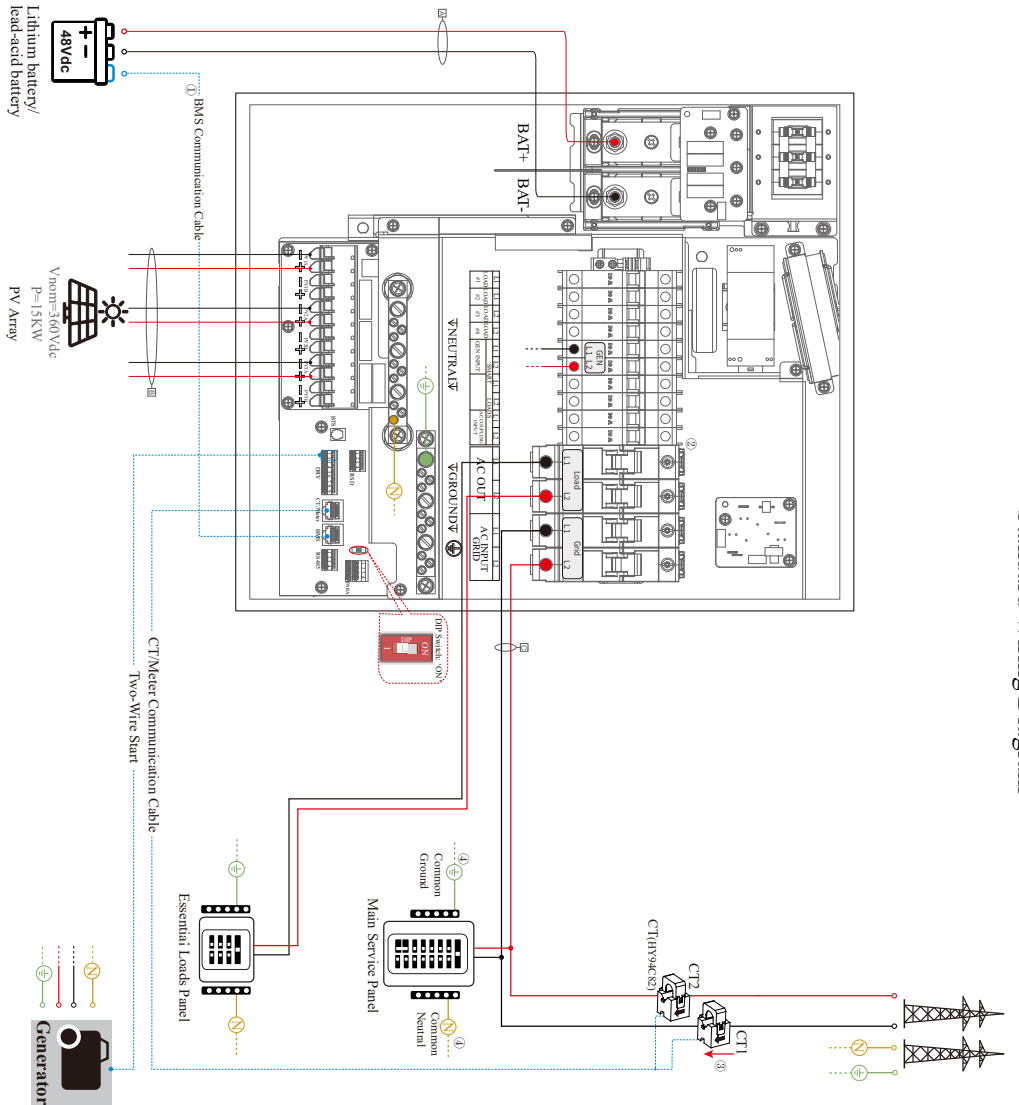

- ① BMS is only for lithium battery. When applying standard lithium battery connection, each inverter should be connected to BMS COM cable.
- ② The DC/AC breakers specification please refer to 2.3.3.1.1.1.
- ③ The DC/AC breakers current to 6.3kA from the grid disconnector.
- ④ ⚠ These symbols represent a common standard ground connection.

- (AC) L1
- (DC) BAT -
- (AC) L2
- (DC) BAT +
- NEUTRAL
- GROUND
- ..... COM

TABLE 1 BREAKER SPECIFICATION		TABLE 2 WIRE GAUGE GUIDE (COPPER)	
LOCATION	SPECIFICATION	LABEL	CONDUCTOR
Battery side(DC)	300A/80VDC	A	4/0 AWG
GEN side(AC)	60A/120/240VAC	B	8 AWG
Smart loads	30A/120/240VAC	C	2 AWG
AC Coupling	50A/120/240VAC		
AC In Grid/AC out	100A/120/240VAC		
Load 1 L1/Load 2 L2/Load 3 L1	15A/120VAC		
Load 4 L1	20A/120VAC		
Normal load side(AC)	Depend on required panel through customer and local code requirements.		

Diagram 01

# MIDNITE MN 15-12KW-A10 Standard Wiring Diagram - 2<N≤5 Parallel Inverters | 120/240V

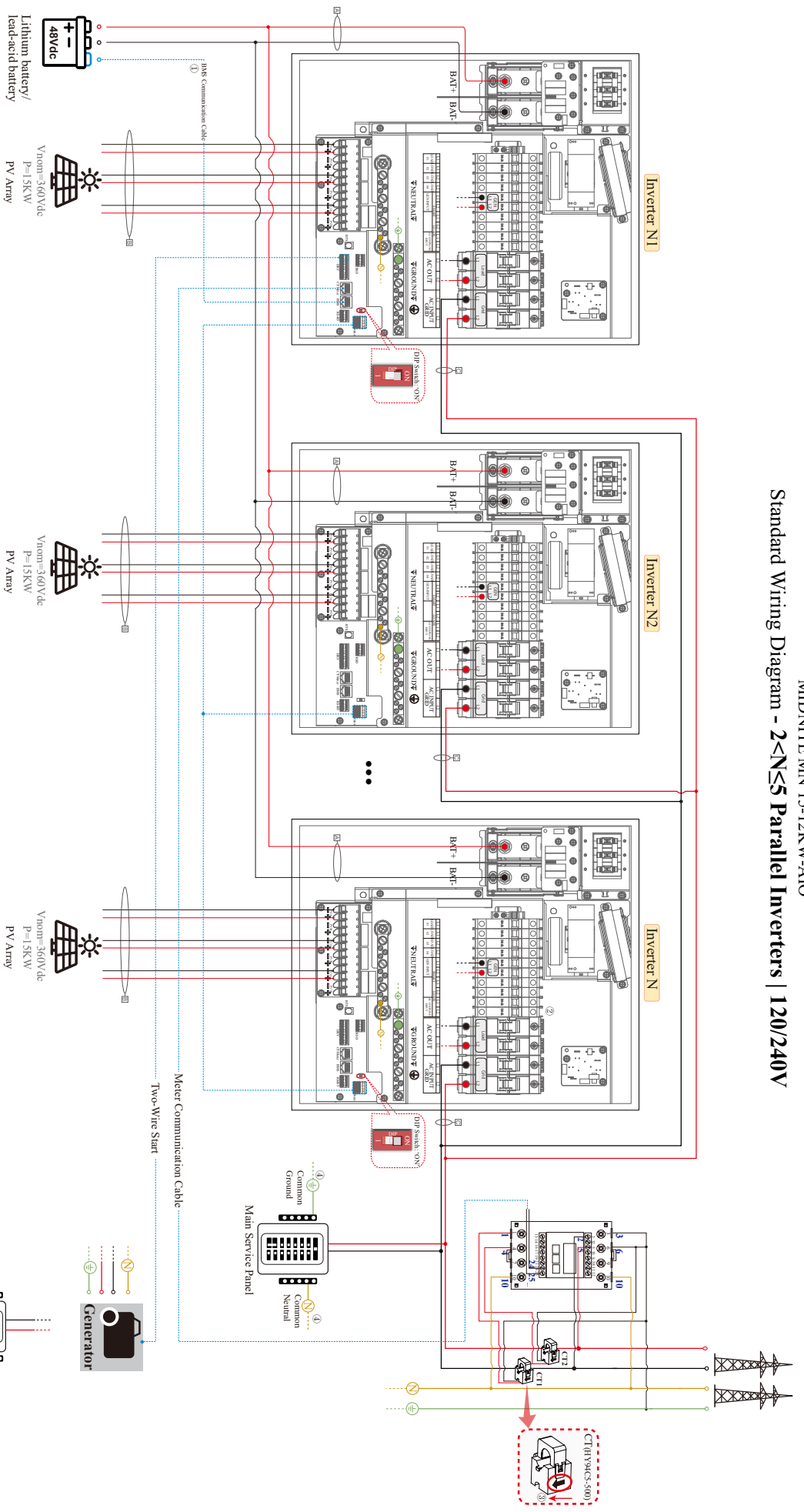
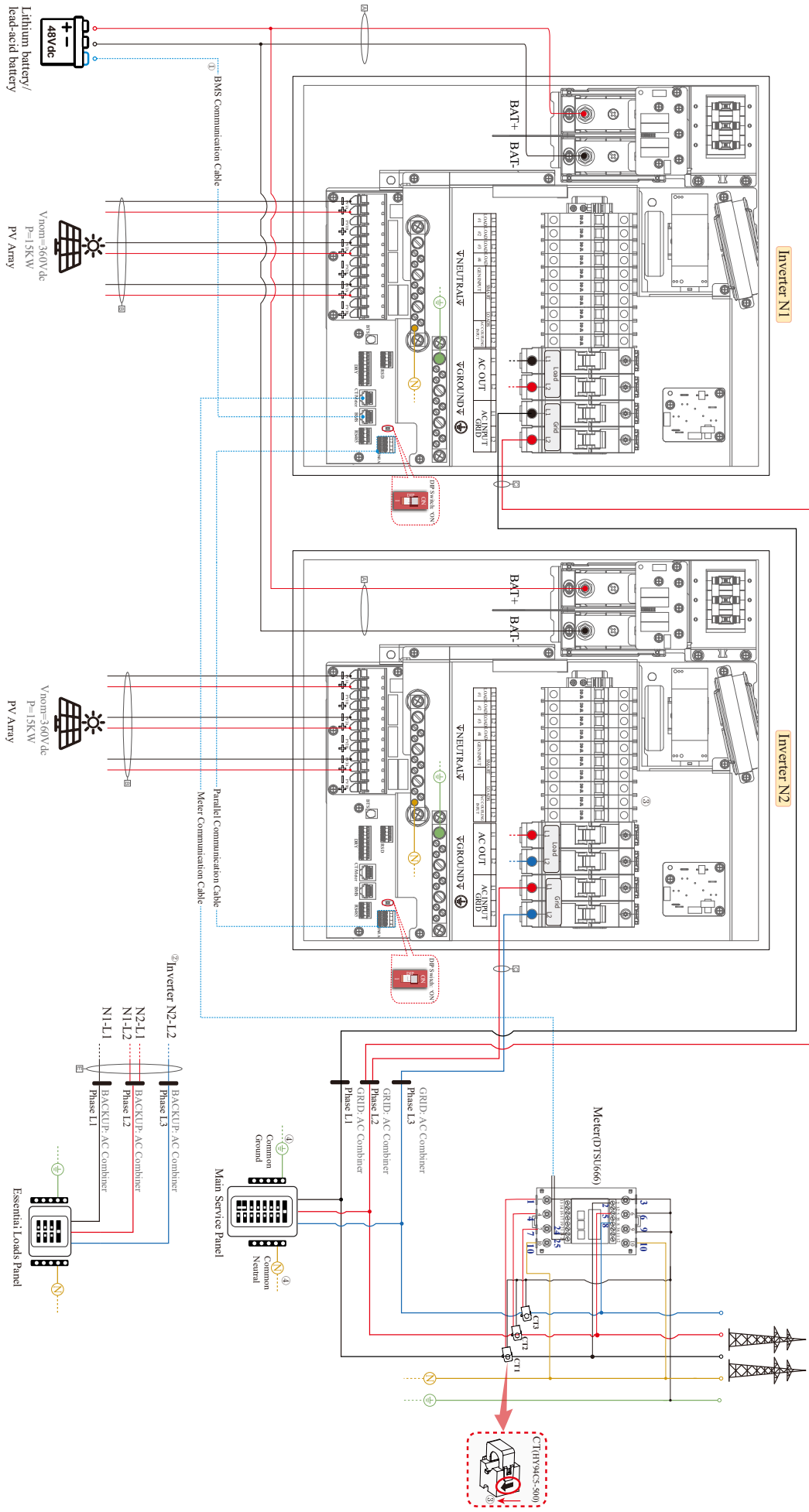

Diagram 02

# MIDNITE MN 15-12KW-A10 Standard Wiring Diagram - 2 Parallel Inverters | 120/208V



- ① BMS is only for lithium battery. When applying standalone lithium battery connection, each inverter should be connected to BMS COM cable.
- ② The wiring method of GEN/critical load is the same as that of the grid.
- ③ In 'N1-L1', 'N' represents inverter serial number; 'L' represents the phase of the wire in GRID/GEN/BACKUP connection.
- ④ The DC/AC breakers specification please refer to TABLE 1.
- ⑤ The arrow indicates the current in CT flows from the grid to the inverter.
- ⑥ These symbols represent a common neutral/ground connection.

- (AO) L1 (DC) PV+ (DC) BAT+
- (AO) L2 (DC) PV+ (DC) BAT+
- NEUTRAL
- GROUND
- COM

TABLE 1  
BREAKER SPECIFICATION

LOCATION	SPECIFICATION
Battery side(DC)	300A/80VDC
GEN side(AC)	60A/120/240VAC
Smart loads	30A/120/240VAC
AC Coupling	50A/120/240VAC
AC In Grid/AC out	100A/120/240VAC
Load 1 L2/Load 2 L2/Load 3 L1	15A/120VAC
Load 4 L1	20A/120VAC
Normal load side(AC)	20A/120VAC

TABLE 2  
WIRE GAUGE GUIDE (COPPER)

LABEL	CONDUCTOR
A	4/0 AWG
B	8 AWG
C	2 AWG

# MIDNITE MN 15-12KW-AIO Standard Wiring Diagram – 3 Parallel Inverters | 120/208V

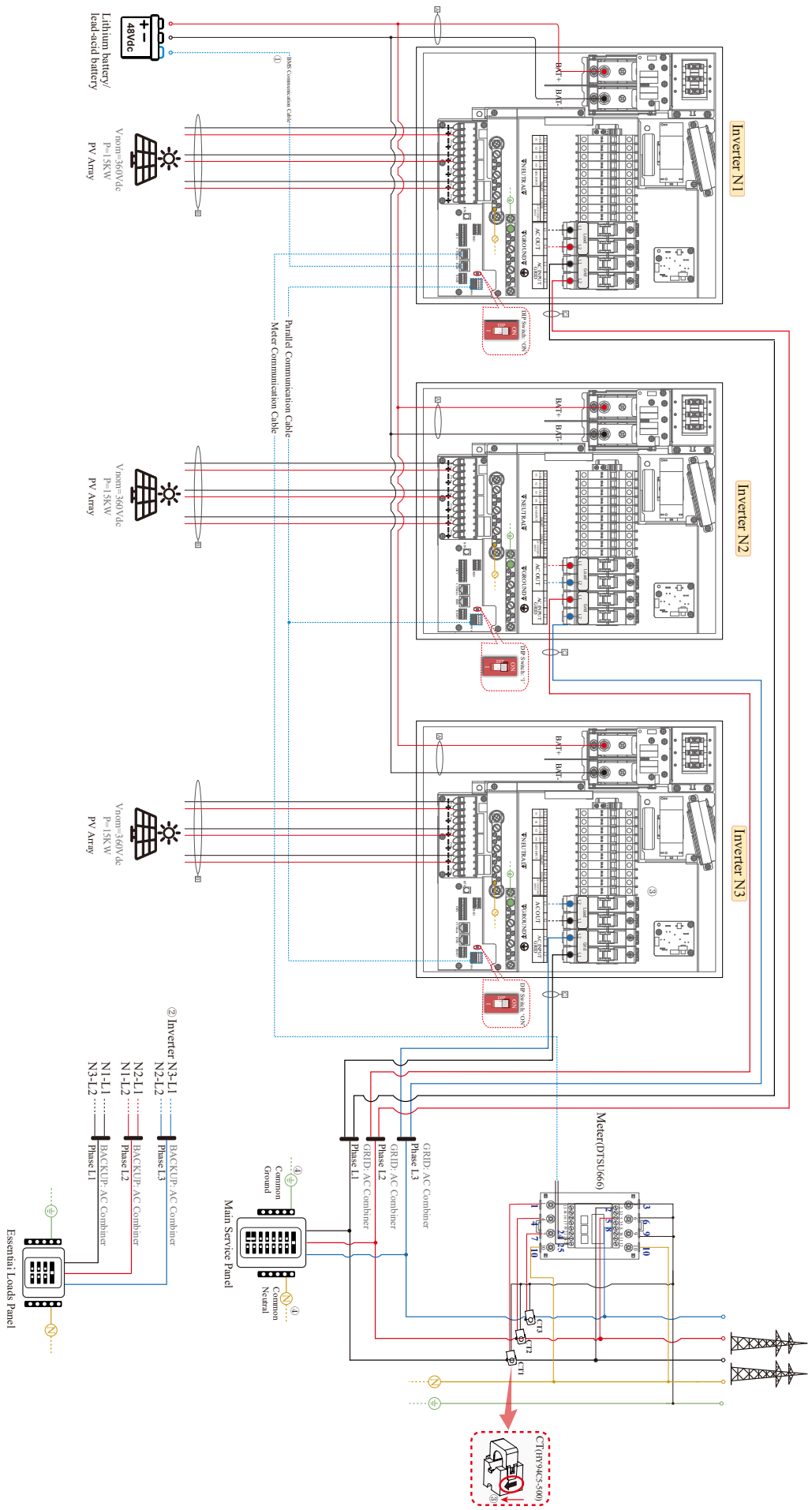

- ① RMS is only for lithium battery. When applying standard lithium battery connection, each inverter should be connected to BMS COM cable.
- ② The specification of the battery is based on the standard specification of the battery.
- ③ In 'NLS.L', 'N' represents inverter serial number; 'L' represents the phase of live wire in GRID/GEN/BACKUP connection.
- ④ The DC/AC breakers specification please refer to TABLE1.
- ⑤ The arrow indicates the current in CT flows from the grid to the inverter.
- ⑥ Ⓢ These symbols represent a common neutral/ground connection.

TABLE 1  
BREAKER SPECIFICATION

LOCATION	SPECIFICATION
Battery side(DC)	300A/80VDC
GEN side(AC)	60A/120/240VAC
Smart loads	30A/120/240VAC
AC Coupling	50A/120/240VAC
AC in Grid/AC out	100A/120/240VAC
Load 1 L2/Load 2 L2/Load 3 L1	15A/120VAC
Load 4 L1	20A/120VAC
Normal load side(AC)	20A/120VAC

TABLE 2  
WIRE GAUGE GUIDE (COPPER)

LABEL	CONDUCTOR
A	4/0 AWG
B	8 AWG
C	2 AWG

Diagram 04

# 7. Troubleshooting Guide

## 7.1 MIDNITE Error codes

FAULT	INSTRUCTION	COMMON CAUSE / REMEDY
A0	Grid over voltage	<ol style="list-style-type: none"> <li>1. If the alarm occurs occasionally, possibly the power grid voltage is abnormal temporarily, and no action is required.</li> <li>2. If the alarm occurs repeatedly, contact the local power station. After receiving approval of the local power bureau, revise the electrical protection parameter settings on the inverter through the App.</li> <li>3. If the alarm persists for a long time, check whether the AC circuit breaker /AC terminals is disconnected, or if the grid has a power outage.</li> </ol>
A1	Grid under voltage	
A3	Grid over frequency	
A4	Grid under frequency	
A2	Grid absent	Wait till power is restored.
B0	PV over voltage	Check whether the maximum input voltage of a single PV string exceeds the MPPT working voltage. If yes, modify the number of PV module connection strings.
B1	PV insulation abnormal	<ol style="list-style-type: none"> <li>1. Check the insulation resistance against the ground for the PV strings. If a short circuit has occurred, rectify the fault.</li> <li>2. If the insulation resistance against the ground is less than the default value in a rainy environment, set insulation resistance protection on the App.</li> </ol>
B2	Leakage current abnormal	<ol style="list-style-type: none"> <li>1. If the alarm occurs occasionally, the inverter can be automatically recovered to the normal operating status after the fault is rectified.</li> <li>2. If the alarm occurs repeatedly, contact your dealer for technical support.</li> </ol>
B4	PV under voltage	<ol style="list-style-type: none"> <li>1. If the alarm occurs occasionally, possibly the external circuits are abnormal accidentally. The inverter automatically recovers to the normal operating status after the fault is rectified.</li> <li>2. If the alarm occurs repeatedly or last a long time, check whether the insulation resistance against the ground of PV strings is too low.</li> </ol>
B7	PV string reverse	Check and modify the positive and negative polarity of the input of the circuit string.
C0	Internal power supply abnormal	<ol style="list-style-type: none"> <li>1. If the alarm occurs occasionally, the inverter can be automatically restored, and no action is required.</li> <li>2. If the alarm occurs repeatedly, please contact the customer service.</li> </ol>
C2	Inverter over dc-bias current	<ol style="list-style-type: none"> <li>1. If the alarm occurs occasionally, possibly the power grid voltage is abnormal temporarily, and no action is required.</li> <li>2. If the alarm occurs repeatedly, and the inverter fails to generate power, contact the customer service</li> </ol>



FAULT	INSTRUCTION	COMMON CAUSE / REMEDY
C3	Inverter relay abnormal	<ol style="list-style-type: none"> <li>1. If the alarm occurs occasionally, possibly the power grid voltage is abnormal temporarily, and no action is required.</li> <li>2. If the alarm occurs repeatedly, pls. refer to the suggestions or measures of Grid over voltage. If the inverter fails to generate power, contact the customer service center. If there is no abnormality on the grid side, the machine fault can be determined. (If you open the cover and find traces of damage to the relay, it can be concluded that the machine is faulty.) And pls. contact the customer service.</li> </ol>
CN	Remote off	<ol style="list-style-type: none"> <li>1. Local manual shutdown is performed in APP.</li> <li>2. The monitor executed the remote shutdown instruction.</li> <li>3. Remove the communication module and confirm whether the alarm disappears. If yes, replace the communication module. Otherwise, please contact the customer service.</li> </ol>
C5	Inverter over temperature	<ol style="list-style-type: none"> <li>1. If the alarm occurs occasionally, the inverter can be automatically recovered. No action is required.</li> <li>2. If the alarm occurs repeatedly, please check whether the installation site has direct sunlight, bad ventilation, or high ambient temperature (such as installed on the parapet). Yet, if the ambient temperature is lower than 45° C and the heat dissipation and ventilation is good, please contact customer service.</li> </ol>
C6	GFCI abnormal	<ol style="list-style-type: none"> <li>1. If the alarm occurs occasionally, it could have been an occasional exception to the external wiring. The inverter can be automatically recovered. No action is required.</li> <li>2. If it occurs repeatedly or cannot be recovered for a long time, please contact customer service.</li> </ol>
C8	Fan abnormal	<ol style="list-style-type: none"> <li>1. If the alarm occurs occasionally, pls. restart the inverter.</li> <li>2. If it occurs repeatedly or cannot be recovered for a long time, check whether the external fan is blocked by foreign objects. Otherwise, contact customer service.</li> </ol>
C9	Unbalance Dc-link voltage	Batteries exceeded their current discharge limit.
CA	Dc-link over voltage	<ol style="list-style-type: none"> <li>1. If the alarm occurs occasionally, the inverter can be automatically recovered and no action is required.</li> <li>2. If the alarm occurs repeatedly, the inverter cannot work properly. Pls. contact the customer service center.</li> </ol>
CB	Internal communication error	<ol style="list-style-type: none"> <li>1. If the alarm occurs occasionally, the inverter can be automatically recovered and no action is required.</li> <li>2. If the alarm occurs repeatedly, the inverter cannot work properly. Pls. contact the customer service center.</li> </ol>
CC	Software incompatibility	<ol style="list-style-type: none"> <li>1. If the alarm occurs occasionally, the inverter can be automatically recovered and no action is required.</li> <li>2. If the alarm occurs repeatedly, the inverter cannot work properly. Pls. contact the customer service center.</li> </ol>
CD	Internal storage error	<ol style="list-style-type: none"> <li>1. If the alarm occurs occasionally, the inverter can be automatically recovered and no action is required.</li> <li>2. If the alarm occurs repeatedly, the inverter cannot work properly. Pls. contact the customer service center.</li> </ol>

FAULT	INSTRUCTION	COMMON CAUSE / REMEDY
CE	Data inconsistency	<ol style="list-style-type: none"> <li>1. If the alarm occurs occasionally, the inverter can be automatically recovered and no action is required.</li> <li>2. If the alarm occurs repeatedly, the inverter cannot work properly. Pls. contact the customer service center.</li> </ol>
CF	Inverter abnormal	<ol style="list-style-type: none"> <li>1. If the alarm occurs occasionally, the inverter can be automatically recovered and no action is required.</li> <li>2. If the alarm occurs repeatedly, the inverter cannot work properly. Pls. contact the customer service center.</li> </ol>
CG	Boost abnormal	<ol style="list-style-type: none"> <li>1. If the alarm occurs occasionally, the inverter can be automatically recovered and no action is required.</li> <li>2. If the alarm occurs repeatedly, the inverter cannot work properly. Pls. contact the customer service center.</li> </ol>
CJ	Meter lost	<ol style="list-style-type: none"> <li>1. Check the meter parameter Settings</li> <li>2. Local APP checks that the communication address of the inverter is consistent with that of the electricity meter</li> <li>3. The communication line is connected incorrectly or in bad contact</li> <li>4. electricity meter failure.</li> <li>5. Exclude the above, if the alarm continues to occur, please contact the customer service center.</li> </ol>
P1	Parallel ID warning	It is Parallel ID Alarm. Pls. check the parallel communication cable, and check whether any inverter joins or exits online. All inverters are powered off completely, check the line, and then power on the inverters again to ensure that the alarm is cleared.
P2	Parallel SYN signal warning	Parallel synchronization signal is abnormal. Check whether the parallel communication cable is properly connected.
P3	Parallel BAT abnormal	The parallel battery is abnormal. Whether the battery of the inverter is reported low voltage or the battery is not connected.
P4	Parallel GRID abnormal	The parallel grid is abnormal. Whether the grid of the inverter is abnormal.
P5	Phase Sequence abnormal	<p>Ensure that the phase sequence of power grid is consistent with that of L1/L2/L3 on APP. To clear phase sequence abnormal alarm:</p> <p>Option 1: Power off all inverters, correct the phase sequence of each inverter and then restart the inverters.</p> <p>Option 2: Under inverter standby mode, correct the phase sequence of each inverter on APP, power off all inverters and then restart the inverters. If the alarm continues, please contact the customer service center.</p>
D2	Battery over voltage	<ol style="list-style-type: none"> <li>1. If the alarm occurs occasionally, the inverter can be automatically recovered and no action is required.</li> <li>2. Check that the battery overvoltage protection value is improperly set.</li> <li>3. The battery is abnormal.</li> <li>4. If exclude the above, the alarm continues to occur, please contact the customer service center.</li> </ol>

FAULT	INSTRUCTION	COMMON CAUSE / REMEDY
D3	Battery under voltage	<ol style="list-style-type: none"> <li>1. If the alarm occurs occasionally, the inverter can be automatically recovered and no action is required.</li> <li>2. Check the communication line connection between BMS and inverter (lithium battery).</li> <li>3. The battery is empty or the battery voltage is lower than the SOC cutoff voltage.</li> <li>4. The battery undervoltage protection value is improperly set.</li> <li>5. The battery is abnormal.</li> <li>6. If exclude the above, the alarm continues to occur, please contact the customer service center.</li> </ol>
D4	Battery discharger over current	<ol style="list-style-type: none"> <li>1. Check whether the battery parameters are correctly set.</li> <li>2. Battery undervoltage.</li> <li>3. Check whether a separate battery is loaded and the discharge current exceeds the battery specifications.</li> <li>4. The battery is abnormal.</li> <li>5. If exclude the above, the alarm continues to occur, please contact the customer service center.</li> </ol>
D5	Battery over temperature	<ol style="list-style-type: none"> <li>1. If the alarm occurs repeatedly, please check whether the installation site is in direct sunlight and whether the ambient temperature is too high (such as in a closed room).</li> </ol>
D6	Battery under temperature	<ol style="list-style-type: none"> <li>2. If the battery is abnormal, replace it with a new one.</li> <li>3. If exclude the above, the alarm continues to occur, please contact the customer service center.</li> </ol>
D7	BACKUP output voltage abnormal	<ol style="list-style-type: none"> <li>1. Check whether the AC OUTPUT voltage and frequency Settings are within the specified range.</li> <li>2. Check whether the AC OUTPUT circuit is overloaded.</li> <li>3. When not connected to the power grid, check whether AC OUTPUT voltage is normal.</li> <li>4. If exclude the above, the alarm continues to occur, please contact the customer service center.</li> </ol>
D8	Communication error (Inverter-BMS)	<ol style="list-style-type: none"> <li>1. Check whether the battery is disconnected.</li> <li>2. Check whether the battery is properly connected with the inverter.</li> <li>3. Confirm that the battery is compatible with the inverter. It is recommended to use CAN communication.</li> <li>4. Check whether the communication cable or port between the battery and the inverter is faulty.</li> <li>5. If exclude the above, the alarm continues to occur, please contact the customer service center.</li> </ol>
D9	Internal communication loss(E-M)	<ol style="list-style-type: none"> <li>1. Check whether the communication cables between AC OUTPUT, electricity meter and inverter are well connected and whether the wiring is correct (European units only).</li> </ol>
DA	Internal communication loss(M-D)	<ol style="list-style-type: none"> <li>2. Check whether the communication distance is within the specification range</li> <li>3. Disconnect the external communication and restart the electricity meter and inverter.</li> <li>4. If exclude the above, the alarm continues to occur, please contact the customer service center.</li> </ol>
CU	Dcdc abnormal	<ol style="list-style-type: none"> <li>1. If the alarm occurs occasionally, the inverter can be automatically recovered and no action is required.</li> <li>2. If the alarm occurs repeatedly, please check: <ol style="list-style-type: none"> <li>1) Check whether the MC4 terminal on the PV side is securely connected.</li> <li>2) Check whether the voltage at the PV side is open circuit, ground to ground, etc.</li> </ol> </li> <li>If exclude the above, the alarm continues to occur, please contact the customer service center.</li> </ol>

FAULT	INSTRUCTION	COMMON CAUSE / REMEDY
CP	BACKUP over dc-bias voltage	<ol style="list-style-type: none"> <li>1. If the alarm occurs occasionally, the inverter can be automatically recovered and no action is required.</li> <li>2. If the alarm occurs repeatedly, the inverter cannot work properly. Pls. contact the customer service center.</li> </ol>
DB	BACKUP short circuit	<ol style="list-style-type: none"> <li>1. Check whether the live line and neutral line of AC OUTPUT are short-circuited.</li> <li>2. If it is confirmed that the output is not short-circuited or an alarm, please contact customer service to report for repair. (After the troubleshooting of alarm problems, AC OUTPUT breaker needs to be manually turned on during normal use.)</li> </ol>
DC	BACKUP over load	<ol style="list-style-type: none"> <li>1. Disconnect the AC OUTPUT breaker and check whether the alarm is cleared.</li> <li>2. If the load is disconnected and the alarm is generated, please contact the customer service. (After the alarm is cleared, the AC OUT breaker needs to be manually turned on for normal use.)</li> </ol>

## NOTE

The *all in* **One**

---

*by MIDNITE SOLAR* 