

XR FLUSH MOUNT

UL 3741 PV HAZARD CONTROL INSTALLATION ADDENDUM

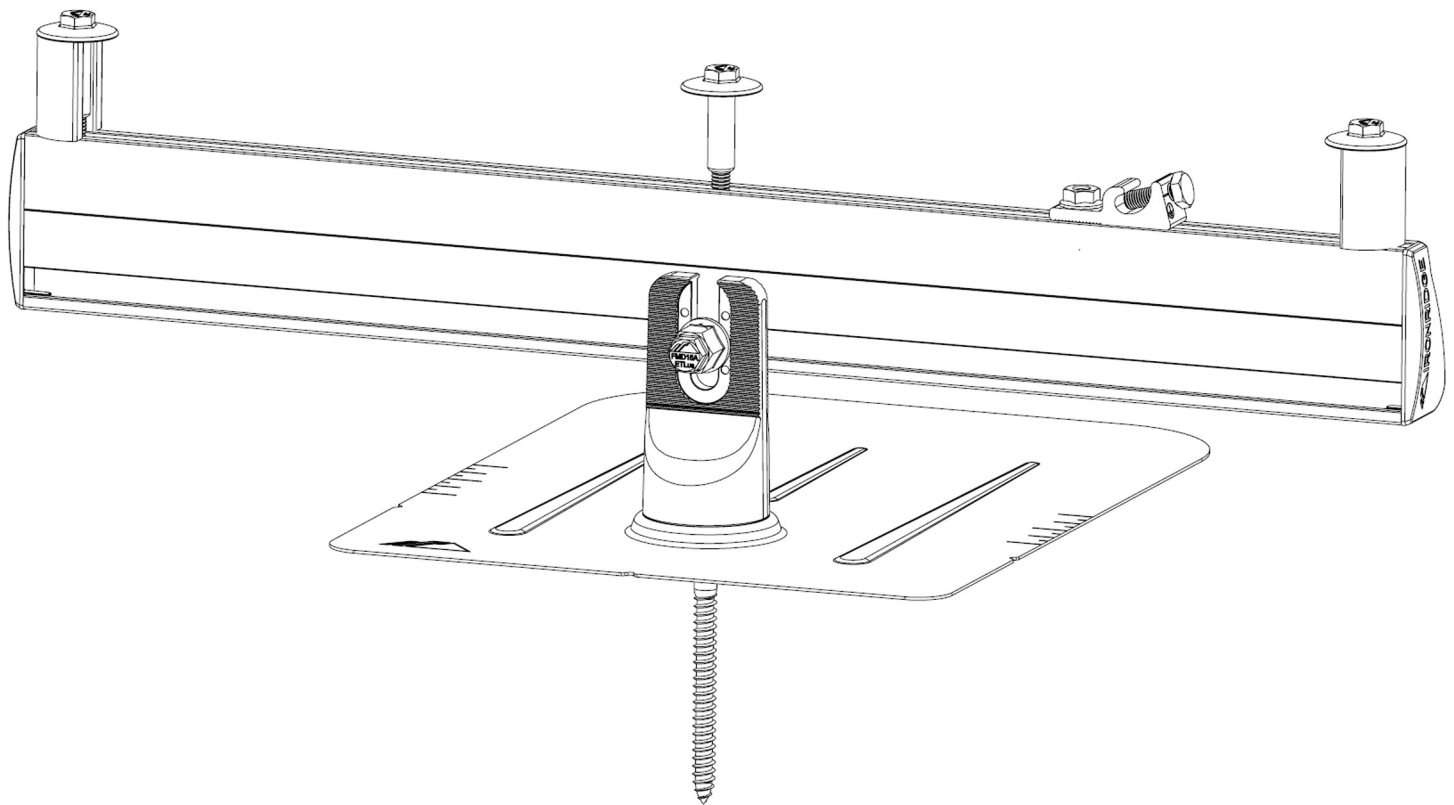

CONTENTS

DISCLAIMER	1
RATINGS	2
MARKINGS	2
UL 3741 LISTED PV HAZARD CONTROL ELECTRICAL EQUIPMENT	
TESLA	3
SOLIS	4
INTRODUCTION: UNDERSTANDING UL 3741 AND NEC 690.12	5
INSTALLATION METHODS PER UL 3741 AND NEC 690.12	5
CASE 1: UL 3741 LISTED SYSTEM, SINGLE ARRAY	6
CASE 2: UL 3741 LISTED SYSTEM, CONTIGUOUS SUB-ARRAY	7
CASE 3: UL 3741 LISTED SYSTEM, MULTIPLE ARRAYS	8
UL 3741 WIRE MANAGEMENT GUIDELINES	9
UL 3741 APPROVED MODULE LIST	10

DISCLAIMER

This manual describes proper installation procedures and provides necessary standards required for product reliability. Warranty details are available at [IronRidge.com](https://www.ironridge.com). All installers must thoroughly read this manual and have a clear understanding of the installation procedures prior to installation. Failure to follow these guidelines may result in property damage, bodily injury or even death.

IT IS THE INSTALLER'S RESPONSIBILITY TO:

- Ensure safe installation of all electrical aspects of the array. All electrical installation and procedures should be conducted by a licensed and bonded electrician or solar contractor. Routine maintenance of a module or panel shall not involve breaking or disturbing the bonding path of the system. All work must comply with national, state and local installation procedures, product and safety standards.
- Comply with all applicable local or national building and fire codes, including any that may supersede this manual.
- Ensure all products are appropriate for the installation, environment, and array under the site's loading conditions.
- Use only IronRidge parts or parts recommended by IronRidge; substituting parts may void any applicable warranty.
- Review the [Design Assistant](#) to confirm design specifications.
- Ensure provided information is accurate. Issues resulting from inaccurate information are the installer's responsibility.
- Ensure bare copper grounding wire does not contact aluminum and zinc-plated steel components, to prevent risk of galvanic corrosion.
- If loose components or loose fasteners are found during periodic inspection, re-tighten immediately. Any components showing signs of corrosion or damage that compromise safety shall be replaced immediately.
- Provide an appropriate method of direct-to-earth grounding according to the latest edition of the National Electrical Code, including NEC 250: Grounding and Bonding, and NEC 690: Solar Photovoltaic Systems.
- Disconnect AC power before servicing or removing modules, AC modules, microinverters and power optimizers.
- Review module manufacturer's documentation for compatibility and compliance with warranty terms and conditions. Installers shall refer to the XR Flush Mount System installation manual for complete installation instructions.
- Review all third party equipment installation manuals for specific instructions such as installation configurations, mounting, clearances, compatible connectors, and rapid shutdown initiation methods.
- Ensure that the roof is in good condition prior to installing any IronRidge components.

RATINGS

UL 3741 LISTED



CONFORMS TO ANSI/CAN/UL STD 3741 STANDARD FOR SAFETY PHOTOVOLTAIC HAZARD CONTROL SYSTEM

- Max PVHCS System Voltage: 1000V

LIST OF APPROVED PV HAZARD CONTROL EQUIPMENT OR COMPONENTS EVALUATED AT 1000V:

- **Flush Mount Attachments & Components**
 - Refer to IronRidge Flush Mount Installation Manual for installation methods and list of approved XR Flush Mount components and roof attachments for Composition Shingle, Metal, Tile and Low Slope Roofs.
 - Ground Lug (XR-LUG-03-A1, XR-LUG-04-A1, PV-LUG-01-A1, PV-LUG-02-A1)
- **Electrical Balance of System Components**
 - PV Connectors (UL 6703 Listed) shall be compatible and approved for the application
 - PV Wire (UL 4703 Listed)
 - XR Wire Clip (XR-WC-01-B1)
 - Edge Clip (BX-CT-EC-P1) and Cable Ties (BX-CT-UV-P1) (UL 62275 Listed)
 - Heyco Sunrunner Wire Clips (UL 1565 Listed)
 - EZ Solar Cable Loc (UL 62275 Listed)
 - PV Modules with Max Module size 30.5sqft (refer to page 9 for approved module list)
- **Listed Conduit**
 - Electrical Metallic Tubing (EMT) (UL 797 Listed)
 - Rigid Metal Conduit (RMC) (UL 6 Listed)
 - Intermediate Metal Conduit (IMC) (UL 1242 Listed)
 - Flexible Metal Conduit (UL 1 Listed)
 - Liquid Flexible Metal Conduit (UL 360 Listed)
 - Schedule 40/80 Rigid PVC Conduit (UL 651 Listed)
 - Listed Tubing, Fittings and Grounding Components
- **PV Hazard Control Equipment**
 - Tesla - Page 3
 - Solis - Page 4

NOTE: XR Flush Mount was evaluated up to 1000 Vdc. However, per NEC 690.7, PV system DC circuits on one- or two-family dwellings are limited to 600 Vdc maximum. PV system DC circuits on other types of buildings are limited to 1000 Vdc maximum. Requirements for PV arrays addressed in UL 3741 are intended for compliance with the National Electrical Code (NEC), NFPA 70, 2017 and later editions and their requirements for controlling electrical shock hazards inside the array boundary as addressed in NEC section 690.12(B)(2), Rapid Shutdown of PV Systems on Buildings and with the Canadian Electrical Code (CE Code) C22.1. The inverters and power conversion systems listed within this PVHCS install addendum additionally comply with the 30V in 30 seconds requirements outside the PV array as required in 690.12 (B)(1).

MARKINGS

Markings are located on the Grounding Lug bolt head.

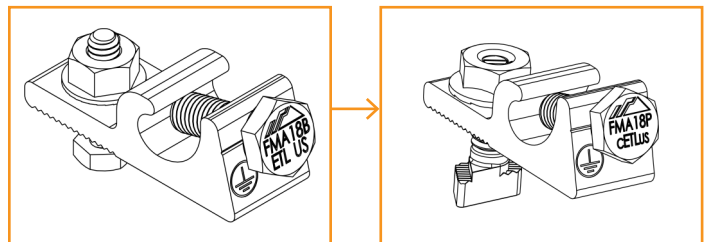

APPROVED TESLA ELECTRICAL EQUIPMENT WITH MAXIMUM SYSTEM VOLTAGE 600V:

String Isolation Devices (SID)	Power Conversion System (PCS)	
Tesla MCI-1 (1550379-00-F) Max Voltage = 600V, Max Imp = 13A, Max Isc = 19A	PV Inverter (PVI)	Energy Storage Systems (ESS)
	7.6 kW (1538000) 3.8 kW (1534000)	Powerwall+ (1850000) Powerwall 3 (1707000)

IMPORTANT: Refer to the applicable Tesla Inverter or Powerwall Installation Manual for specific instructions, including MCI-1 mounting, clearances, ratings, compatible connectors, and rapid shutdown initiation methods. MCI-1 installation configurations shown below are specific to the IronRidge XR Flush Mount UL 3741 Listing and supersede MCI-1 configurations shown in the [Tesla installation](#) manuals.

Contiguous Arrays

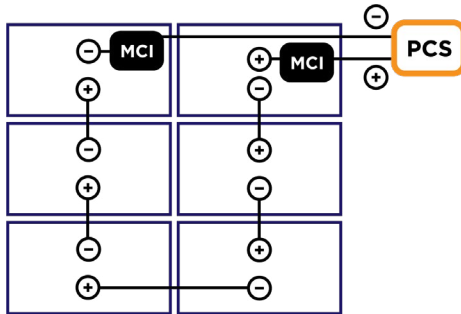

Where one or more PV strings are connected within a single contiguous array as shown in the figure, Tesla MCI-1s shall at a minimum be installed at both the positive and negative ends of each string between the last module and the homerun to the PCS. If there are multiple arrays each shall be equipped with MCI-1s as shown in the figure.

Non-Contiguous Arrays

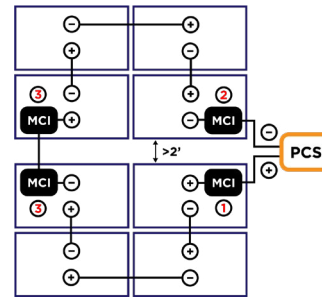

Where any string is connected across non-contiguous sub-arrays separated by more than 2' (see example figure), MCI-1s shall be installed as follows:

1. At the positive end of the string between the last module and the PCS homerun.
2. At the negative end of the string between the last module and the PCS homerun.
3. At both ends of the connection between sub-arrays.

NOTE: Use the XR MLPE Mounting Kit to mount the MCI-1 to the XR Rail. Refer to Flush Mount Installation Manual for further instructions.

APPROVED SOLIS ELECTRICAL EQUIPMENT WITH MAXIMUM SYSTEM VOLTAGE 600V:

String Isolation Device (SID)	Power Conversion System (PCS)
Midnite Solar MNSSR-600S-SS Max Voltage = 600V Max. Imp = 10A Max. Isc = 12A	PV Inverter (PVI) Solis 4G Grid-Tied Inverter with integrated APsmart PLC Transmitter*
	3.6 kW (Solis-1P3.6K-4G-US) 5 kW (Solis-1P5K-4G-US) 6 kW (Solis-1P6K-4G-US) 7.6 kW (Solis-1P7.6K-4G-US) 10 kW (Solis-1P10K-4G-US) *When ordering, add -APST to end of model name

IMPORTANT: Refer to the applicable [Solis](#) and Midnite Installation Manuals for specific instructions, including MNSSR mounting, clearances, ratings, compatible connectors, and rapid shutdown initiation methods.

SID Installation Instructions

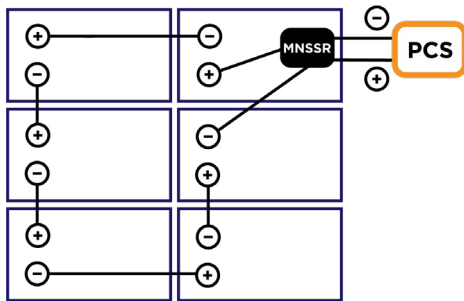

Where one or more PV strings are connected within a single contiguous array as shown in the figure, the positive and negative ends of each string shall be connected to the MNSSR. The output conductors of each MNSSR get connected to the PCS. If there are multiple arrays, then each array each shall be equipped with an MNSSR as shown in the figure.

NOTE: MNSSR products shall be mounted on the module frame. Refer to the Midnite Solar installation manual for further instructions.

2020/2023 NEC 690.12(B)(2) Controlling Conductors Within the Array Boundary

The XR Flush Mount Photovoltaic Hazard Control System (PVHCS) is a UL 3741 Listed system that complies with NEC 690.12(B)(2), when installed by qualified persons per the installation procedures outlined in the XR Flush Mount System Installation Manual and this Addendum. Please refer to the following pages of this addendum for various example cases of system designs that comply with 690.12(B)(2).

2020/2023 NEC 690.12 Background

NEC 690.12 Rapid Shutdown of PV Systems on Buildings requires that all PV arrays installed on or in buildings shall include rapid shutdown functions to reduce shock hazard for Fire Fighters (FF) in accordance with 690.12(A) through (D):

(A) Controlled Conductors

- (1) PV system DC circuits
- (2) Inverter output circuits originating from inverters located within array boundary

(B) Controlled Limits

- (1) Outside Array Boundary: $\leq 30V$ within 30 seconds
- (2) Inside Array Boundary - The PV System shall comply with one of the following:
 - (1) Listed PV Hazard Control System (UL 3741)
 - (2) $\leq 80V$ within 30 seconds after rapid shutdown initiation
 - (3) PV array without exposed wiring methods or conductive parts (NEC 2020 only)

(C) Initiation Devices

- Initiation device(s) shall initiate the rapid shutdown function of the PV system

(D) NEC 2020 - Equipment

- Equipment that performs the rapid shutdown functions, other than initiation devices such as listed disconnect switches, circuit breakers, or control switches, shall be listed for providing rapid shutdown protection.

(D) NEC 2023 - Building with Rapid Shutdown

- Buildings with PV systems shall have a permanent label located at each service equipment location to which the PV systems are connected or at an approved readily visible location and shall indicate the location of rapid shutdown initiation devices.

🔗 NEC 690.2 (2020) or Article 100 (2023) defines the array as a mechanically and electrically integrated grouping of modules with support structure, including any attached system components such as inverter (s) or dc-to-dc converter(s) and attached associated wiring.

🔗 NEC 690.12(B) defines the array boundary as 1ft from array in all directions. This indicates that the array boundary can extend 1 ft from the edge of the XR Flush Mount racking or module.

INSTALLATION METHODS PER UL 3741 AND NEC 690.12

The following case studies are provided by Ironridge to show examples of installation configurations that comply with NEC 690.12(B), however compliance is not limited to these examples.

Case 1: UL 3741 Listed System, Single Arrays – [Page 5](#)

Case 2: UL 3741 Listed System, Contiguous Sub-Array – [Page 6](#)

Case 3: UL 3741 Listed System, Multiple Arrays – [Page 7](#)

The simplest installation method to comply with NEC 690.12(B) is to utilize the XR Flush Mount UL 3741 system with a single array (Case 1). Installations where sub-arrays can be included within a 1-ft array boundary, or 2-ft total, can be considered a contiguous array (Case 2). With multiple arrays, and more than a 2-ft gap between them, see Case 3.

All inverter and/or energy storage input circuits (DC) outside of the PV array boundary will require the use of String Isolation Devices (SID) to de-energize circuits leaving the array per 690.12(B)(1) after initiation (DC disconnect, AC breaker or AC disconnect). Inverter and/or energy storage output circuits (AC) are outside of the array boundary and meet the 690.12(B)(1) requirement after initiation (AC breaker or AC disconnect).

Case studies and NEC guidance have not been verified by Intertek.

Single arrays comply with NEC 690.12(B)(2)(1)

- **Outside Array Boundary:** $\leq 30V$ within 30 Seconds
- **Inside Array Boundary:** $\leq 600V$ Residential, 1000V Commercial

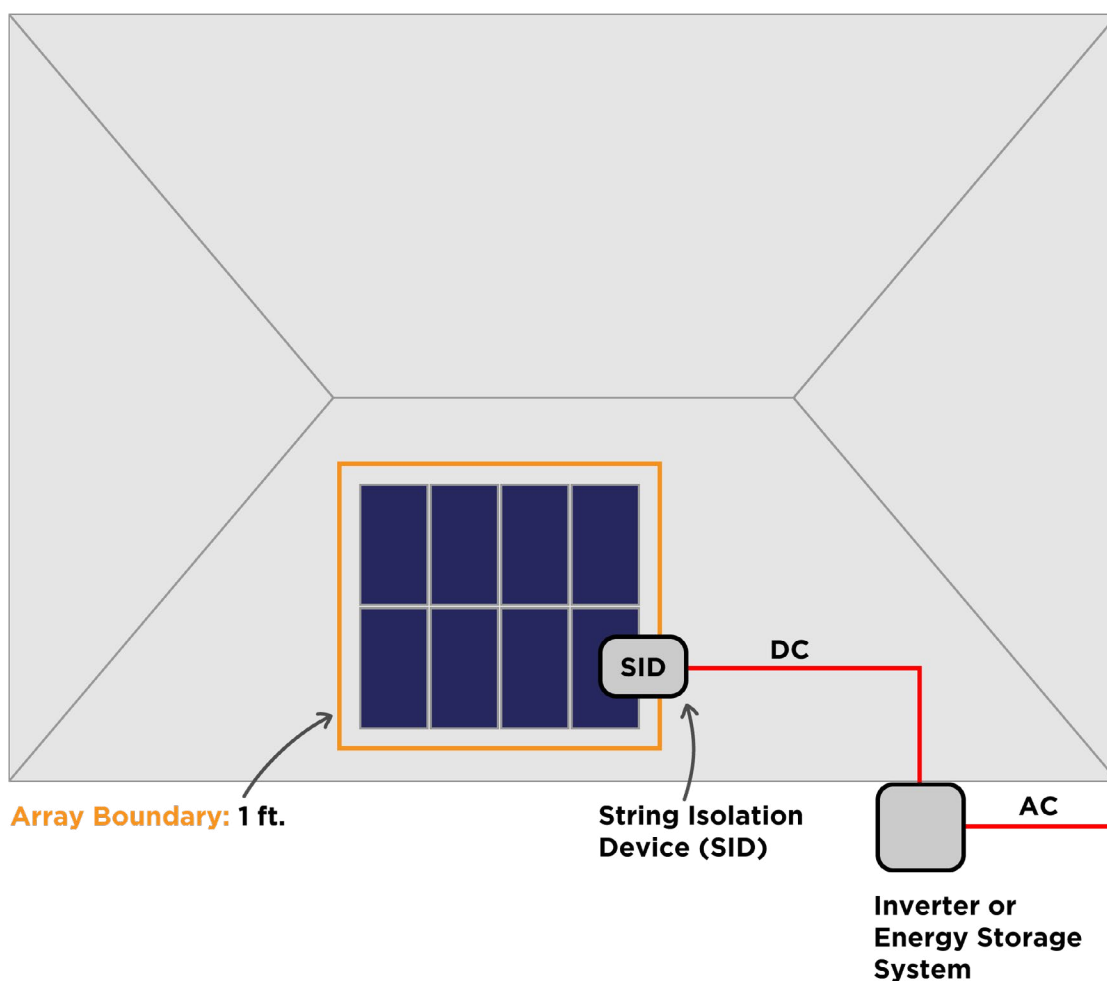

Case 1: Maintaining NEC compliance for single arrays.

Single arrays require the use of a SID as shown in the figure above to control the conductors outside of the array boundary.

IMPORTANT: Review electrical equipment page(s) for specific approved SID(s) and install methods.

Sub-array(s) within the same array boundary ($\leq 2\text{ft}$) are considered contiguous and comply with NEC 690.12(B)(2)(1)

- **Outside Array Boundary:** $\leq 30\text{V}$ within 30 Seconds
- **Inside Array Boundary:** $\leq 600\text{V}$ Residential, 1000V Commercial

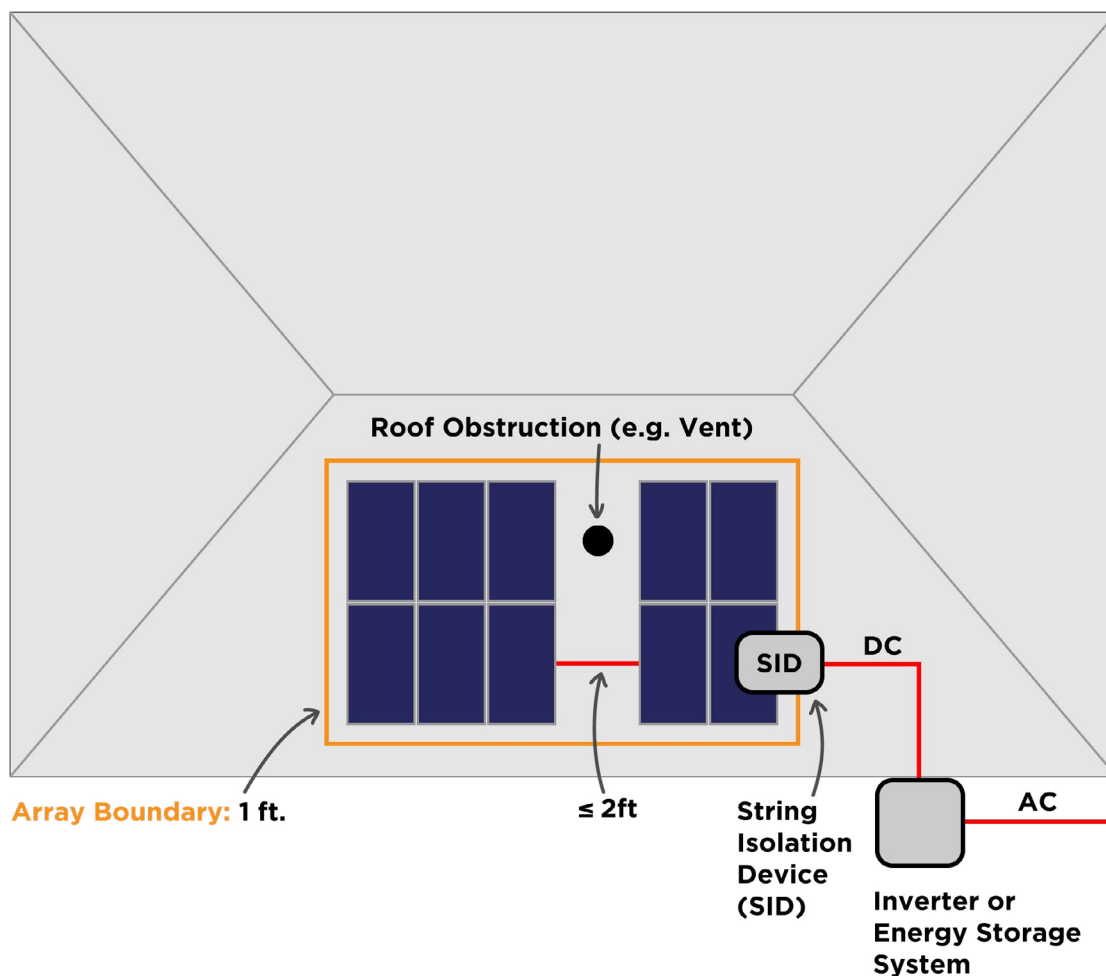

Case 2: Maintaining NEC Compliance with sub-array(s) within array boundary.

Multiple arrays with maximum 2 ft. spacing between array and sub-array result in a contiguous single array boundary and will require the use of a SID as shown above to control conductors outside of the array boundary.

IMPORTANT: Review electrical equipment page(s) for specific approved SID(s) and install methods.



Multiple arrays with multiple strings comply with NEC 690.12(B)(2)(1)

- **Outside Array Boundary:** $\leq 30V$ within 30 Seconds
- **Inside Array Boundary:** $\leq 600V$ Residential, 1000V Commercial

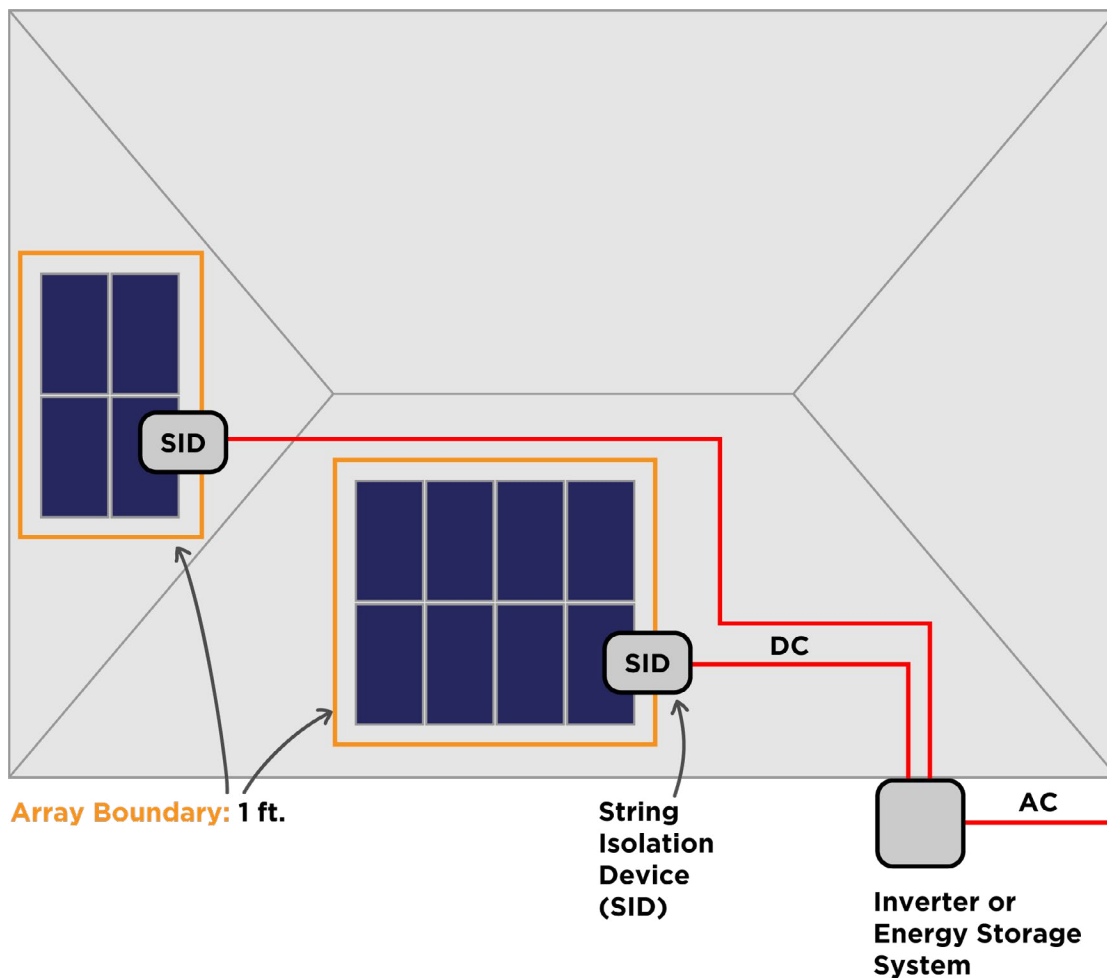

Case 3: Maintaining NEC Compliance with multiple arrays.

In multiple arrays with multiple strings, each string will require a SID. When a string is split across non-contiguous (>2ft) sub-arrays, a SID must be installed on both ends of the connection between sub-arrays as shown above to control conductors outside of the array boundary.

IMPORTANT: Review electrical equipment page(s) for specific approved SID(s) and install methods.

UL 3741 WIRE MANAGEMENT GUIDELINES

The XR Flush Mount wire management components noted in the list of approved PVHCS equipment on [Page 2](#) were evaluated and approved for providing wire positioning to prevent potential Fire Fighter (FF) interactions.

Proper wire management is critical for UL 3741 compliance and requires that all wires be routed in a manner that prevents exposure to potential FF interactions, such as routing wires under modules or through approved listed raceway for wires running between arrays.

See photos for examples of wire management.

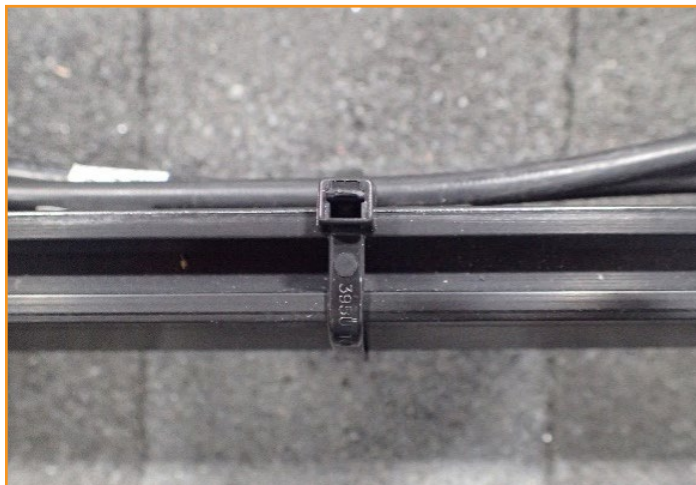

When running wires along the XR Rail, use the XR Wire Clip or the Cable Tie to secure wires to side of rail as shown above. Where needed, cut off any remaining cable tie after installation. Modules must cover all wires after installation. There shall be no visibly exposed wires after installation of modules. Do not overtighten or pinch the conductors.



When running wires north/south or east/west under a module, attach Edge Clip to module frame flange and use Cable Tie to secure wires to module frame. Where needed, cut off any remaining cable tie after installation. All wires must remain underneath the module after installation. There shall be no visibly exposed wires after installation of modules.

Any wires running to subarrays or other components that cannot be covered by a module shall be installed in approved electrical raceways such as the Listed Conduit types shown on page 2.

UL 3741 APPROVED MODULE LIST

The XR Flush Mount System has been tested and evaluated to UL 3741 and UL 2703. See approved modules below. Unless otherwise noted, "xxx" refers to the module power rating and both black and silver frames are included.

MAKE	MODELS
Adani	Adani modules with 40 mm frames ASB-7-AAA Where "AAA" is the power rating
Aionrise	AIONRISE modules with 35 and 40 mm frames AIONyyG1-xxx Where "yy" can be 60 or 72
Aptos Solar	Aptos Solar modules with 35 and 40 mm frames DNA-yy-zzaa-xxx Where "yy" can be 108, 120 or 144; "zz" can be MF or BF; and "aa" can be 10 or 26
Auxin	Auxin modules with 35 and 40 mm frames AXNCMzAxxxB Where "C" can be 6, 10 or G1; "z" can be blank, 610 or 612; and "A" can be blank or M; and "B" can be blank, A, B, C or W
Axitec	Axitec modules with 30 and 35 mm frames AC-xxxY/ZZb Where "Y" can be MH or MBT; "ZZ" can be 108, 120, or 144; "b" can be V or VB
Bluesun Solar	Bluesun Solar modules with 35 mm frames BSMxxxY-AAA Where "Y" can be M or M10; and "AAA" can be 54HPH or 60HPH
Boviet	Boviet modules with 35 mm frames BVMZZ12M-xxxAAA Where "ZZ" can be 66 or 76; and "AAA" can be H, H-HC, H-HC-BF, L-H-HC-BF, L-H-BF, L-H and L-H-HC, S-H-HC-BF and S-H-HC
BYD	BYD modules with 35 mm frames BYDxxxMLTK-36
Canadian Solar	Canadian Solar modules with 35 and 40 mm frames CSbY-xxxZ Where "b" can be 1, 3, 6 or 6.1; "Y" can be L, N, R, U, Y or -54TM; and "Z" can be H, M, MS or MS-HL
CertainTeed	CertainTeed modules with 30, 35 and 40 mm frames CTBBxxxHC11-AA Where "BB" can be blank or M10; and "AA" can be 06, 08 or 09
Crossroads Solar	Crossroads Solar modules with 40 mm frames Crossroads Solar xxx
CSUN	CSUN modules with 40 mm frames CSUNxxx-72MM5BB
Dehui	Dehui modules with 35 mm frames DH-MYYYYZ-xxx Where "YYY" can be 760, 772, 860, or 872; and "Z" can be B or W
Emmvee	Emmvee modules with 35 mm frames Exxx-YYZZZ-A Where "YY" can be M, P, HCM or HCMW; "ZZZ" can be 72, 120 or 144; and "A" can be blank or B
ET Solar	ET Solar modules with 35 and 40 mm frames ET-MZZZxxxAA Where "ZZZ" can be 660BH, 672, 672BH, 754BH, 766BH, 772BH; and "AA" can be TB, TW, WB or WW
Freedom Forever	Freedom Forever modules with 35 mm frames FF-MPa-BBB-xxx Where "a" can be blank or 1

UL 3741 APPROVED MODULE LIST

MAKE	MODELS
Freevolt	Freevolt modules with 35 mm frames ECP-PVGRAF-144HC-xxx
GCL	GCL modules with 35 mm frames GCL-M3/72DH
GreenWatts Solar	GreenWatts Solar modules with 30 and 35 mm frames HSYY-A-xxx-ZZ Where "YY" can be 54, 60, 66, 72 or 78; "A" can be blank or F; and "ZZ" can be MN or BOB
Goldi	Goldi modules with 35 mm frames GS10-Byyy-zz-xxx Where "yyy" can be 108 or 144; and "zz" can be GF or TF
Grape Solar	Grape Solar modules with 35 mm frames GS-M120-xxx-FAB1
Hansol	Hansol modules with 35 and 40 mm frames HSxxxYY-HH2 Where "YY" can be UB or UD
Hanwha Q CELLS	Hanwha Q CELLS modules with 32, 35, 40 mm frames Q.YY-ZZ-xxx Where "YY" can be PEAK DUO or Tron; and "ZZ" can be M-G2+, BLK M-G2+, L-G7.3, BLK-G6+/HL, BLK-G10, BLK-G10+, BLK G10+/AC, BLK-G10+/HL, ML-G10, BLK ML-G10, ML-G10+, BLK ML-G10+, ML-G10.a, BLK ML-G10.a, ML-G10.a+, BLK ML-G10.a+, BLK ML-G10 +/t, BLK ML-G10+/TS, XL-G10.2, XL-G10.3, XL-G10.c, XL-G10.d, XL-G11.2 or XL-G11.3
Heliene	Heliene modules with 35 and 40 mm frames YYZZxxxA Where "YY" can be 96, 108, 120, 132, 144 or 156; "ZZ" can be HC or M; and "A" can be blank, Bifacial, M10-SL, M10 TPC SL, M10-SL-BLK, M10 Bifacial or M10 SL-Bifacial
HT-SAAE	HT-SAAE modules with 35 mm frames HTyy-aaaZ-xxx Where "yy" can be 60, 66, 72 or 78, "aaa" can be 18 or 166; and "Z" can be M or X
Hyundai	Hyundai modules with 32, 35 and 40 mm frames HiY-SxxxZZ Where "Y" can be A or S; "S" can be M or S; and "ZZ" can be HG, OJ, PI, TI, YH(BK) or XG(BK)
JA Solar	JA Solar modules with 30, 35 and 40 mm frames JAMzzbb-xxx/MR Where "zz" can be 54, 66, 72 or 78; "bb" can be S10, S20, S30 or S31
Jakson Solar	Jakson Solar modules with 35mm frames JH-xxxYY Where "YY" can be BB or BT
Jinko	Jinko modules with 35 and 40 mm frames JKMxxxZ-aa Where "Z" can be M or N; "aa" can be 54HL4-B, 6RL3-B, 6TL3-B, 72HBL-V, 72HL4-V, 72HL4-TV, 7RL3-V or 7RL3-TV
KB Solar	KB Solar modules with 35 mm frames KBS-xxx-Mono-YY Where "YY" can be blank or BF
LA Solar	LA Solar modules with 35 mm frames LSxxxYY Where "YY" can be BF, BL, BLA, HC or ST
LG	LG modules with 35 and 40 mm frames LGxxxYaZ-bb Where "Y" can be A, M, N or Q; "a" can be A, 1, 2 or 3 "Z" can be C, K, T, or W; and "bb" can be A6, B6, E6, E6.AW5, L5, N5, V6

UL 3741 APPROVED MODULE LIST

MAKE	MODELS
Longi	Longi modules with 30 and 35 mm frames LRa-YYZZ-xxxM Where "a" can be 4 or 5; "YY" can be 54, 60, 66, or 72; and "ZZ" can be HPB or HPH
Maxeon	Maxeon modules with 35, 40 and 46 mm frames SPR-AAAY-xxx-zzz Where "AAA" can be X or MAX; "Y" can be 3, 5, 6, 21 or 22; and "zzz" can be R, BLK, BLK-R or COM
Meyer Burger	Meyer Burger modules with 35 mm frames Meyer Burger Black or White
Mission Solar (mSolar)	Mission Solar modules with 35 and 40 mm frames YYYbb-xxxZZaa Where "YYY" can be MSE, TXI or TXS; "bb" can be blank, 6 or 10; "ZZ" can be blank, HT, SQ, SX, 108, 120 or 144; and "aa" can be blank, 0B, 2B, BB, BW, 5K, 5R, 5T, 6J, 6S, 6W, 6Z, 9R, 9S or 9Z
Mitrex	Mitrex modules with 30 and 40 mm frames Mxxx-XYZ Where "X" can be A, B, I or L; "Y" can be 1 or 3; and "Z" can be F or H
Navitas	Navitas modules with 35 mm frames NSMxxx-yyy Where "yyy" can be 120, 132 or 144
NE Solar	NE Solar modules with 30 and 35 mm frames NESExxx-zzMH-yy Where "zz" can be 54, 60 or 72; and "yy" can be M6 or M10
Neo Solar Power	Neo Solar modules with 35 mm frames D6MxxxE4A
Panasonic (EverVolt)	Panasonic modules with 30 mm frames EVPVxxxA Where "A" can be blank or H, K, HK, HK2 or PK
Philadelphia Solar	Philadelphia Solar modules with 30, 35 and 40 mm frames PS-YzzAA-xxxW Where "Y" can be M, MNB or P; "zz" can be 60, 72, 108 or 144; "AA" can be blank, (BF), (HC) or (HCBF); and "W" can be blank or W
Phono Solar	Phono Solar modules with 30, 35 and 40 mm frames PSxxxY-ZZ/A Where "Y" can be M, M1, MH, M4, M4H, M6, M6H, M8, or M8H; "ZZ" can be 18, 20 or 24; and "A" can be TH, THB, UH, UHB or VHB
Prism Solar	Prism Solar modules with 35 mm frames PST-xxxW-M72Y Where "Y" can be H, HB or HBI
Rayzon Solar	Rayzon Solar modules with 35 and 40 mm frames RSYxxxWC Where "Y" can be blank or B
REC Solar	REC Solar modules with 30 and 38 mm frames RECxxxYYZZ Where "YY" can be AA, NP2, NP3, TP3M or TP4; and "ZZ" can be blank, 72, Black, Pure, Pure-R, Pure-RX or Pure 2
Renogy	Renogy modules with 35 and 40 mm frames RYY-xxxD-AAA Where "YY" can be NG or SP; "AAA" can be blank, 144, BB-108, BB-120 or BK-120
Saatvik	Saatvik modules with 35 mm frames SGExxx-YYYZZZ Where "YYY" can be 108 or 144; and "ZZZ" can be MHC, MBHC or MHCB

UL 3741 APPROVED MODULE LIST

MAKE	MODELS
S-Energy	S-Energy modules with 35 and 40 mm frames SABB-CCYYY-xxxV Where "A" can be C, L or N; "BB" can be 20, 40 or 45; "CC" can be blank, 60 or 72; "YYY" can be blank MAE, MAI, MBE, MBI, MCE or MCI
SEG Solar	SEG Solar modules with 35 mm frames SEG-xxxZZ-AA Where "ZZ" can be BMA, BMB, BMD; and "AA" can be HV or TB
Seraphim USA	Seraphim modules with 35 mm frames SRP-xxx-YYY-HV Where "YYY" can be BMA or BMD
Shinsung E&G	Shinsung modules with 35 mm frames SSVxxx-144MH
Silfab	Silfab modules with 35 and 38 mm frames SIL-xxxYY Where "YY" can be BG, BK, BL, HC, HC+, HL, HM, HN, NL, NU, NX, QD or QM
Sirius PV	Sirius PV modules with 35 mm frames ELNSMzzM-HC-xxx Where "zz" can be 54 or 72
Solar4America	Solar4America modules with 30, 35 and 40 mm frames S4Axxx-YYzzAA Where "YY" can be 60, 72, 108 or 144; "zz" can be MH5 or MH10; and "AA" can be blank or BB, BW, SW or STT
Solarever	Solarever modules with 35 mm frames SE-zzz*yy-xxxM-aaa Where "zzz" can be 166 or 182; "yy" can be 83 or 91; and "aaa" can be 108, 144 or 144N
Solaria	Solaria modules with 35 mm frames PowerA-xxxY-ZZ Where "A" can be X or XT, "Y" can be R; and "ZZ" can be PL or 4T
SolarTech	SolarTech modules with 40 mm frames AAA-xxx Where "AAA" can be PERCB-B, PERCB-W, HJT B-B, HJT B-W
Sonali	Sonali modules with 35 mm frames SS-M-xxx
Star Solar	Star Solar modules with 35 mm frames Star-xxxW-YYY-ZZZ Where "YYY" can be M60H or M60HB; and "ZZZ" can be blank or M10
Sunmac Solar	Sunmac modules with 30 and 35 mm frames SMxxxMaaaZZ-YY Where "aaa" can be 660, 754 or 772; "ZZ" can be NH or SH; and "YY" can be BB or TB
Sunpower	Sunpower modules, standard (G3 or G4) or InvisiMount (G5) with 35, 40 and 46 mm frames SPR-Z-xxx-YY Where "Z" can be A, M or P19; "YY" can be COM, BLK-G-AC, H-AC or BLK-H-AC
Sunspark	Sunspark modules with 40 mm frames SST-xxxZ-A Where "Z" can be M3 or M3B; and "A" can be 60 or 72
Suntech	Suntech modules with 35 and 40 mm frames STPxxxS-zz/aa Where "zz" can be A60, A72U, B60 or B72; and "aa" can be VfH, Vnh, WfHb or Wnhb
Talesun	Talesun modules with 30, 35 and 40 mm frames TPByZZaa-xxx Where "B" can be 6 or 7; "y" can be blank, F, G or L; "ZZ" can be 54, 60 or 72; "aa" can be M or M(H)

UL 3741 APPROVED MODULE LIST

MAKE	MODELS
Tesla	Tesla modules with 40 mm frames TxxxY Where "Y" can be H or S
Thornova	Thornova modules with 30 and 35 mm frames TS-BBZZ(XXX)-X Where "ZZ" can be 54 or 60; and "X" can be blank or X
Trina	Trina modules with 30 and 35 mm frames TSM-xxxYYZZ Where "YY" can be DE15V, DE18M, DE09, DE19, DE06X or NE09RC; and "ZZ" can be blank, .05, .05(II), C.05, C.05(II), C.07, C.07(II), (II), .08(II), 19
Universal	Universal modules with 35 mm frames UNI-xxx-yyyZZZ-aa Where "yyy" can be 108, 120 or 144; "ZZZ" can be M, MH, BMH; and "aa" can be blank or BB
URE	URE modules with 35 mm frames DyZxxxxaa Where "D" can be D or F, "y" can be A, B or 6; "Z" can be F, K or M; and "aa" can be C8G, DFG-BB, H4A, E7G-BB, E8G, E8G-BB, MFG, MFG-BB or M7G-BB
Vikram	Vikram modules with 35 mm frames XVSyy.ZZ.AAA.05 Where "X" can be Prexos or Somera; "yy" can be MDHT, MH or MHBB; "ZZ" can be 54, 60 or 72; "AAA" is the module power rating
Waaree	Waaree modules with 35 mm frames XXYYxxx Where "XX" can be Bi or WS; and "YY" can be MDI, MDIB, 33 or 57
VSUN	VSUN modules with 30, 35 and 40 mm frames VSUNxxxA-YYz-aa Where "A" can be blank or N; "YY" can be 60, 72, 108, 120, 132, 144; "z" can be M, MH or BMH; and "aa" can be blank, BB, BW, or DG
Yingli	Yingli modules with 30 and 35 mm frames YLxxxD-yy Where "yy" can be 34d, 37e 1/2, 37e 1500V 1/2, 40d, 49e 1/2 or 49e 1500V 1/2
Zeus	Zeus modules with 40 mm frames ZxxxM-HB
ZN Shine	ZN Shine modules with 30 and 35 mm frames ZXYM-AAA-xxx/M Where "Y" can be 6, 7 or 8; "AAA" can be 72, NH120, NH144, NHDB144, SH108, SH144, SHDB144 or TP120