



samlexpower®

**Evolution™ Series
Inverter Charger**
Pure Sine Wave

Models:
EVO-2212
EVO-3012
EVO-2224
EVO-4024

Owner's
Manual

Please read this
manual BEFORE
operating.

SECTION 1

Safety Instructions & General Information 3

SECTION 2

Components & Layout 24

SECTION 3

Installation 28

SECTION 4

General Description and Principles of Operation 59

SECTION 5

Battery Charging in Evolution Series 70

SECTION 6

Operation, Protections and Troubleshooting 78

SECTION 7

Specifications 85

SECTION 8

Warranty 88

APPENDIX A

EVO-RC (Optional Remote Control) Owner's Manual

SECTION 1 | Safety Instructions & General Information

1.1 IMPORTANT SAFETY INSTRUCTIONS

SAVE THESE INSTRUCTIONS. THIS MANUAL CONTAINS IMPORTANT INSTRUCTIONS FOR MODELS: EVO-2212, EVO-2224, EVO-3012, EVO-4024 THAT SHALL BE FOLLOWED DURING INSTALLATION & MAINTENANCE OF THE INVERTER CHARGER.

THE FOLLOWING SYMBOLS WILL BE USED IN THIS MANUAL TO HIGHLIGHT SAFETY AND IMPORTANT INFORMATION:



WARNING!

Indicates possibility of physical harm to the user in case of non-compliance.

ATTENTION!

Il y a une possibilité de faire du mal physique à l'utilisateur si les consignes de sécurité sont pas suivies



CAUTION!

Indicates possibility of damage to the equipment in case of non-compliance.

ATTENTION!

Il y a une risque de faire des dégâts à l'équipement si l'utilisateur ne suit pas les instructions



INFO

Indicates useful supplemental information.

Please read these instructions BEFORE installing or operating the unit to prevent personal injury or damage to the unit.



WARNING!

1. **DANGER!** To reduce risk of explosion, do not install in machinery space or in area in which ignition-protected equipment is required to be used.
2. **CAUTIONS!** (a) To prevent damage due to excessive vibration / shock, use on marine vessels with lengths more than 65 ft. (19.8M). (b) This unit is NOT designed for weather-deck installation. To reduce risk of electrical shock, do not expose to rain or spray.
3. **CAUTIONS!** (a) EVO Inverter/Charger with fully automatic charging circuit charges only properly rated 12V (6 Cell) / 24V (12 Cell) Lead Acid Batteries (Gel Cell, AGM, Flooded, Lead Antimony / Lead Calcium) and (b) When EVO Inverter/Charger is in Charge Mode, Green LED marked "ON" would be flashing.
4. For indoors use only.
5. **Hot Surfaces!** To prevent burns, do not touch.

SECTION 1 | Safety Instructions & General Information

6. The AC input / output wiring terminals are intended for field connection using Copper conductors that are to be sized based on 75°C and NOT larger than AWG #1(42.4 mm²). See Tables 1.1(a), 1.1 (b) and 1.1 (c) for sizing of conductors for AC INPUT circuits and Table 1.2 for sizing of conductors for AC OUTPUT circuits.
7. Over current protection (AC Breakers) for the AC input / output circuits has NOT been provided and has to be provided by the installer / user. See guidelines at Tables 1.1(a), 1.1 (b) and 1.1 (c) for sizing of breakers for AC INPUT circuits and Table 1.2 for sizing of breakers for AC OUTPUT circuits. National and Local Electrical Codes will supersede these guidelines.
8. The battery terminals are intended for field connection using Copper conductors that are sized based on 90°C and are LARGER than AWG #1(42.4 mm²). See Tables 1.3(a) and 1.3(b) for recommended sizes for installation in free air and conduit respectively.
9. Over current protection (fuse) for battery and External Charger circuits has NOT been provided and has to be provided by the installer / user. See guidelines at Tables 1.3(a) and 1.3(b) for recommended sizes for installation in free air and conduit respectively. National and Local Electrical Codes will supersede these guidelines.
10. Tightening torques to be applied to the wiring terminals are given in Table 1.4.
11. This unit has been provided with integral protections against overloads.
12. **WARNING!** To reduce risk of electric shock and fire:
 - Installation should be carried out by certified installer and as per Local and National Electrical Codes.
 - Do not connect to circuit operating at more than 150 Volts to Ground.
 - Do not connect to AC Load Center (Circuit Breaker Panel) having Multi-wire Branch Circuits connected .
 - Both AC and DC voltage sources are terminated inside this equipment. Each circuit must be individually disconnected before servicing.
 - Do not remove cover. No user serviceable part inside. Refer servicing to qualified servicing personnel.
 - Do not mount in zero clearance compartment.
 - Do not cover or obstruct ventilation openings.
 - Fuse(s) should be replaced with the same type and rating as of the original installed fuse(s).
13. **WARNING!** Risk of electric shock. Use only those GFCIs that are listed at Table 1.5. Other types may fail to operate properly when connected to this unit.
14. **GROUNDING:** The Grounding symbol shown below is used for identifying only the field wiring equipment-grounding terminal. However, this symbol is usable with the circle omitted for identifying various points within the unit that are bonded to Ground.



Grounding Symbol / Défaut à la terre

15. Precautions When Working With Batteries.
 - Batteries contain very corrosive diluted Sulphuric Acid as electrolyte. Precautions should be taken to prevent contact with skin, eyes or clothing. Wear eye protection.

SECTION 1 | Safety Instructions & General Information

- Batteries generate Hydrogen and Oxygen during charging resulting in evolution of explosive gas mixture. Care should be taken to ventilate the battery area and follow the battery manufacturer's recommendations.
- Never smoke or allow a spark or flame near the batteries.
- Use caution to reduce the risk of dropping a metal tool on the battery. It could spark or short circuit the battery or other electrical parts and could cause an explosion. Always use insulated tools.
- Remove metal items like rings, bracelets and watches when working with batteries. Batteries can produce a short circuit current high enough to weld a ring or the like to metal and thus cause a severe burn.
- If you need to remove a battery, always remove the Ground terminal from the battery first. Make sure that all the accessories are off so that you do not cause a spark.

TABLE 1.1 (a) SIZING OF AC INPUT WIRING AND BREAKERS (FOR DEFAULT AC INPUT CURRENT LIMIT PROGRAMMED AT 30A FOR EVO=2212, EVO-2224, EVO-3012, EVO-4024)				
Item (Column 1)	Programmed Input Cur- rent Limit (Column 2)	NEC Ampac- ity = 125% of Column 2 (Column 3)	Size based on NEC Ampac- ity at Column 3 and 75°C Copper Conductor in Conduit (Column 4)	Breaker Size (Based on NEC Ampac- ity at Column 3) (Column 5)
EVO-2212	30A (Default)	37.5A	AWG #8	40A
EVO-2224				
EVO-3012				
EVO-4024				

TABLE 1.1 (b) AC INPUT WIRING AND BREAKERS (FOR AC INPUT CURRENT LIMIT PROGRAMMED AT 45A FOR EVO-3012 AND EVO-4024)				
Item (Column 1)	Programmed Input Cur- rent Limit (Column 2)	NEC Ampac- ity = 125% of Column 2 (Column 3)	Wire Size based on NEC Ampacity at Column 3 and 75°C Copper Conductor in Conduit (Column 4)	Breaker Size (Based on NEC Ampac- ity at Column 3) (Column 5)
EVO-3012	45A	56.25A	AWG #6	60A
EVO-4024				

TABLE 1.1 (c) AC INPUT WIRING AND BREAKERS (FOR AC INPUT CURRENT LIMIT PROGRAMMED AT 60A FOR EVO-4024)				
Item (Column 1)	Pro- grammed Input Cur- rent Limit (Column 2)	NEC Ampac- ity = 125% of Column 2 (Column 3)	Wire Size based on NEC Ampacity at Column 3 and 75°C Copper Conductor in Conduit (Column 4)	Breaker Size (Based on NEC Ampac- ity at Column 3) (Column 5)
EVO-4024	60A	75A	AWG #4 or 2 X AWG #6	80A

SECTION 1 | Safety Instructions & General Information

Table 1.2 AC OUTPUT WIRING AND BREAKERS				
Item (Column 1)	Rated AC Output Current in Inverter Mode (Column 2)	NEC Ampacity = 125% of Column 2 (Column 3)	Wire Size based on NEC Ampacity at Column 3 and 75°C Copper Conductor in Conduit (Column 4)	Breaker Size (Based on NEC Ampacity at Column 3) (Column 5)
EVO-2212	18.33A	22.91	AWG #10	25A
EVO-2224	18.33A	22.91	AWG #10	25A
EVO-3012	25A	31.25	AWG #8	35A
EVO-4024	33.33A	41.66	AWG #8	45A

TABLE 1.3(a) BATTERY CABLES IN <u>FREE AIR</u> AND EXTERNAL BATTERY SIDE FUSES			
Item	Copper, 90°C		Fuse
	Up to 5 ft.	Up to 10 ft.	
EVO-2212	AWG #3/0	AWG #4/0	350A
EVO-2224	AWG #2	AWG #2	175A
EVO-3012	2 X AWG #3/0 (MCM 300)	2 X AWG #3/0 (MCM 300)	500A
EVO-4024	AWG #3/0	AWG #4/0	350A
External Charger	AWG #6	AWG #2	70A

TABLE 1.3 (B) BATTERY CABLES IN <u>RACEWAY</u> AND EXTERNAL BATTERY SIDE FUSES			
Item	Copper, 90°C		Fuse
	Up to 5 ft.	Up to 10 ft.	
EVO-2212	2 X AWG #4/0 (MCM 350)	2 X AWG #4/0 (MCM 350)	350A
EVO-2224	AWG #1/0	AWG #1/0	175A
EVO-3012	Not recommended	Not recommended	500A
EVO-4024	2 X AWG #4/0 (MCM 350)	2 X AWG #4/0 (MCM 350)	300A
External Charger	AWG #6	AWG #2	70A

TABLE 1.4 TIGHTENING TORQUES		
Battery Input Connectors	External Charger Input Connectors	AC Input and Output Connectors
70 kgf.cm (5.0 lbf.ft)	35 kgf.cm (2.5 lbf.ft)	7 to 12 kgf.cm (0.5 to 0.9 lbf.ft)

SECTION 1 | Safety Instructions & General Information

TABLE 1.5 USE OF SPECIFIED GROUND FAULT CIRCUIT INTERRUPTER (GFCI) FOR DISTRIBUTION OF AC OUTPUT POWER IN RECREATION VEHICLES

Manufacturer of GFCI	Manufacturers' Model No.	Description
Pass & Seymour	2095W	NEMA5-20, Duplex, 20A
Pass & Seymour	1595W	NEMA5-15, Duplex, 15A
Leviton	7899-W	NEMA5-20, Duplex, 20A
Leviton	T7599W	NEMA5-15, Duplex, 15A
Leviton	7599W	NEMA5-15, Duplex, 15A



ATTENTION!

- DANGER! Pour réduire les risques d'explosion, ne pas installer dans les locaux de machines ou dans la zone où l'équipement protégé contre les incendies doit être utilisé.
- 2 ATTENTION! Cet appareil est conçu pour une installation PAS Météo-pont. Pour réduire les risques de choc électrique, ne pas exposer à la pluie ou à la neige.
- Pour une utilisation en intérieur uniquement.
- Pour éviter les dommages dus à des vibrations excessives / choc, ne pas utiliser sur les navires plus petits avec des longueurs de moins de 65 pi. (19,8).
- Surfaces chaudes! Pour éviter les brûlures, ne touchez pas.
- Les bornes de câblage entrée / sortie CA sont prévus pour un raccordement sur le terrain avec des conducteurs de cuivre qui doivent être dimensionnés en fonction de 75 ° C et ne dépasse pas AWG n ° 1 (42,4 mm2). Voir les tableaux 1.1 (a), 1.1 (b) et 1.1 (c) pour le dimensionnement des conducteurs pour les circuits d'entrée CA et le tableau 1.2 pour le dimensionnement des conducteurs pour les circuits de sortie AC.
- Protection contre les surintensités (AC Breakers) pour les circuits d'entrée / sortie AC n'a pas été fournis et doit être fourni par l'installateur / utilisateur. Voir les lignes directrices à tableaux 1.1 (a), 1.1 (b) et 1.1 (c) pour le dimensionnement des disjoncteurs pour les circuits d'entrée CA et le tableau 1.2 pour le dimensionnement des disjoncteurs pour les circuits de sortie AC. Codes électriques nationaux et locaux remplaceront ces lignes directrices.
- Les bornes de la batterie sont conçus pour se connecter sur le terrain avec des conducteurs en cuivre qui sont dimensionnés en fonction de 90 ° C et sont plus grandes que AWG n ° 1 (42,4 mm2). Voir les tableaux 1.3 (a) et 1.3 (b) pour les tailles recommandées pour l'installation à l'air libre et conduit respectivement.
- Protection contre les surintensités (fusible) pour la batterie et les circuits chargeur externe n'a pas été fournis et doit être fourni à l'installateur / utilisateur. Voir les lignes directrices à tableaux 1.3 (a) et 1.3 (b) pour les tailles recommandées pour l'installation à l'air libre et conduit respectivement. Codes électriques nationaux et locaux remplaceront ces lignes directrices.
- Couples de serrage pour être appliqués sur les bornes de câblage sont donnés dans le tableau 1.4.
- Cet appareil a été fourni avec des protections intégrées contre les surcharges.
- ATTENTION! Pour réduire les risques de choc électrique et d'incendie:
 - L'installation doit être effectuée par un installateur certifié et selon les codes électriques locaux et nationaux
 - Ne pas se connecter au circuit fonctionnant à plus de 150 volts à la terre
 - Ne pas se connecter au Centre de charge AC (Circuit de panneau de disjoncteurs) ayant Direction Multi-fil circuits reliés
 - Les deux sources de tension AC et DC sont terminées à l'intérieur de cet équipement. Chaque circuit doit être déconnecté individuellement avant l'entretien
 - Ne pas retirer le couvercle. Aucune partie réparable par l'utilisateur à l'intérieur. Faites appel à un installateur qualifié
 - Ne pas monter dans zéro compartiment de jeu
 - Ne pas couvrir ou obstruer les ouvertures de ventilation.
 - Fusible (s) doit être remplacé par le même type de fusible du fusible installé d'origine (s)

SECTION 1 | Safety Instructions & General Information

13. ATTENTION! Risque de choc électrique. Utilisez uniquement les GFCIs suivantes. D'autres types peuvent ne pas fonctionner correctement lorsqu'il est connecté à cet appareil.
14. MISE À LA TERRE: Le symbole de mise à la terre ci-dessous est utilisé pour identifier uniquement l'équipement terminal de terre-câblage. Toutefois, ce symbole est utilisable avec le cercle omis pour identifier divers points de l'unité qui sont liés à la masse.

Grounding Symbol / Défaut à la terre



15. Précautions lorsque vous travaillez avec des piles.
 - Les piles contiennent très corrosif acide sulfurique dilué comme électrolyte. Des précautions doivent être prises pour empêcher tout contact avec la peau, les yeux ou les vêtements. Porter des lunettes de protection
 - Les batteries produisent de l'hydrogène et de l'oxygène lors de la charge résultant de l'évolution du mélange de gaz explosif. Il faut prendre soin de ventiler la zone de la batterie et de suivre les recommandations du fabricant de la batterie.
 - Ne jamais fumer ou permettre une étincelle ou une flamme près des batteries.
 - Faites preuve de prudence afin de réduire le risque de chute d'un outil métallique sur la batterie. Il pourrait provoquer un court-circuit ou la batterie ou d'autres pièces électriques et pourrait causer une explosion. Toujours utiliser des outils isolés
 - Retirez les articles métalliques tels que des bagues, des bracelets et des montres lorsque vous travaillez avec des batteries. Les batteries peuvent produire un court-circuit suffisamment élevé pour souder une bague ou autre métal et ainsi causer de graves brûlures.
 - Si vous devez retirer la batterie, retirez toujours la borne de terre de la batterie. Assurez-vous que tous les accessoires sont hors de sorte que vous ne causent pas une étincelle.

1.2 DEFINITIONS

The following definitions are used in this manual for explaining various electrical concepts, specifications and operations:

Peak Value: It is the maximum value of electrical parameter like voltage / current.

RMS (Root Mean Square) Value: It is a statistical average value of a quantity that varies in value with respect to time. For example, a pure sine wave that alternates between peak values of Positive 169.68V and Negative 169.68V has an RMS value of 120 VAC. Also, for a pure sine wave, the RMS value = Peak value \div 1.414.

Voltage (V), Volts: It is denoted by "V" and the unit is "Volts". It is the electrical force that drives electrical current (I) when connected to a load. It can be DC (Direct Current – flow in one direction only) or AC (Alternating Current – direction of flow changes periodically). The AC value shown in the specifications is the RMS (Root Mean Square) value.

Current (I), Amps, A: It is denoted by "I" and the unit is Amperes – shown as "A". It is the flow of electrons through a conductor when a voltage (V) is applied across it.

Frequency (F), Hz: It is a measure of the number of occurrences of a repeating event per unit time. For example, cycles per second (or Hertz) in a sinusoidal voltage.

Efficiency, (η): This is the ratio of Power Output \div Power Input.

Phase Angle, (ϕ): It is denoted by " ϕ " and specifies the angle in degrees by which the current vector leads or lags the voltage vector in a sinusoidal voltage. In a purely inductive load, the current vector lags the voltage vector by Phase Angle (ϕ) = 90°. In a purely capacitive load, the current vector leads the voltage vector by Phase Angle, (ϕ) = 90°. In a purely resistive load, the current vector is in phase with the voltage vector and hence, the Phase Angle, (ϕ) = 0°. In a load

SECTION 1 | Safety Instructions & General Information

consisting of a combination of resistances, inductances and capacitances, the Phase Angle (ϕ) of the net current vector will be $> 0^\circ < 90^\circ$ and may lag or lead the voltage vector.

Resistance (R), Ohm, Ω : It is the property of a conductor that opposes the flow of current when a voltage is applied across it. In a resistance, the current is in phase with the voltage. It is denoted by "R" and its unit is "Ohm" - also denoted as " Ω ".

Inductive Reactance (X_L), Capacitive Reactance (X_C) and Reactance (X): Reactance is the opposition of a circuit element to a change of electric current or voltage due to that element's inductance or capacitance. Inductive Reactance (X_L) is the property of a coil of wire in resisting any change of electric current through the coil. It is proportional to frequency and inductance and causes the current vector to lag the voltage vector by Phase Angle (ϕ) = 90° . Capacitive reactance (X_C) is the property of capacitive elements to oppose changes in voltage. X_C is inversely proportional to the frequency and capacitance and causes the current vector to lead the voltage vector by Phase Angle (ϕ) = 90° . The unit of both X_L and X_C is "Ohm" - also denoted as " Ω ". The effects of inductive reactance X_L to cause the current to lag the voltage by 90° and that of the capacitive reactance X_C to cause the current to lead the voltage by 90° are exactly opposite and the net effect is a tendency to cancel each other. Hence, in a circuit containing both inductances and capacitances, the net **Reactance (X)** will be equal to the difference between the values of the inductive and capacitive reactances. The net **Reactance (X)** will be inductive if $X_L > X_C$ and capacitive if $X_C > X_L$.

Impedance, Z: It is the vectorial sum of Resistance and Reactance vectors in a circuit.

Active Power (P), Watts: It is denoted as "P" and the unit is "Watt". It is the power that is consumed in the resistive elements of the load. A load will require additional Reactive Power for powering the inductive and capacitive elements. The effective power required would be the Apparent Power that is a vectorial sum of the Active and Reactive Powers.

Reactive Power (Q), VAR: Is denoted as "Q" and the unit is VAR. Over a cycle, this power is alternatively stored and returned by the inductive and capacitive elements of the load. It is not consumed by the inductive and capacitive elements in the load but a certain value travels from the AC source to these elements in the (+) half cycle of the sinusoidal voltage (Positive value) and the same value is returned back to the AC source in the (-) half cycle of the sinusoidal voltage (Negative value). Hence, when averaged over a span of one cycle, the net value of this power is 0. However, on an instantaneous basis, this power has to be provided by the AC source. *Hence, the inverter, AC wiring and over current protection devices have to be sized based on the combined effect of the Active and Reactive Powers that is called the Apparent Power.*

Apparent (S) Power, VA: This power, denoted by "S", is the vectorial sum of the Active Power in Watts and the Reactive Power in "VAR". In magnitude, it is equal to the RMS value of voltage "V" X the RMS value of current "A". The Unit is VA. *Please note that Apparent Power VA is more than the Active Power in Watts. Hence, the inverter, AC wiring and over current protection devices have to be sized based on the Apparent Power.*

Power Factor, (PF): It is denoted by "PF" and is equal to the ratio of the Active Power (P) in Watts to the Apparent Power (S) in VA. The maximum value is 1 for resistive types of loads where the Active Power (P) in Watts = the Apparent Power (S) in VA. It is 0 for purely inductive or purely capacitive loads. Practically, the loads will be a combination of resistive, inductive and

SECTION 1 | Safety Instructions & General Information

capacitive elements and hence, its value will be $> 0 < 1$. Normally it ranges from 0.5 to 0.8.

Load: Electrical appliance or device to which an electrical voltage is fed.

Linear Load: A load that draws sinusoidal current when a sinusoidal voltage is fed to it. Examples are, incandescent lamp, heater, electric motor, etc.

Non-Linear Load: A load that does not draw a sinusoidal current when a sinusoidal voltage is fed to it. For example, non-power factor corrected Switched Mode Power Supplies (SMPS) used in computers, audio video equipment, battery chargers, etc.

Resistive Load: A device or appliance that consists of pure resistance (like filament lamps, cook tops, toaster, coffee maker etc.) and draws only Active Power (Watts) from the inverter. The inverter can be sized based on the Active Power rating (Watts) of the Resistive Load without creating overload (except for resistive loads with Tungsten based heating element like filament lamps, Quartz/Halogen lamps and Quartz heaters. These require higher starting surge power due to lower resistance value when the heating elements are cold).

Reactive Load: A device or appliance that consists of a combination of resistive, inductive and capacitive elements (like motor driven tools, refrigeration compressors, microwaves, computers, audio/ video etc.). These devices require Apparent Power (VA) from the inverter to operate. The Apparent Power is a vectorial sum of Active Power (Watts) and Reactive Power (VAR). *The inverter has to be sized based on the higher Apparent Power (VA) and also based on starting surge power.*

1.3 GENERAL INFORMATION - INVERTER RELATED

General information related to operation and sizing of inverters is given in succeeding sub-sections.

1.3.1 AC Voltage Waveforms

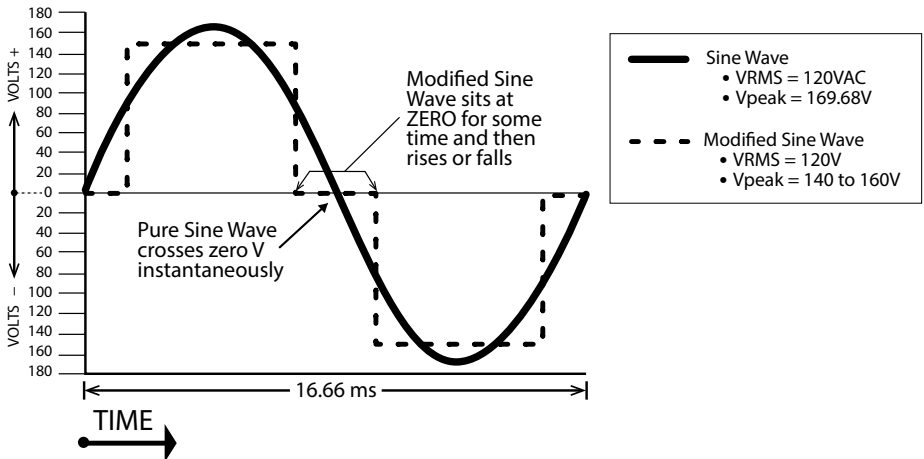

Fig 1.1 Pure and Modified Sine Waveforms for 120V, 60 Hz

SECTION 1 | Safety Instructions & General Information

The 120V output waveform of the Evolution series inverters is a pure sine wave like the waveform of the grid power. Please see sine waveform represented in the Fig. 1.1 that also shows equivalent modified waveform for comparison.

In a sine wave, the voltage rises and falls smoothly with a smoothly changing phase angle and also changes its polarity instantly when it crosses 0 Volts. In a modified sine wave, the voltage rises and falls abruptly, the phase angle also changes abruptly and it sits at 0V for some time before changing its polarity. Thus, any device that uses a control circuitry that senses the phase (for voltage / speed control) or instantaneous zero voltage crossing (for timing control) will not work properly from a voltage that has a modified sine waveform.

Also, as the modified sine wave is a form of square wave, it is comprised of multiple sine waves of odd harmonics (multiples) of the fundamental frequency of the modified sine wave. For example, a 60 Hz modified sine wave will consist of sine waves with odd harmonic frequencies of 3rd (180 Hz), 5th (300 Hz), 7th (420 Hz) and so on. The high frequency harmonic content in a modified sine wave produces enhanced radio interference, higher heating effect in inductive loads like microwaves and motor driven devices like hand tools, refrigeration / air-conditioning compressors, pumps etc. The higher frequency harmonics also produce overloading effect in low frequency capacitors due to lowering of their capacitive reactance by the higher harmonic frequencies. These capacitors are used in ballasts for fluorescent lighting for Power Factor improvement and in single-phase induction motors as start and run capacitors. Thus, modified and square wave inverters may shut down due to overload when powering these devices.

1.3.2 Advantages of Pure Sine Wave Inverters

- The output waveform is a sine wave with very low harmonic distortion and cleaner power like utility supplied electricity.
- Inductive loads like microwaves, motors, transformers etc. run faster, quieter and cooler.
- More suitable for powering fluorescent lighting fixtures containing power factor improvement capacitors and single phase motors containing start and run capacitors.
- Reduces audible and electrical noise in fans, fluorescent lights, audio amplifiers, TV, fax and answering machines.
- Does not contribute to the possibility of crashes in computers, weird print outs and glitches in monitors.

Some examples of devices that may not work properly with modified sine wave and may also get damaged are given below:

- Laser printers, photocopiers, and magneto-optical hard drives.
- Built-in clocks in devices such as clock radios, alarm clocks, coffee makers, bread-makers, VCR, microwave ovens etc. may not keep time correctly.
- Output voltage control devices like dimmers, ceiling fan / motor speed control may not work properly (dimming / speed control may not function).
- Sewing machines with speed / microprocessor control.
- Transformer-less capacitive input powered devices like (i) Razors, flashlights, night-lights, smoke detectors etc. (ii) Re-chargers for battery packs used in hand power tools. *These may get damaged. Please check with the manufacturer of these types of devices for suitability.*

SECTION 1 | Safety Instructions & General Information

- Devices that use radio frequency signals carried by the AC distribution wiring.
- Some new furnaces with microprocessor control / Oil burner primary controls.
- High intensity discharge (HID) lamps like Metal Halide lamps. *These may get damaged. Please check with the manufacturer of these types of devices for suitability.*
- Some fluorescent lamps / light fixtures that have power factor correction capacitors. *The inverter may shut down indicating overload.*
- Induction Cooktops.

1.3.3 Power Rating Of Inverters

The Continuous Output Power rating of an inverter is normally specified in Active Power in Watts for resistive types of loads like heating elements, incandescent lamps etc. where Power Factor (PF) = 1. The Surge Power rating is specified as a multiple of the Continuous Power Rating and normally lasts for duration of 1ms to 100ms.

Non resistive / reactive loads with Power Factor < 1 like motors (PF = 0.4 to 0.8), non Power Factor corrected electronics (PF = 0.5 to 0.6) etc, will draw higher Apparent Power in Volt Amps (VA). This Apparent Power is the sum of Active Power in Watts plus Reactive Power in VAR and is = Active Power in Watts ÷ Power Factor. Thus, for such reactive loads, higher sized inverter is required based on the Apparent Power. Further, all reactive types of loads require higher inrush/ starting surge power that may last for >1 to 5 sec and subsequent lower running power. If the inverter is not sized adequately based on the type of AC load, it is likely to shut down or fail prematurely due to repeated overloading.



INFO

The manufacturers' specification for power rating of the appliances and devices indicates only the Running Power required. The Surge Power required by some specific types of devices as explained above has to be determined by actual testing or by checking with the manufacturer. This may not be possible in all cases and hence, can be guessed at best, based on some general Rules of Thumb.

Table 1.6 below lists some common loads that require high Surge Power on start up. A "Sizing Factor" has been recommended against each which is a multiplication factor to be applied to the rated Running Watt rating of the load to arrive at the Continuous Power Rating of the inverter (Multiply the running Watts of the device/ appliance by the Sizing Factor to arrive at the Continuous Power Rating of the inverter).

SECTION 1 | Safety Instructions & General Information

TABLE 1.6 INVERTER SIZING FACTOR

Type of Device or Appliance	Inverter Sizing Factor (See Note 1)
Air Conditioner / Refrigerator / Freezer (Compressor based)	5
Air Compressor	4
Sump Pump / Well Pump / Submersible Pump	3
Dishwasher / Clothes Washer	3
Microwave (where rated output power is the Cooking Power)	2
Furnace Fan	3
Industrial Motor	3
Portable Kerosene / Diesel Fuel Heater	3
Circular Saw / Bench Grinder	3
Incandescent / Halogen / Quartz Lamps	3
Laser Printer / Other Devices using Quartz Lamps for heating	4
Switch Mode Power Supplies (SMPS): no Power Factor correction	2
Photographic Strobe / Flash Lights	4 (See Note 2)

NOTES FOR TABLE 1.6:

1 Multiply the Running Active Power Rating {Watts} of the appliance by this Factor to arrive at the Continuous Power Rating of the inverter for powering this appliance.

2 For photographic strobe / flash unit, the Surge Power of the inverter should be > 4 times the Watt Sec rating of photographic strobe / flash unit.

1.3.4 Limiting Electro-Magnetic Interference

These inverters contain internal switching devices that generate conducted and radiated electromagnetic interference (EMI). The EMI is unintentional and cannot be entirely eliminated. The magnitude of EMI is, however, limited by circuit design to acceptable levels as per limits laid down in North American FCC Standard FCC Part 15(B), Class B. These limits are designed to provide reasonable protection against harmful interference when the equipment is operated *in a residential environment*. These inverters can conduct and radiate radio frequency energy and, if not installed and used in accordance with the instruction manual, may cause harmful interference to radio communications. The effects of EMI will also depend upon a number of factors external to the inverter like proximity of the inverter to the EMI receptors, types and quality of connecting wires and cables etc. EMI due to factors external to the inverter may be reduced as follows:

- Ensure that the inverter is firmly grounded to the Ground System of the building or the vehicle.
- Locate the inverter as far away from the EMI receptors like radio, audio and video devices as possible.
- Keep the DC side wires between the battery and the inverter as short as possible.
- Do NOT keep the battery wires far apart. Keep them taped together to reduce their inductance and induced voltages. This reduces ripple in the battery wires and improves performance and efficiency.

SECTION 1 | Safety Instructions & General Information

- Shield the DC side wires with metal sheathing / copper foil / braiding.
- Use coaxial shielded cable for all antenna inputs (instead of 300 ohm twin leads).
- Use high quality shielded cables to attach audio and video devices to one another.
- Limit operation of other high power loads when operating audio / video equipment.

1.3.5 Powering Switch Mode Power Supplies

Switch Mode Power Supplies (SMPS) are extensively used to convert the incoming AC power into various voltages like 3.3V, 5V, 12V, 24V etc. that are used to power various devices and circuits used in electronic equipment like battery chargers, computers, audio and video devices, radios etc. These power supplies use large capacitors in their input section for filtration. When the power supply is first turned on, there is a very large inrush current drawn by the power supply as the input capacitors are charged (The capacitors act almost like a short circuit at the instant the power is turned on). The inrush current at turn-on is several to tens of times larger than the rated RMS input current and lasts for a few milliseconds. An example of the input voltage versus input current waveforms is given in Fig. 1.2. It will be seen that the initial input current pulse just after turn-on is > 15 times larger than the steady state RMS current. The inrush dissipates in around 2 or 3 cycles i.e. in around 33 to 50 milliseconds for 60 Hz sine wave.

Further, due to the presence of high value of input filter capacitors, the current drawn by an SMPS (With no Power Factor correction) is not sinusoidal but non-linear as shown in Fig 1.3. The steady state input current of SMPS is a train of non-linear pulses instead of a sinusoidal wave. These pulses are two to four milliseconds duration each with a very high Crest Factor corresponding to peak values around 3 times the RMS value of the input current. Crest Factor is defined by the following equation: **CREST FACTOR = PEAK VALUE ÷ RMS VALUE**

Many SMPS units incorporate "Inrush Current Limiting". The most common method is the NTC (Negative Temperature Coefficient) resistor. The NTC resistor has a high resistance when cold and a low resistance when hot. The NTC resistor is placed in series with the input to the power supply. The higher cold resistance limits the input current as the input capacitors charge up. The input current heats up the NTC and the resistance drops during normal operation. However, if the power supply is quickly turned OFF and back ON, the NTC resistor will be hot so its low resistance state will not prevent an inrush current event.

The inverter should, therefore, be sized adequately to withstand the high inrush current and the high Crest Factor of the current drawn by the SMPS. **Hence, it is recommended that for purposes of sizing the inverter, the continuous power of the inverter should be > 2 times the continuous rated power of the SMPS. For example, an SMPS rated at 100 Watts should be powered from an inverter that has continuous power of > 200 Watts.**

SECTION 1 | Safety Instructions & General Information

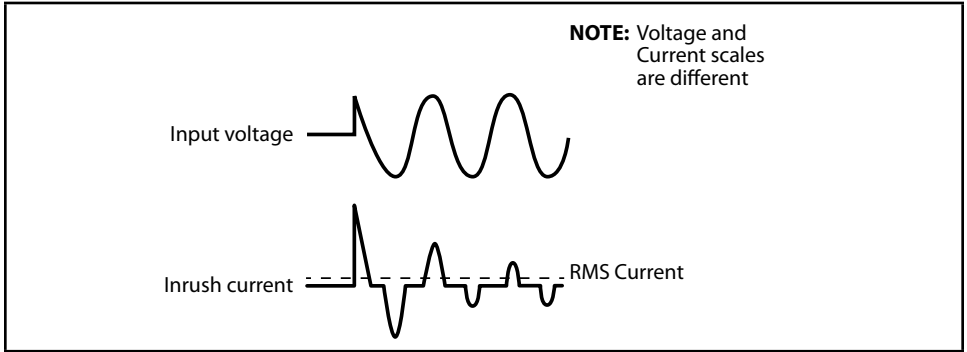

Fig 1.2 Inrush current in an SMPS

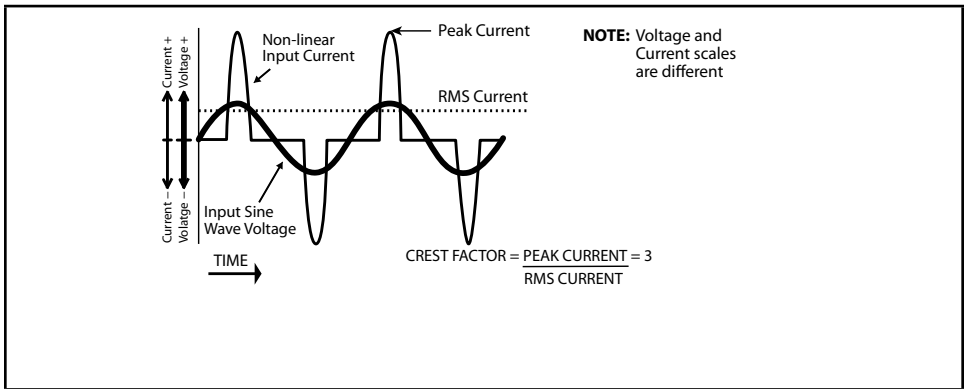

Fig 1.3 High Crest Factor of current drawn by SMPS

1.4 GENERAL INFORMATION - LEAD ACID BATTERIES



INFO

For complete background information on Lead Acid Batteries and Charging Process, visit www.samlexamerica.com>Support>White Papers>Whitepaper - Batteries, Chargers and Alternators.

Lead-acid batteries can be categorized by the type of application:

1. Automotive service - Starting/Lighting/Ignition (SLI, a.k.a. cranking), and
2. Deep cycle service.

Deep Cycle Lead Acid Batteries of appropriate capacity are recommended for powering of inverters.

SECTION 1 | Safety Instructions & General Information

1.4.1 Deep Cycle Lead Acid Batteries

Deep cycle batteries are designed with thick-plate electrodes to serve as primary power sources, to have a constant discharge rate, to have the capability to be deeply discharged to up to 80 % capacity and to repeatedly accept recharging. They are marketed for use in recreation vehicles (RV), boats and electric golf carts – so they may be referred to as RV batteries, marine batteries or golf cart batteries. Use Deep Cycle batteries for powering inverters.

1.4.2 Rated Capacity Specified in Ampere-hour (Ah)

Battery capacity “C” is specified in Ampere-hours (Ah). An Ampere is the unit of measurement for electrical current and is defined as a Coulomb of charge passing through an electrical conductor in one second. The Capacity “C” in Ah relates to the ability of the battery to provide a constant specified value of discharge current (also called “C-Rate” - see page 17) over a specified time in hours before the battery reaches a specified discharged terminal voltage (Also called “End Point Voltage”) at a specified temperature of the electrolyte. As a benchmark, the automotive battery industry rates batteries at a discharge current or C-Rate of C/20 Amperes corresponding to 20 Hour discharge period. The rated capacity “C” in Ah in this case will be the number of Amperes of current the battery can deliver for 20 Hours at 80°F (26.7°C) till the voltage drops to 1.75V / Cell. i.e. 10.5V for 12V battery or 21V for 24V battery. For example, a 100 Ah battery will deliver 5A for 20 Hours.

1.4.3 Rated Capacity Specified in Reserve Capacity (RC)

Battery capacity may also be expressed as Reserve Capacity (RC) in minutes typically for automotive SLI (Starting, Lighting and Ignition) batteries. It is the time in minutes a vehicle can be driven after the charging system fails. This is roughly equivalent to the conditions after the alternator fails while the vehicle is being driven at night with the headlights on. The battery alone must supply current to the headlights and the computer/ignition system. The assumed battery load is a constant discharge current of 25A.

Reserve capacity is the time in minutes for which the battery can deliver 25 Amperes at 80°F (26.7°C) till the voltage drops to 1.75V / Cell i.e. 10.5V for 12V battery or 21V for 24V battery.

Approximate relationship between the two units is: **Capacity “C” in Ah = Reserve Capacity in RC minutes x 0.6**

1.4.4 Typical Battery Sizes

Table 1.7 below shows details of some popular battery sizes:

BCI* Group	Battery Voltage, V	Battery Capacity, Ah
27 / 31	12	105
4D	12	160
8D	12	225
GC2**	6	220

* Battery Council International; ** Golf Cart

SECTION 1 | Safety Instructions & General Information

1.4.5 Specifying Charging / Discharging Currents: C-Rate

Electrical energy is stored in a cell / battery in the form of DC power. The value of the stored energy is related to the amount of the active materials pasted on the battery plates, the surface area of the plates and the amount of electrolyte covering the plates. As explained above, the amount of stored electrical energy is also called the Capacity of the battery and is designated by the symbol "C".

The time in Hours over which the battery is discharged to the "End Point Voltage" for purposes of specifying Ah capacity depends upon the type of application. Let us denote this discharge time in hours by "T". Let us denote the rate of discharge current of the battery as a multiple of Ah capacity "C" and call it as the "C-Rate". If the battery delivers a very high discharge current, the battery will be discharged to the "End Point Voltage" in a shorter period of time. On the other hand, if the battery delivers a lower discharge current, the battery will be discharged to the "End Point Voltage" after a longer period of time. Mathematically, C-Rate is defined as:
"C-RATE" = CAPACITY "C" in Ah ÷ DISCHARGE TIME "T"

Table 1.8 below gives some examples of C-Rate specifications and applications:

Hours of discharge time "T" till the "End Point Voltage"	"C-Rate" Discharge Current in Amps = Capacity "C" in Ah ÷ Discharge Time "T" in Hrs.	Example of C-Rate Discharge Currents for 100 Ah battery
0.5 Hrs.	2C	200A
1 Hrs.	1C	100A
5 Hrs. (Inverter application)	C/5 or 0.2C	20A
8 Hrs. (UPS application)	C/8 or 0.125C	12.5A
10 Hrs. (Telecom application)	C/10 or 0.1C	10A
20 Hrs. (Automotive application)	C/20 or 0.05C	5A
100 Hrs.	C/100 or 0.01C	1A

NOTE: When a battery is discharged over a shorter time, its specified "C-Rate" will be higher. For example, the "C-Rate" at 5 Hour discharge period i.e. C/5 Amps will be 4 times higher than the "C-Rate" at 20 Hour discharge period i.e. C/20 Amps.

1.4.6 Charging / Discharging Curves

Fig. 1.4 shows the charging and discharging characteristics of a typical 12V / 24V Flooded Lead Acid battery at electrolyte temperature of 80°F / 26.7°C. The curves show the % State of Charge (X-axis) versus terminal voltage (Y-axis) during charging and discharging at different C-Rates. **Please note that X-axis shows % State of Charge. State of Discharge will be = 100% - % State of Charge.** These curves will be referred to in the subsequent explanations.

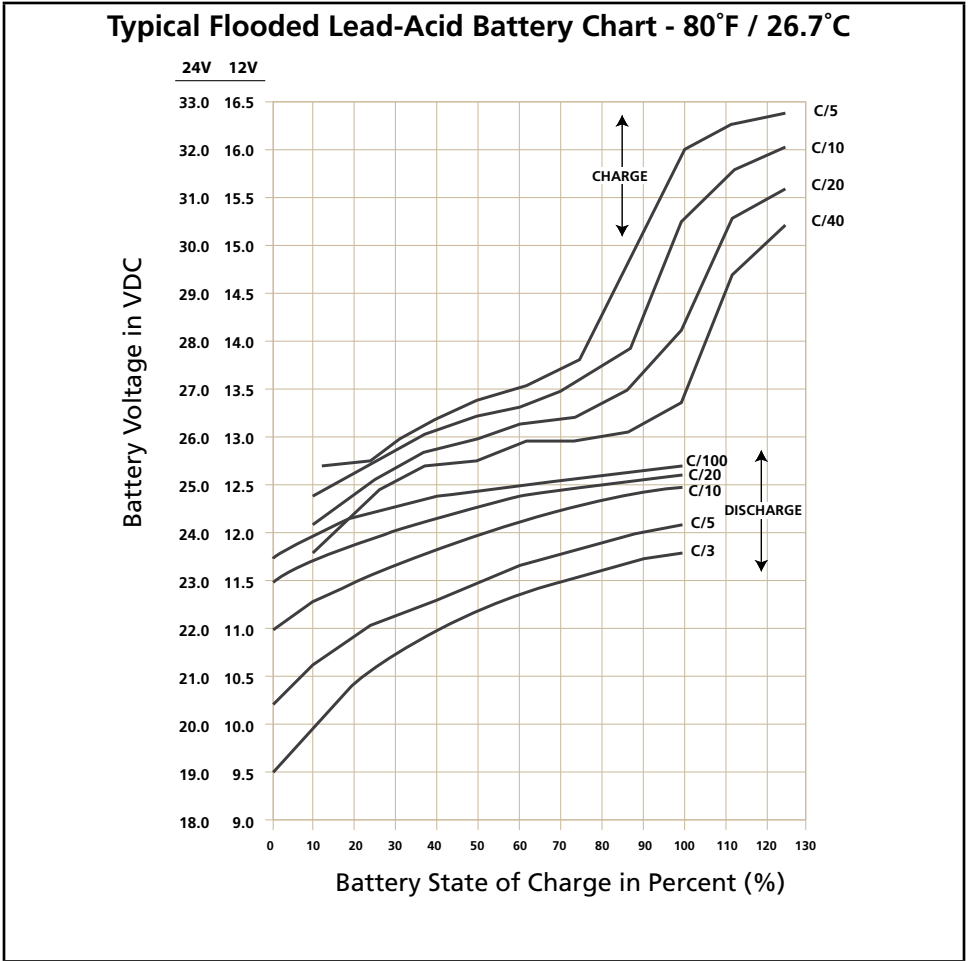

Fig 1.4 Charging / Discharging Curves for Typical Flooded Lead Acid Battery

1.4.7 Reduction in Usable Capacity at Higher Discharge Rates – Typical in Inverter Application

As stated earlier, the Ah capacity of automotive battery is normally applicable at a discharge rate of 20 Hours. As the discharge rate is increased as in cases where the inverters are driving higher capacity loads, the usable Ah capacity reduces due to "Peukert Effect". This relationship is not linear but is more or less according to the Table 1.9.

SECTION 1 | Safety Instructions & General Information

C-Rate Discharge Current	Usable Capacity (%)
C/20	100%
C/10	87%
C/8	83%
C/6	75%
C/5	70%
C/3	60%
C/2	50%
1C	40%

Table 1.9 shows that a 100 Ah capacity battery will deliver 100% (i.e. full 100 Ah) capacity if it is slowly discharged over 20 Hours at the rate of 5 Amperes (50W output for a 12V inverter and 100W output for a 24V inverter). However, if it is discharged at a rate of 50 Amperes (500W output for a 12V inverter and 1000W output for a 24V inverter) then theoretically, it should provide $100 \text{ Ah} \div 50 = 2$ Hours. However, Table 1.9 above shows that for 2 Hours discharge rate, the capacity is reduced to 50% i.e. 50 Ah. Therefore, at 50 Ampere discharge rate (500W output for a 12V inverter and 1000W output for a 24V inverter) the battery will actually last for $50 \text{ Ah} \div 50 \text{ Amperes} = 1$ Hour.

1.4.8 State of Charge (SOC) of a Battery – Based on “Standing Voltage”

The “Standing Voltage” of a battery under open circuit conditions (no load connected to it) can approximately indicate the State of Charge (SOC) of the battery. **The “Standing Voltage” is measured after disconnecting any charging device(s) and the battery load(s) and letting the battery “stand” idle for 3 to 8 hours before the voltage measurement is taken.** Table 1.10 below shows the State of Charge versus Standing Voltage for a typical 12V/24V battery system at 80°F (26.7°C).

Percentage of Full Charge	Standing Voltage of Individual Cells	Standing Voltage of 12V Battery	Standing Voltage of 24V Battery
100%	2.105V	12.63V	25.26V
90%	2.10V	12.6V	25.20V
80%	2.08V	12.5V	25.00V
70%	2.05V	12.3V	24.60V
60%	2.03V	12.2V	24.40V
50%	2.02V	12.1V	24.20V
40%	2.00V	12.0V	24.00V
30%	1.97V	11.8V	23.60V
20%	1.95V	11.7V	23.40V
10%	1.93V	11.6V	23.20V
0%	= / < 1.93V	= / < 11.6V	= / < 23.20V

SECTION 1 | Safety Instructions & General Information

Check the individual cell voltages / specific gravity. If the inter-cell voltage difference is more than a 0.2V, or the specific gravity difference is 0.015 or more, the cells will require equalization.

Please note that only non-sealed / vented / flooded / wet cell batteries are equalized. Do not equalize sealed / VRLA type of AGM or Gel Cell Batteries.

1.4.9 State of Discharge of a Loaded Battery – Low Battery / DC Input Voltage Alarm and Shutdown in Inverters

Most inverter hardware estimate the State of Discharge of the loaded battery by measuring the voltage at the inverter's DC input terminals (considering that the DC input cables are thick enough to allow a negligible voltage drop between the battery and the inverter).

Inverters are provided with a buzzer alarm to warn that the loaded battery has been deeply discharged to around 80% of the rated capacity. **Normally, the buzzer alarm is triggered when the voltage at the DC input terminals of the inverter has dropped to around 10.5V for a 12V battery or 21V for 24V battery at C-Rate discharge current of C/5 Amps and electrolyte temp. of 80°F.** The inverter is shut down if the terminal voltage at C/5 discharge current falls further to 10V for 12V battery or 20V for 24V battery.

The State of Discharge of a battery is estimated based on the measured terminal voltage of the battery. The terminal voltage of the battery is dependent upon the following:

- **Temperature of the battery electrolyte:** Temperature of the electrolyte affects the electrochemical reactions inside the battery and produces a Negative Voltage Coefficient – during charging / discharging, the terminal voltage drops with rise in temperature and rises with drop in temperature
- **The amount of discharging current or “C-Rate”:** A battery has non linear internal resistance and hence, as the discharge current increases, the battery terminal voltage decreases non-linearly

The discharge curves in Fig. 1.4 show the % State of Charge versus the terminal voltage of typical Flooded Lead Acid Battery under different charge /discharge currents, i.e. “C-Rates” and fixed temperature of 80°F. **(Please note that the X-Axis of the curves shows the % of State of Charge. The % of State of Discharge will be 100% - % State of Charge).**

1.4.10 Low DC Input Voltage Alarm in Inverters

As stated earlier, the buzzer alarm is triggered when the voltage at the DC input terminals of the inverter has dropped to around 10.5V for a 12V battery or 21V for 24V battery at C-Rate discharge current of C/5 Amps. Please note that the terminal voltage relative to a particular of State Discharge decreases with the rise in the value of the discharge current. For example, terminal voltages for a State of Discharge of 80% (State of Charge of 20%) for various discharge currents will be as given at Table 1.11 (Refer to Fig. 1.4 for parameters and values shown in Table 1.11):

SECTION 1 | Safety Instructions & General Information

Table 1.11 TERMINAL VOLTAGE AND SOC OF LOADED BATTERY

Discharge Current: C-Rate	Terminal Voltage at 80% State of Discharge (20% SOC)		Terminal Voltage When Completely Discharged (0% SOC)	
	12V	24V	12V	24V
C/3 A	10.45V	20.9V	09.50V	19.0V
C/5 A	10.90V	21.8V	10.30V	20.6V
C/10 A	11.95V	23.9V	11.00V	22.0V
C/20 A	11.85V	23.7V	11.50V	23.0V
C/100 A	12.15V	24.3V	11.75V	23.5V

In the example given above, the 10.5V / 21.0V Low Battery / DC Input Alarm would trigger at around 80% discharged state (20% SOC) when the C-Rate discharge current is C/5 Amps. However, for lower C-Rate discharge current of C/10 Amps and lower, the battery will be almost completely discharged when the alarm is sounded. **Hence, if the C-Rate discharge current is lower than C/5 Amps, the battery may have completely discharged by the time the Low DC Input Alarm is sounded.**

1.4.11 Low DC Input Voltage Shut-down In Inverters

As explained above, at around 80% State of Discharge of the battery at C-Rate discharge current of around C/5 Amps, the Low DC Input Voltage Alarm is sounded at around 10.5V for a 12V battery (at around 21V for 24V battery) to warn the user to disconnect the battery to prevent further draining of the battery. If the load is not disconnected at this stage, the batteries will be drained further to a lower voltage and to a completely discharged condition that is harmful for the battery and for the inverter.

Inverters are normally provided with a protection to shut down the output of the inverter if the DC voltage at the input terminals of the inverter drops below a threshold of around 10V for a 12V battery (20V for 24V battery). Referring to the Discharge Curves given in Fig 1.4, the State of Discharge for various C-Rate discharge currents for battery voltage of 10V / 20V is as follows: (Please note that the X-Axis of the curves shows the % of State of Charge. The % of State of Discharge will be 100% - % State of Charge):

- 85% State of Discharge (15% State of Charge) at very high C-rate discharge current of C/3 Amps.
- 100% State of Discharge (0 % State of Charge) at high C-Rate discharge current of C/5 Amps.
- 100% discharged (0% State of charge) at lower C-rate Discharge current of C/10 Amps.

It is seen that at DC input voltage of 10V / 20V, the battery is completely discharged for C-rate discharge current of C/5 and lower.

In view of the above, it may be seen that a fixed Low DC Input Voltage Alarm is not useful. Temperature of the battery further complicates the situation. All the above analysis is based on battery electrolyte temperature of 80°F. The battery capacity varies with temperature. Battery capacity is also a function of age and charging history. Older batteries have lower capacity because of shedding of active materials, sulfation, corrosion, increasing number of charge / discharge cycles etc. Hence, the State of Discharge of a battery under load cannot be estimated accurately. However, the low DC input voltage alarm and shut-down function are designed to protect the inverter from excessive current drawn at the lower voltage.

SECTION 1 | Safety Instructions & General Information

1.4.12 Depth of Discharge of Battery and Battery Life

The more deeply a battery is discharged on each cycle, the shorter the battery life. Using more batteries than the minimum required will result in longer life for the battery bank. A typical cycle life chart is given in the Table 1.12 below:

Depth of Discharge % of Ah Capacity	Cycle Life of Group 27 /31	Cycle Life of Group 8D	Cycle Life of Group GC2
10	1000	1500	3800
50	320	480	1100
80	200	300	675
100	150	225	550

NOTE: It is recommended that the depth of discharge should be limited to 50%.

1.4.13 Series and Parallel Connection of Batteries

Refer to details at Section 3.4.

1.4.14 Sizing the Inverter Battery Bank

One of the most frequently asked questions is, “how long will the batteries last?” This question cannot be answered without knowing the size of the battery system and the load on the inverter. Usually this question is turned around to ask “How long do you want your load to run?”, and then specific calculation can be done to determine the proper battery bank size. There are a few basic formulae and estimation rules that are used:

1. Active Power in Watts (W) = Voltage in Volts (V) x Current in Amperes (A) x Power Factor
2. For an inverter running from a 12V battery system, the DC current required from the 12V batteries is the AC power delivered by the inverter to the load in Watts (W) divided by 10 & for an inverter running from a 24V battery system, the DC current required from the 24V batteries is the AC power delivered by the inverter to the load in Watts (W) divided by 20.
3. Energy required from the battery = DC current to be delivered (A) x Time in Hours (H).

The first step is to estimate the total AC watts (W) of load(s) and for how long the load(s) will operate in hours (H). The AC watts are normally indicated in the electrical nameplate for each appliance or equipment. In case AC watts (W) are not indicated, Formula 1 given above may be used to calculate the AC watts. The next step is to estimate the DC current in Amperes (A) from the AC watts as per Formula 2 above. An example of this calculation for a 12V inverter is given below:

Let us say that the total AC Watts delivered by the inverter = 1000W.

Then, using Formula 2 above, the DC current to be delivered by the 12V batteries = $1000W \div 10 = 100$ Amperes, or by 24V batteries = $1000W \div 20 = 50A$.

Next, the energy required by the load in Ampere Hours (Ah) is determined.

For example, if the load is to operate for 3 hours then as per Formula 3 above, the energy to be delivered by the 12V batteries = 100 Amperes x 3 Hours = 300 Ampere Hours (Ah), or by the 24V batteries = $50A$ x 3 Hrs = 150 Ah.

SECTION 1 | Safety Instructions & General Information

Now, the capacity of the batteries is determined based on the run time and the usable capacity.

From Table 1.9 "Battery Capacity versus Rate of Discharge", the usable capacity at 3 Hour discharge rate is 60%. Hence, the actual capacity of the 12V batteries to deliver 300 Ah will be equal to: $300 \text{ Ah} \div 0.6 = 500 \text{ Ah}$, and the actual capacity of the 24V battery to deliver 150 Ah will be equal to $150 \text{ Ah} \div 0.6 = 250 \text{ Ah}$.

And finally, the actual desired rated capacity of the batteries is determined based on the fact that normally only 80% of the capacity will be available with respect to the rated capacity due to non availability of ideal and optimum operating and charging conditions. So the final requirements will be equal to:

FOR 12V BATTERY: $500 \text{ Ah} \div 0.8 = 625 \text{ Ah}$ (note that the actual energy required by the load was 300 Ah).

FOR 24V BATTERY: $250 \text{ Ah} \div 0.8 = 312.5 \text{ Ah}$ (Note that the actual energy required was 150 Ah).

It will be seen from the above that the final rated capacity of the batteries is almost 2 times the energy required by the load in Ah. ***Thus, as a Rule of Thumb, the Ah capacity of the batteries should be twice the energy required by the load in Ah.***

1.14.15 Charging Batteries

Batteries can be charged by using good quality AC powered battery charger or from alternative energy sources like solar panels, wind or hydro systems. Make sure an appropriate Battery Charge Controller is used. It is recommended that batteries may be charged at 10% to 20% of their Ah capacity (Ah capacity based on 20 Hr Discharge Rate). Also, for complete charging (return of 100% capacity), it is recommended that a 3 Stage Charger may be used (Constant Current Bulk Charging followed by Constant Voltage Boost / Absorption Charging followed by Constant Voltage Float Charging).

SECTION 2 | Components & Layout

2.1 MAIN UNIT: LAYOUT-FRONT (FIG 2.1)

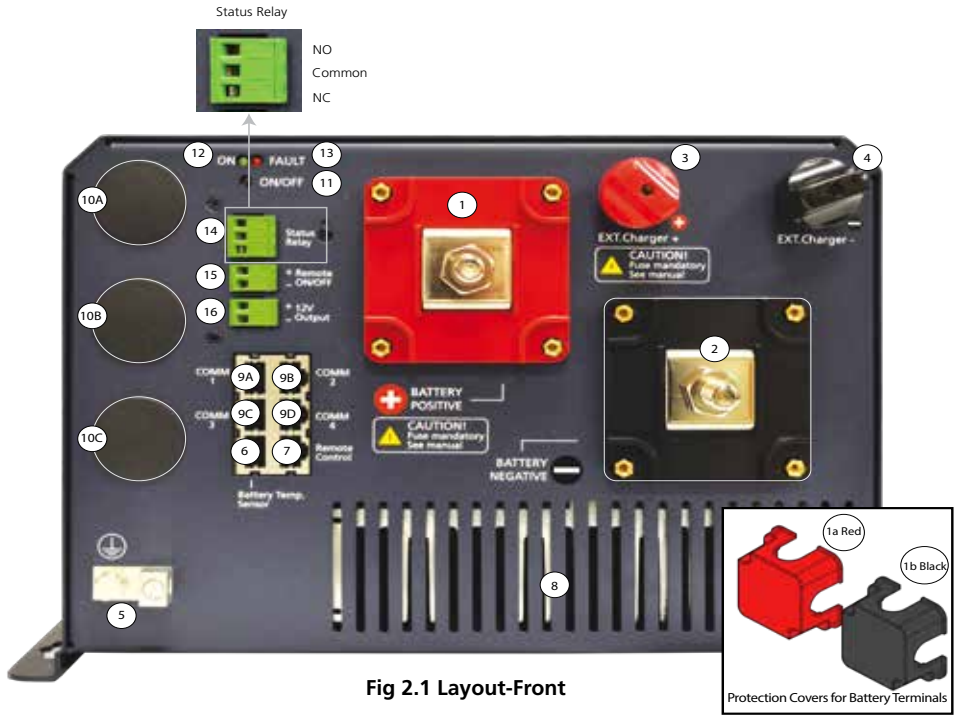

Fig 2.1 Layout-Front

1. Battery Positive (+) Input Connector – M10 x 1.25 Nut & Bolt (RED Protection Cover 1(a) is Removed)
 - 1a. RED Protection Cover For Battery Positive (+) Input Connector
2. Battery Negative (-) Input Connector – M10 x 1.25 Nut & Bolt (Black Protection Cover 1(b) is Removed)
 - 2a. Black Protection Cover for Battery Negative (-) Input Connector
3. External Charger (+) Input Connector – M12 x 0.75 Thumb Nut and Bolt
4. External Charger (-) Input Connector - M12 x 0.75 Thumb Nut and Bolt
5. DC Side Ground Connector – Hole Dia 6.5mm for AWG #4 to #6. Set Screw M-8
6. RJ-45 Jack for Temperature Sensor "EVO-BCTS" (Fig. 2.5)
7. RJ-45 Jack for EVO-RC Remote
8. Air inlet vents for 2 internal cooling fans [Additional air inlet vents at the bottom (not shown)]
- 9A, 9B. RJ-45 Jacks for Communication Ports "COMM 1" and "COMM 2" - For RS-485 networking and MODBUS Serial Communication Protocol (for future use)
- 9C, 9D. RJ-45 Jacks for Communication Ports "COM 3" and "COM 4" - For "CANbus" Serial Communication Protocol (for future use)
- 10A to 10C. Knock outs for AC wiring inlet/exit wiring entry (Diameter: 27.8mm / 1 3/32") (For 3/4" conduit/fittings)
11. ON/OFF Push Button
12. Green LED "ON"
13. Red LED "Fault"
14. Output Terminals for Status Relay - Screw M 2.5; AWG #30 to #12
 - NO (Normally Open)
 - Common
 - NC (Normally Closed)

SECTION 2 | Components & Layout

15. +12V Input Terminals for "Remote On Off" (9 to 15V, 3mA) - Screw M 2.5; AWG #30 to #12
16. Output Terminals for +12VDC source (up to 100mA) (available only when unit is ON) - Screw M 2.5; AWG #30 to #12

2.2 MAIN UNIT: LAYOUT-BACK (FIG 2.2)

1. Air outlet vents for 2 internal fans

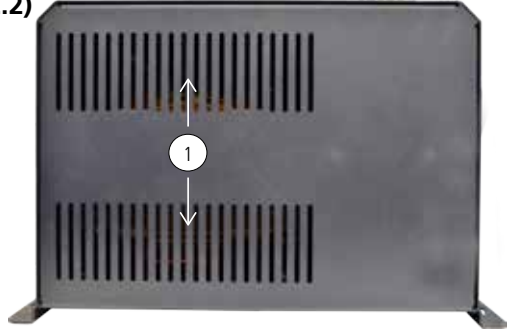

Fig 2.2 Layout-Back

2.3 MAIN UNIT: LAYOUT-AC SIDE (FIG 2.3)

1. Cover plate for pocket for AC Input/Output terminals
2. Pocket for AC Input/Output Terminals (behind cover plate 1)
3. AC Input/Output Terminal Block
 - Terminal hole diameter: 6mm for up to AWG #6
 - Set Screw: M4
4. Grid Input - Line
5. Grid Input - Ground
6. Grid Input - Neutral
7. Generator Input - Line
8. Generator Input - Ground
9. Generator Input - Neutral
10. AC Output - Line
11. AC Output - Ground
12. AC Output - Neutral
13. Male/Female Insulated Quick Disconnect for disabling Output Neutral to Chassis Ground bond in Inverter Mode (Please see Sections 4.5.1 to 4.5.3 and Fig 3.12)

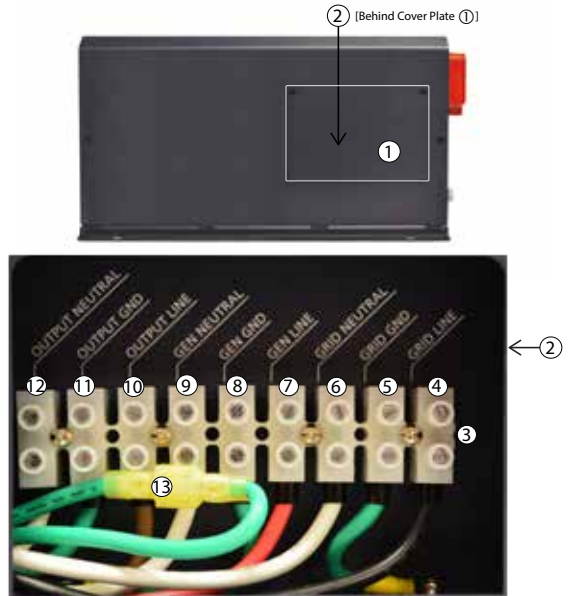

Fig 2.3 Layout-AC Side

SECTION 2 | Components & Layout

2.4 REMOTE CONTROL EVO-RC (FIG 2.4) [OPTIONAL]

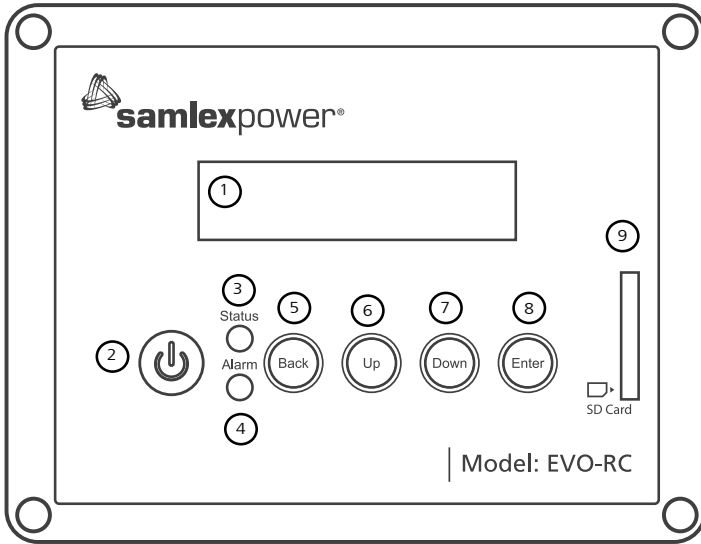

Fig 2.4(a) Optional Remote Control EVO-RC

1. LCD Screen - 2 rows of 16 characters each
2. ON/OFF Key
3. Green LED "Status"
4. Red LED "Alarm" (Fault)
5. Navigation Key "Back"
6. Navigation Key "Up"
7. Navigation Key "Down"
8. Navigation Key "Enter"
9. SD Card Slot - FAT16/32 format; Up to 16GB
10. RJ-45 Jack (At the back-not shown)
11. RJ-45 Data Cable (Straight Wired), 10 meter/33 feet length {Fig 2.4(b)}



Fig 2.4(b) Cable for Remote Control

SECTION 2 | Components & Layout

2.5 BATTERY TEMPERATURE SENSOR EVO-BCTS [FIG 2.5 (a)]

1. Temperature Sensor: Mounting hole: 10mm/0.39" suitable for 3/8" or 5/16" battery studs
2. RJ-45 Plug
3. 5 meter/16.5 ft cable

Note: Mount the sensor on the Positive or Negative terminal stud on the battery as shown in Fig 2.5(b)



Fig 2.5(a) Temperature Sensor Model EVO-BCTS



Fig 2.5(b) Temperature Sensor Installation

2.6 CONTENTS OF PACKAGE

Inverter Charger

Temperature Sensor EVO-BCTS [Fig 2.5(a)]

DC Terminal Covers (1a, 1b: Fig 2.1) (Fitted on the unit with 2 screws each)

Mating Connectors (14, 15, 16: Fig 2.1)

Wire End Terminals for AC Wiring (Fig 3.11)

Model	AWG#10	AW #8	AWG#6
EVO-2212 and EVO-2224	3	6	-
EVO-3012 and EVO-4024	-	9	6

Owner's Manual

Quick Start Guide

SECTION 3 | Installation

3.1 SAFETY OF INSTALLATION



WARNING!

Please ensure safety instructions given under Section 1 are strictly followed.



ATTENTION!

Se il vous plaît assurer consignes de sécurité fournies à la section 1 sont strictement suivies.

3.2 OVERALL DIMENSIONS

The overall dimensions and the location of the mounting holes are shown in Fig. 3.1.

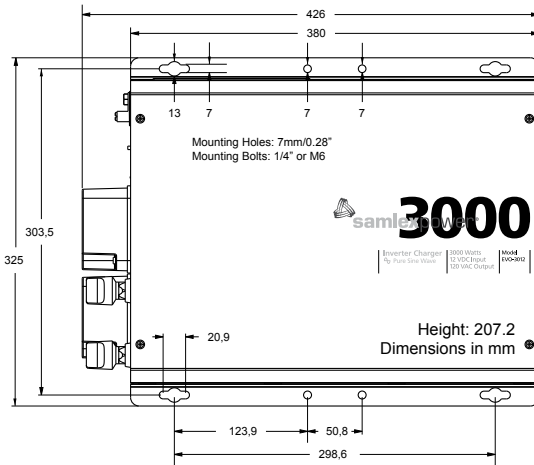

Fig. 3.1 Mounting Dimensions

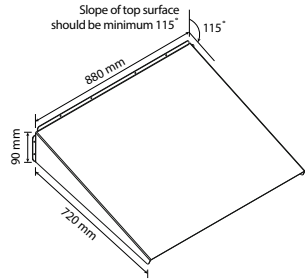

Fig. 3.1(a) Dimensions of Drip Shield

3.3 MOUNTING OF THE UNIT

In order to meet the regulatory safety requirements, the mounting has to satisfy the following requirements:

- Mount on a non-combustible material
- The mounting surface should be able to support a weight of at least 60 Kg / 132 lbs. Use 4 pcs of 1/4" or M6 mounting bolts and lock washers
- Installation on marine craft and vessels will require use of Drip Shield on top of the unit to protect against ingress of water dripping from top. Drawing of Drip Shield is given at Fig 3.1(a). Configurations using the Drip Shield are shown under "Mounting Orientation".

Cooling: The unit has openings on the front, bottom and back for cooling and ventilation. Ensure that these openings are not blocked or restricted. Install in cool, dry and well ventilated area.

SECTION 3 | Installation

CAUTION! Ensure there is **OVER 200 mm** clear space surrounding the inverter for ventilation.

ATTENTION! Assurer qu'il y a **PLUS QUE 200 mm** d'espace DÉGAGÉ entourant l'onduleur pour faciliter la ventilation.

Mounting Orientation:

- Mount horizontally on a horizontal surface (e.g. table top or a shelf). Please see Fig. 3.2.

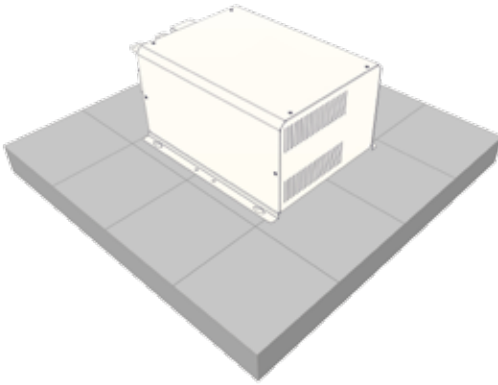

(a) Non Marine Installation

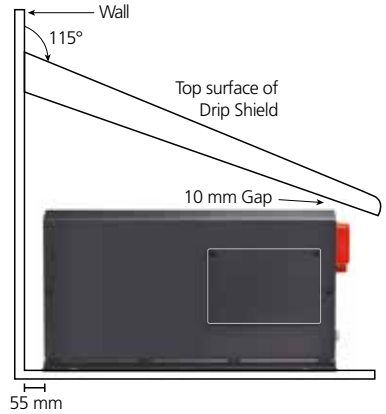

(b) Marine Installation

Fig 3.2 Mounting Arrangement: Horizontally On Horizontal Surface

- Mount horizontally on a vertical surface (like a wall) with the fan axis horizontal and the DC input terminals facing left. Please see Fig. 3.3.

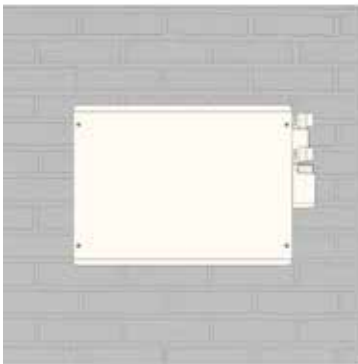

(a) Non Marine Installation

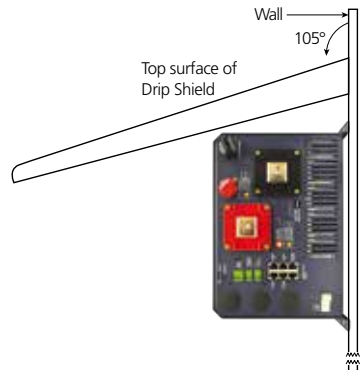

(b) Marine Installation

Fig 3.3 Mounting Arrangement 1: On Vertical Surface

SECTION 3 | Installation

- Mount vertically on a vertical surface, see Fig. 3.4. Protect against possibility of small objects or water entering the ventilation openings on the top. (If necessary, install a suitable sloping guard at least 200mm from the top surface). Also, ensure there is no combustible material directly under the unit.



(a) Non Marine Installation

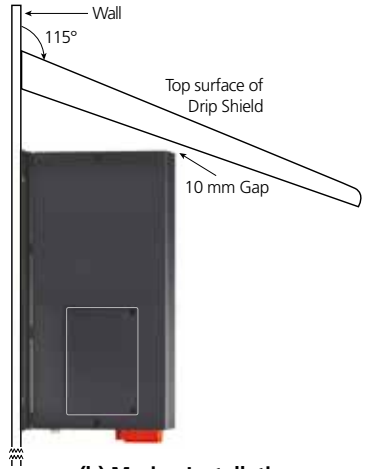

(b) Marine Installation

Fig 3.4 Mounting Arrangement 2: On Vertical Surface

3.4 INSTALLING BATTERIES - SERIES AND PARALLEL CONNECTION

Batteries are normally available in voltages of 2V, 6V and 12V and with different Ah capacities. A number of individual batteries can be connected in series and in parallel to form a bank of batteries with the desired increased voltage and capacity.

3.4.1 Series

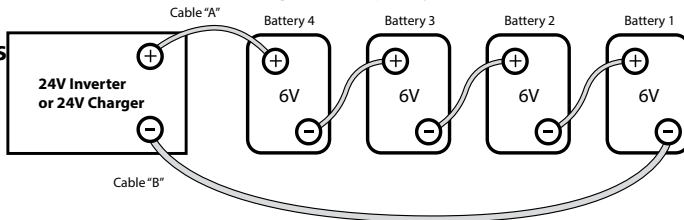

Fig 3.5 Series Connection

When two or more batteries are connected in series, their voltages add up but their Ah capacity remains the same. Fig. 3.5 shows 4 pieces of 6V, 200 Ah batteries connected in series to form a battery bank of 24V with a capacity of 200 Ah. The Positive terminal of battery 4 becomes the Positive terminal of the 24V bank. The Negative terminal of battery 4 is connected to the Positive terminal of battery 3. The Negative terminal of battery 3 is connected to the Positive terminal of battery 2. The Negative terminal of battery 2 is connected to the Positive terminal of battery 1. The Negative terminal of battery 1 becomes the Negative terminal of the 24V battery bank.

SECTION 3 | Installation

3.4.2 Parallel Connection

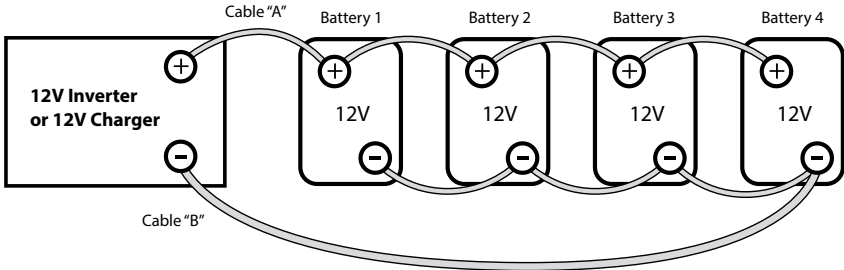

Fig 3.6 Parallel Connection

When two or more batteries are connected in parallel, their voltage remains the same but their Ah capacities add up. Fig. 3.6 above shows 4 pieces of 12V, 100 Ah batteries connected in parallel to form a battery bank of 12V with a capacity of 400 Ah. The four Positive terminals of batteries 1 to 4 are paralleled (connected together) and this common Positive connection becomes the Positive terminal of the 12V bank. Similarly, the four Negative terminals of batteries 1 to 4 are paralleled (connected together) and this common Negative connection becomes the Negative terminal of the 12V battery bank.

3.4.3 Series – Parallel Connection

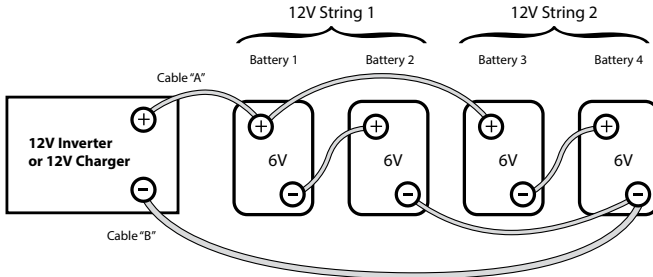

Fig. 3.7 Series-Parallel Connection

Figure 3.7 shows a series – parallel connection consisting of four 6V, 200 Ah batteries to form a 12V, 400 Ah battery bank. Two 6V, 200 Ah batteries, Batteries 1 and 2 are connected in series to form a 12V, 200 Ah battery (String 1). Similarly, two 6V, 200 Ah batteries, Batteries 3 and 4 are connected in series to form a 12V, 200 Ah battery (String 2). These two 12V, 200 Ah Strings 1 and 2 are connected in parallel to form a 12V, 400 Ah bank.

SECTION 3 | Installation

3.4.4 Wiring Order in Parallel Connection of Batteries



CAUTION!

When 2 or more batteries / battery strings are connected in parallel and are then connected to inverter/charger (See Figs 3.6 and 3.7), attention should be paid to the manner in which the inverter/charger is connected to the battery bank. Please ensure that if the Positive output cable of the inverter/charger (Cable "A") is connected to the Positive battery post of the first battery (Battery 1 in Fig 3.6) or to the Positive battery post of the first battery string (Battery 1 of String 1 in Fig. 3.7), then the Negative output cable of the inverter/charger (Cable "B") should be connected to the Negative battery post of the last battery (Battery 4 as in Fig. 3.6) or to the Negative Post of the last battery string (Battery 4 of Battery String 2 as in Fig. 3.7). This connection ensures the following:

- The resistances of the interconnecting cables will be balanced.
- All the individual batteries / battery strings will see the same series resistance.
- All the individual batteries will charge/discharge at the same charging/discharging current and thus, will be charged/discharged to the same state at the same time.
- None of the batteries will see an overcharge/overdischarge condition.

If the Positive output cable of the inverter/charger (Cable "A") is connected to the Positive battery post of the first battery (Battery 1 in Fig. 3.6) or to the Positive battery post of the first battery string (Battery 1 of String 1 in Fig. 3.7), and the Negative output cable of the inverter/charger (Cable "B") is connected to the Negative battery post of the first battery (Battery 1 as in Fig. 3.6) or to the Negative Post of the first battery string (Battery 1 of Battery String 1 as in Fig 3.7), the following abnormal conditions will result:

- The resistances of the connecting cables will not be balanced.
- The individual batteries will see different series resistances.
- All the individual batteries will be charged/discharged at different charging/discharging current and thus, will reach fully charged/discharged state at different times.
- The battery with lower series resistance will take shorter time to charge/discharge as compared to the battery which sees higher series resistance and hence, will experience over charging/over discharging and its life will be reduced.

SECTION 3 | Installation



ATTENTION!

Quand il y a 2 batteries/fils de batterie ou plus qui sont liés en parallèle et branché à la fois, à un chargeur (Voir Figs. 3.6 et 3.7), il faut faire attention à la manière dont le chargeur est branché à la banque de batterie. Veuillez assurer que le câble positif de sortie du chargeur de batterie (Câble A) est lié à la borne positive de la première batterie (La batterie 1 dans la Fig. 3.6) ou à la borne positive de batterie qui est liée au premier fil (Le fil 1 et la batterie 1, Fig 3.7), et puis le câble négatif de sortie du chargeur de batterie (Câble B) est lié à la borne négative de la dernière batterie (La Batterie 4 dans la Fig. 3.6) ou à la borne négative de batterie qui est liée au dernier fil (Le fil 2 et La batterie 4 dans la Fig. 3.7). Cette connexion assure la suivante:

- Les résistances des câbles interconnectés seront équilibrées
- Tous les batteries/ fils de batterie dans la série auront la même résistance
- Toutes les batteries individuelles vont recharger au même courant, ainsi elles seront rechargées à l'état pareille, au même temps
- Aucune des batteries auront une condition de surcharge.

Si le câble positif de sortie du chargeur de batterie (Câble A) est lié à la borne positive de la première batterie (La batterie 1 dans la Fig. 3.6) ou à la borne positive de batterie qui est liée au premier fil (Le fil 1 et La Batterie 1, Fig 3.7), et puis le câble négatif de sortie du chargeur de batterie (Câble B) est lié à la borne négative de la première batterie (La batterie 1 dans la Fig. 3.6) ou à la borne négative de batterie qui est liée au premier fil (Le fil 1 de La Batterie 1 dans la Fig. 3.7), les conditions anormales résulteront:

- Les résistances des câbles interconnectés seront pas équilibrées
- Tous les batteries/ fils de batterie dans la série n'auront pas la même résistance
- Toutes les batteries individuelles vont recharger à des courants différentes, ainsi elles atteindront un état de rechargement complet mais en décalage.
- La batterie ayant le moins de résistance dans la série prendrait moins de temps pour être rechargée comparé aux autres batteries. Alors elle serait surchargée et, en conséquence aurait une vie plus courte.

SECTION 3 | Installation

3.5 DC SIDE CONNECTIONS

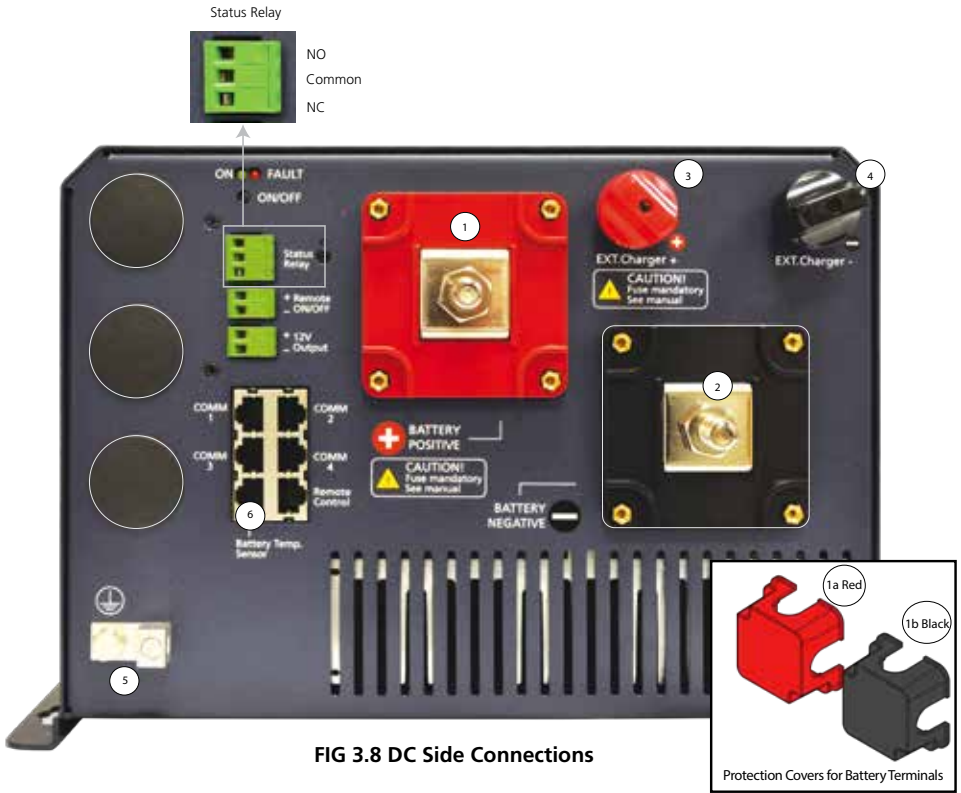

FIG 3.8 DC Side Connections

1. Battery Positive (+) Input Connector – M10 x 1.25 Nut & Bolt (RED Protection Cover 1(a) is Removed)
 - 1a. RED Protection Cover For Battery Positive (+) Input Connector
2. Battery Negative (-) Input Connector – M10 x 1.25 Nut & Bolt (Black Protection Cover 1(b) is Removed)
 - 2a. Black Protection Cover for Battery Negative (-) Input Connector
3. External Charger (+) Input Connector – M12 x 0.75 Thumb Nut and Bolt
4. External Charger (-) Input Connector - M12 x 0.75 Thumb Nut and Bolt
5. DC Side Ground Connector – Hole Dia 6.5mm for AWG #4 to #6. Set Screw M-8
6. RJ-45 Jack for Battery Temperature Sensor EVO-BCTS

The following DC side connections are required to be made (see Fig 3.8):

- Deep cycle batteries are connected to the battery input terminals (1) and (2). The terminals are provided with protective covers – RED for Positive and BLACK for Negative. Fit these covers once connections have been made. For details on sizing and charging of batteries, please refer to Section 1.4 under "General Information-Lead Acid Batteries".
- Use appropriate external fuse (Refer to Table 3.1) within 7" of battery Positive terminal.

SECTION 3 | Installation

- External charging source, if any, is connected to the connectors (3) and (4) as shown above. **The maximum capacity of the external charging source is 50A.**
- Battery Temperature Sensor EVO-BCTS is connected to the RJ-45 Jack (6). See Fig 2.5 (a) and 2.5 (b) for details.

3.5.1 Preventing DC Input Over Voltage

It is to be ensured that the DC input voltage of this unit does not exceed 17 VDC for the 12V battery version EVO-2212 and EVO-3012, and 35 VDC for the 24V battery versions EVO-2224 and EVO-4024 to prevent permanent damage to the unit.

3.5.2 Preventing Reverse Polarity On The Input Side



CAUTION!

When making battery connections on the input side, make sure that the polarity of battery connections is correct (Connect the Positive of the battery to the Positive terminal of the unit and the Negative of the battery to the Negative terminal of the unit). If the input is connected in reverse polarity, external DC fuse in the input side will blow and may also cause permanent damage to the inverter.

Damage caused by reverse polarity is not covered by warranty.

3.5.3 Connection From Batteries / External Charge Controller To The DC Input Side – Sizing of Cables And Fuses



WARNING!

The input section of the inverter has large value capacitors connected across the input terminals. As soon as the DC input connection loop (Battery (+) terminal → Fuse → Positive input terminal of EVO → Negative input terminal of the EVO → Battery (-) terminal) is completed, these capacitors will start charging and the unit will momentarily draw very heavy current that will produce sparking on the last contact in the input loop even when the unit is in powered down condition.

Ensure that the fuse is inserted only after all the connections in the loop have been completed so that sparking is limited to the fuse area.

Flow of electric current in a conductor is opposed by the resistance of the conductor. The resistance of the conductor is directly proportional to the length of the conductor and inversely proportional to its cross-section (thickness). The resistance in the conductor produces undesirable effects of voltage drop and heating. The size (thickness / cross-section) of the conductors is designated by AWG (American Wire Gauge). Conductors thicker than AWG #4/0 are sized in MCM/kcmil.

Conductors are protected with insulating material rated for specific temperature e.g. 90°C/194°F. As current flow produces heat that affects insulation, there is a maximum permissible value of current (called "Ampacity") for each size of conductor based on temperature rating of its insulation. The insulating material of the cables will also be affected by the elevated operating temperature of the terminals to which these are connected. Ampacity of cables is based on UL-1741 and the National Electrical Code (NEC)-2014. Please see details given under "Notes for Table 3.1".

SECTION 3 | Installation

The DC input circuit is required to handle very large DC currents and hence, the size of the cables and connectors should be selected to ensure minimum voltage drop between the battery and the inverter. Thinner cables and loose connections will result in poor inverter performance and will produce abnormal heating leading to risk of insulation melt down and fire. Normally, the thickness of the cable should be such that the voltage drop due to the current & the resistance of the length of the cable should be less than 2%. Use oil resistant, multi-stranded copper wire cables rated at 90° C minimum. Do not use aluminum cable as it has higher resistance per unit length. Cables can be bought at a marine / welding supply store.

Effects of low voltage on common electrical loads are given below:

- **Lighting circuits - incandescent and Quartz Halogen:** A 5% voltage drop causes an approximate 10% loss in light output. This is because the bulb not only receives less power, but the cooler filament drops from white-hot towards red-hot, emitting much less visible light.
- **Lighting circuits - fluorescent:** Voltage drop causes a nearly proportional drop in light output.
- **AC induction motors** - These are commonly found in power tools, appliances, well pumps etc. They exhibit very high surge demands when starting. Significant voltage drop in these circuits may cause failure to start and possible motor damage.
- **PV battery charging circuits** - These are critical because voltage drop can cause a disproportionate loss of charge current to charge a battery. A voltage drop greater than 5% can reduce charge current to the battery by a much greater percentage.



ATTENTION!

Des dégâts causés par un renversement des polarités n'est pas couverts par la garantie.

Quand vous faites des connexions à la batterie du côté d'entrée, veuillez assurer que les polarités sont mise du bon côté (Lié le positif de la batterie à la borne positive de l'appareil et le négatif de la batterie à la borne négative de l'appareil. Si les polarité de l'entrée sont mise à l'envers, le fusible CC externe du côté d'entrée va s'exploser et peut causer des dégâts permanent à l'onduleur.



ATTENTION!

La section d'entrée de l'onduleur a des condensateurs de grande valeur qui sont connecté aux bornes d'entrées. Tant que le boucle de connexion d'entrée CC (la borne (+) de la batterie → le fusible la borne → d'entrée positive du EVO → la borne d'entrée négative de EVO → la borne (-) de la batterie est complet, les condasateurs commenceront à recharger. L'appareil prendra un courant fort brièvement pour s'alimenter qui va produire une étincelle sur le dernier contact du boucle d'entrée même si l'interrupteur ON/OFF du l'onduleur est dans la position OFF.

Assurez que le fusible est insérer seulement après que toutes les connexions sont faites dans le boucle pour que des étincelles se produisent seulement à l'endroit du fusible

Le flux du courant dans un conducteur est opposé par la résistance du conducteur. La résistance du conducteur est corrélative à la longueur du conducteur et inversement corrélatif à son diamètre (l'épaisseur). La résistance dans un conducteur produit des effets indésirables comme une perte de tension et une surchauffe. La taille (l'épaisseur) des conducteurs est classée par le AWG (American Wire Gauge). Les conducteurs qui sont plus épais que la taille AWG #4/0 sont classé par MCM/kcmil.

SECTION 3 | Installation

Les conducteurs sont protégés par des matériaux isolants classés pour une température spécifique, par exemple, une température de 90°C/194°F. Le flux de courant produit de la chaleur et affecte l'isolation. Alors, il y a une valeur de courant maximale (aussi appelé « L'ampacité ») qui est permise pour chaque taille de conducteur et pour la classification température de l'isolation. Les matériaux isolants des câbles seront aussi affecter par la température de fonctionnement élevée des bornes, à qui ils sont connectés. L'ampacité des câbles est basé sur UL-1741 et la Norme Nationale Électrique (NEC)-2014. « Notes for table 3.1 »

Le circuit d'entrée CC doit subir à des courants CC forts et ainsi, il faut que la taille des câbles et des connecteurs est sélectionnée pour réduire la perte de tension entre la batterie et l'onduleur. Avec des câbles moins épais et des connexions lâches la performance de l'onduleur est diminuée et en plus, ça pourrait produire une réchauffement anormale qui risque de fondre l'isolation ou commencer un incendie. Normalement, il faut que le câble soit assez épais pour réduire la perte de tension, dû au courant/ la résistance du câble, à moins que 2%. Utilisez des câble multifiliaires (fils en cuivre et résistant à l'huile) qui sont classés au moins à 90° C. N'utilisez pas des câbles en aluminium car ils ont une résistance plus haute (par la longueur de l'unité). On peut acheter des câbles aux magasins de fournitures pour marin/ soudage.

Les effets d'une faible tension pour des charges électriques communes

- **Circuits d'allumage** - incandescent et Halogène Quartz: Une perte de tension à 5% causera une perte de 10% de la lumière émise. Cet effet est grâce à deux choses, non seulement l'ampoule reçoive moins de puissance mais, aussi le filament refroidi change de la chaleur-blanc à la chaleur-rouge, qui émet moins de lumière visible.
- **Circuits d'allumage** - fluorescent: la perte de tension est presque proportionnelle à la perte de la lumière émise.
- **Moteurs à Induction CA** - Souvent, ils font partie des outils électriques, des dispositifs, pompe à puits, etc. Au démarrage, ils exigent une surcharge de puissance. Si la tension baisse trop, ils pourraient pas marcher et même seront endommager.
- **Circuit de rechargement de batterie PV** - La perte de tension pourrais causer une perte de puissance disproportionnée. Par exemple, une perte de tension à 5% peut réduire le courant de charge par un pourcentage beaucoup plus grande que 5%.

3.5.4 Fuse Protection In The Battery Circuit

A battery is an unlimited source of current. Under short circuit conditions, a battery can supply thousands of Amperes of current. If there is a short circuit along the length of the cables that connects the battery to the inverter, thousands of Amperes of current can flow from the battery to the point of shorting and that section of the cable will become red-hot, the insulation will melt and the cable will ultimately break. This interruption of very high current will generate a hazardous, high temperature, high-energy arc with accompanying high-pressure wave that may cause fire, damage nearby objects and cause injury. To prevent occurrence of hazardous conditions under short circuit conditions, the fuse used in the battery circuit should limit the current **(should be "Current Limiting Type")**, blow in a very short time **(should be Fast Blow Type)** and at the same time, quench the arc in a safe manner. For this purpose, **UL Class T fuse or equivalent** should be used **(As per UL Standard 248-15)**. This special purpose current limiting, very fast acting fuse will blow in less than 8 ms under short circuit conditions. **Appropriate capacity of the above Class T fuse or equivalent should be installed within 7" of the battery Plus (+) Terminal (Please see Table 3.1 for fuse sizing).**

Marine Rated Battery Fuses, MRBF-xxx Series made by Cooper Bussmann may also be used. These fuses comply with ISO 8820-6 for road vehicles.

SECTION 3 | Installation



WARNING!

It is mandatory to use appropriately sized external fuse in the battery and External Charger Circuits. If external fuse is not used and reverse polarity connection is made by oversight, the input section of the unit will be damaged/burnt. **Warranty will be voided in such a situation.**



ATTENTION!

Il est obligatoire d'utiliser un fusible externe de taille appropriée à la batterie et les circuits chargeur externe . Si le fusible externe est pas utilisé et les inversions de polarité est faite par la surveillance , la section d'entrée de l'unité est endommagée / brûlé . **La garantie sera annulée dans une telle situation .**

3.5.5 DC Input Connection for Battery

Battery is connected to terminals 1, 2 shown in Fig 3.8. The terminal consists of M10 Stud & Nut. Tightening torque for the nut is 70 kgf.cm (5 lbf.ft). **Sizes of cables and fuses are shown in Table 3.1.** Sizing is based on safety considerations specified in UL-1741 and NEC-2014. See details under "Notes for Table 3.1".

3.5.6 DC Input Connection for External Charger

External charger is connected to terminals consisting of M12 Stud with Thumb Nut (3, 4 in Fig. 5.3).

- Max current fed through these terminals should be < 50A
- Use wire size given in Table 3.1.
- Tightening torque for the Thumb Nut is 35 kgf.cm (2.5 lbf.ft)
- Use 70A fuse in series with the Positive wire to protect against short circuit along the length of the connecting wires.

Fuse should be close to the Positive Input Terminal 3.

SECTION 3 | Installation

TABLE 3.1 SIZING OF BATTERY SIDE CABLES AND EXTERNAL BATTERY SIDE FUSES

Item (Column 1)	Rated Continuous DC Input Current (See Note 1) (Column 2)	NEC Ampacity = 125% of Rated DC Input Current at Column 2 (See Note 2) (Column 3)	90°C Copper Conductor. Size Based on NEC Ampacity at Column (3) or 2% Voltage Drop, whichever is Thicker (See Note 3)				External Fuse Based on NEC Ampacity at Column (3) (See Note 4) (Column 9)
			Cable Running Distance between the Unit and the Battery (Cable Routing In Free Air)		Cable Running Distance between the Unit and the Battery (Cable Routing In Raceway)		
			Up to 5 ft. (Column 5)	Up to 10 ft. (Column 6)	Up to 5 ft. (Column 7)	Up to 10 ft. (Column 8)	
EVO-2212	266A	333A	AWG#3/0	AWG #4/0 (This size, based on 2% voltage drop, is thicker than NEC based size)	2 X AWG #4/0 (MCM 350)	2 X AWG #4/0 (MCM 350)	350A
EVO-2224	133A	166A	AWG #2	AWG #2	AWG #1/0	AWG #1/0	175A
EVO-3012	373A	466A	2 X AWG #3/0 (MCM 300)	2 X AWG #3/0 (MCM 300)	Not recommended	Not recommended	500A
EVO-4024	266A	333A	AWG#3/0	AWG #4/0 (2% voltage drop is thicker)	2 X AWG #4/0 (MCM 350)	2 X AWG #4/0 (MCM 350)	350A
External Charger	50A	63A	AWG #6 (2% voltage drop is thicker)	AWG #2 (2% voltage drop is thicker)	AWG #6	AWG #2 (2% voltage drop is thicker)	70A

NOTES FOR TABLE 3.1 - SIZING OF BATTERY SIDE CABLES AND EXTERNAL BATTERY SIDE FUSES

- 1) Column 2 indicates the Rated Continuous DC Input Current drawn from the battery in Inverter Mode
- 2) Column 3 indicates NEC Ampacity based on which cable conductor sizes (Columns 5 to 8) are determined. NEC Ampacity is not less than 125% of the Rated Continuous DC Input Current (Column 2) - Refer to NEC-2014 (National Electrical Code) - Section 215.2(A)(1)(a) for Feeder Circuits.
- 3) Columns 5 to 8 indicate cable conductor size that is based on the following 2 considerations. Thicker conductor out of the following 2 considerations has been chosen:
 - a) As per guidelines in NEC-2014 (National Electrical Code) - Ampacity Table 310.15(B)(16) for Raceway and Ampacity Table 310.15(B)(17) for Free Air. Conductor size is based on (i) NEC Ampacity specified at Column 3, (ii) Copper conductor with temperature rating of 90°C and (iii) Ambient temperature of 30°C / 86°F
 - b) Voltage drop across the length of cables has been limited to 2% of 12V / 24V. Voltage drop has been calculated by multiplying the Rated DC Input Current (Column 2) and the resistance of the total length of Copper conductor (the total length of conductor has been taken as 2 times the running distance between the unit and the battery to cover 2 lengths of Positive and Negative cable conductors).

SECTION 3 | Installation

- 4) Column 9 indicates the size of external fuse in the battery circuit. It is mandatory to install this fuse within 7" of the battery Positive terminal to protect the internal DC Input Section of the unit and also to protect the battery cables against short circuit. Amp rating of the fuse is based on the following considerations:
- Not less than NEC Ampacity of 125% of the Rated Continuous DC Input Current (Column 3) - Refer to NEC-2014 (National Electrical Code) - Section 215.3
 - Closest Standard Ampere Rating of Fuse has been used - Refer to NEC-2014 (National Electrical Code) - Section 240.6(A)
 - Where Standard Fuse Rating does not match the required Ampacity of 125% of the Rated Continuous DC Input Current (Column 3), the next higher Standard Rating of the fuse has been used - Refer to NEC-2014 (National Electrical Code) - Section 240.4(B)
 - Type of fuse: Fast-acting, Current Limiting, UL Class T (UL Standard 248-15) or equivalent

3.5.7 Using Proper DC Cable Termination

The battery end and the inverter end of the wires should have proper terminal lugs that will ensure a firm and tight connection. Choose lugs to fit the wire size and the stud sizes on the inverter and battery ends.

3.5.8 Reducing RF Interference

To reduce the effect of radiated interference, shield the wires with sheathing / copper foil / braiding. For details, refer to "Limiting Electro-Magnetic Interference" at Section 1.3.4.

3.5.9 Taping Battery Wires Together To Reduce Inductance

Do not keep the battery wires far apart. Keep them taped together to reduce their inductance. Reduced inductance of the battery wires helps to reduce induced voltages. This reduces ripple in the battery wires and improves performance and efficiency. For details, refer to "Limiting Electro-Magnetic Interference" at Section 1.3.4.

SECTION 3 | Installation

3.6 AC INPUT AND OUTPUT - LAYOUT AND CONNECTION ARRANGEMENT

AC side layout and connection arrangement are shown in Fig 3.9.

1. Cover plate for pocket for AC Input/Output terminals
2. Pocket for AC Input/Output Terminals (behind cover plate 1)
3. AC Input/Output Terminal Block
 - Terminal hole diameter: 6mm for up to AWG #6
 - Set Screw: M4
4. Grid Input - Line
5. Grid Input - Ground
6. Grid Input - Neutral
7. Generator Input - Line
8. Generator Input - Ground
9. Generator Input - Neutral
10. AC Output - Line
11. AC Output - Ground
12. AC Output - Neutral
13. Male/Female Insulated Quick Disconnect for disabling Output Neutral to chassis Ground bond in Inverter Mode (Please see Section 4.5.1 to 4.5.3 and Fig 3.1.2)

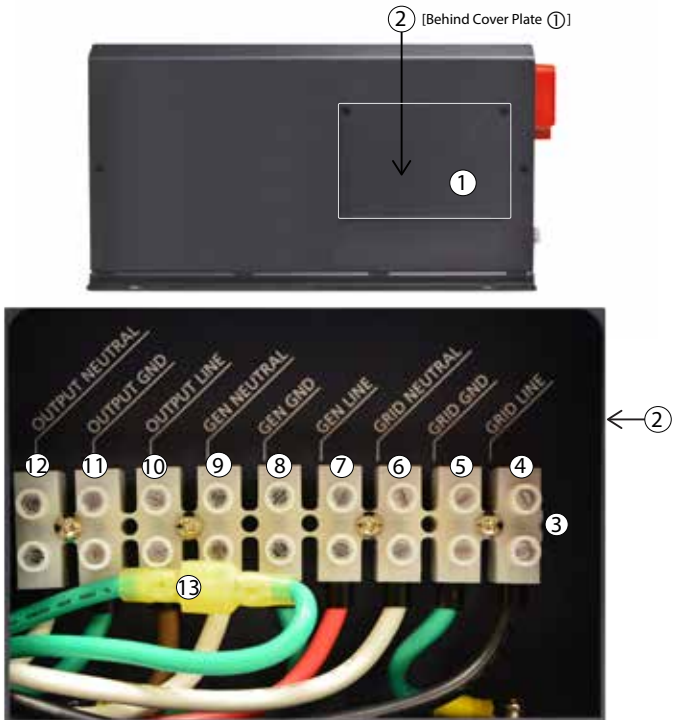

Fig 3.9 AC Input and Output

SECTION 3 | Installation

3.6.1 System Grounding and Output Neutral to Chassis Ground Bond Switching



WARNING!

- In "Inverting Mode" (default condition), the Neutral of the AC output of the unit gets bonded to the metal chassis of the unit through the internal "Neutral to Chassis Switching Relay" [Relay K4 in Figs 4.1(a) and 4.1(b)].
- In "Charging Mode", the internal "Output Neutral to Chassis Switching Relay" disconnects the Neutral of the AC output connection from the chassis of the unit. The Neutral of the AC output connection of the unit will get bonded to the Earth Ground through the Neutral to Earth Ground bond in the AC Breaker Panel/Load Center supplying Grid power / AC output connections of the generator.
- **Disabling Neutral to Ground Bond:** In some applications, the Output Neutral may be required to remain isolated from chassis/ground at all times. For this, automatic Output Neutral to chassis Ground bond can be disabled by disconnecting the Male/Female Disconnect (13, Fig 3.9) located in the AC Wiring Compartment.
- System grounding, as required by National / Local Electrical Codes / Standards, is the responsibility of the user / system installer.

For further details please refer to Sections 4.5.1 to 4.5.3.



ATTENTION!

- En état de défaut, le neutre de la sortie CA de l'unité dans le "Mode de l'onduleur / décharge" obtient lié au châssis métallique de l'unité à travers la interne "Neutre à châssis relais de commutation". Dans "Mode de chargement", l'interne "Neutre à châssis relais de commutation" déconnecte le neutre de la connexion de sortie AC du châssis de l'unité. Le neutre de la connexion de sortie CA de l'unité va obtenir lié à la terre des masses à travers le neutre à la terre liaison au sol dans le centre de panneau de disjoncteurs AC / charge alimenter Grille / connexions de sortie CA du générateur.
- Mise à la terre du système, tel que requis par la National / codes électriques locaux / normes, est de la responsabilité de l'installateur utilisateur / système.

3.6.2 AC Input Considerations – Voltage And Frequency

The EVO unit is designed to accept 120 VAC, 60 Hz / 50 Hz single phase AC power from Grid or generator. These 120V versions come preset for 60 Hz operation. Frequency can be programmed at 50 Hz using optional Remote Control EVO-RC (see Appendix A).

3.6.3 Preventing Paralleling of the AC Output



WARNING!

The AC output of the unit cannot be synchronized with another AC source and hence, it is not suitable for paralleling on the output side. The AC output of the unit should never be connected directly to an electrical breaker panel / load center which is also fed from another AC source. Such a connection may result in parallel operation of different power sources and AC power from the other AC source will be fed back into the unit which will instantly dam-

SECTION 3 | Installation

age the output section of the unit and may also pose a fire and safety hazard. If an electrical breaker panel / load center is fed from this unit and this panel is also required to be powered from additional alternate AC source, the AC power from the additional AC source should first be fed to a suitable Manual/Automatic Transfer Switch and the output of the transfer switch should be connected to the electrical breaker panel / load center. To prevent possibility of paralleling and severe damage to the inverter, never use a simple jumper cable with a male plug on both ends to connect the AC output of the inverter to a handy wall receptacle in the home / RV.



ATTENTION!

Prévention en parallèle de la sortie AC

La sortie de courant alternatif de l'unité ne peut pas être synchronisée avec une autre source de courant alternatif et, par conséquent, il ne convient pas pour mise en parallèle du côté de la sortie. La sortie AC de l'unité ne doit jamais être connecté directement à un panneau central / de charge disjoncteur électrique qui est également alimenté par une autre source de courant alternatif. Une telle connexion peut entraîner un fonctionnement parallèle de différentes sources d'énergie et la puissance AC de l'autre source de courant alternatif est réinjecté dans l'unité qui va instantanément endommager la section de sortie de l'unité et peuvent aussi poser un risque d'incendie et de sécurité. Si un centre panneau de disjoncteur électrique / charge est alimentée à partir de cette unité et ce panneau est également nécessaire pour être alimenté à partir de suppléant supplémentaire source de courant alternatif, l'alimentation de la source de courant alternatif supplémentaire doit d'abord être introduit dans un manuel approprié / commutateur de transfert automatique et le sortie du commutateur de transfert doit être relié au centre panneau / de la charge électrique du disjoncteur. Pour éviter possibilité de mise en parallèle et de graves dommages à l'onduleur, ne jamais utiliser un câble de raccordement simple avec une fiche mâle sur les deux extrémités pour raccorder la sortie AC de l'onduleur à une prise murale à portée de main à la maison / RV.

3.6.4 Connecting to Multi-wire Branch Circuits

DO NOT directly connect the Hot side of the 120 VAC of the unit to the two Hot Legs of the 120 / 240 VAC Breaker Panel / Load Center where Multi-wire (common Neutral) Branch Circuit wiring method is used for distribution of AC power. This may lead to overloading / overheating of the Neutral conductor and is a risk of fire.

A split phase transformer (Isolated or Auto-transformer) of suitable VA rating (25 % more than the VA rating of the unit) with Primary of 120 VAC and Secondary of 120 / 240 VAC (Two 120 VAC split phases 180 degrees apart) should be used. The Hot and Neutral of the 120 VAC output of the inverter should be fed to the Primary of this transformer and the 2 Hot outputs (120 VAC split phases) and the Neutral from the Secondary of this transformer should be connected to the Electrical Breaker Panel / Load Center.

Please see details on-line under White Paper titled "120 / 240 VAC Single Split Phase System and Multi-wire Branch Circuits" at: www.samlexamerica.com (Home > Support > White Papers).

Connexion à multi-fils Circuits de dérivation

NE PAS connecter directement le côté chaud de 120 VAC de l'unité pour les deux Hot Legs de la / Centre de charge 120/240 VAC panneau de disjoncteurs où Multi-fil (neutre commun) du circuit de dérivation méthode de câblage est utilisé pour la distribution de l'alimentation secteur. Cela peut conduire à une surcharge / surchauffe du conducteur neutre et un risque d'incendie.

Un transformateur à décalage de phase (isolé ou d'auto-transformateur) de la notation approprié VA (25% de plus que la puissance en VA de l'unité) avec primaire de 120 VAC et secondaire de 120/240 VAC (deux 120 VAC diviser phases à 180 degrés) devrait être utilisés. Le fil neutre de la sortie 120 VAC de l'onduleur doivent être nourris à la

SECTION 3 | Installation

primaire de ce transformateur et les deux sorties chaud (120 VAC divisé phases) et le neutre du secondaire de ce transformateur doit être relié au panneau de disjoncteur électrique / Centre de gravité.

Se il vous plaît voir les détails en ligne sous Livre blanc intitulé "120/240 VAC Split système phase et multi-fils Circuits de dérivation" à: www.samlexamerica.com (Accueil> Support> Livres blancs).

3.7 AC INPUT & OUTPUT WIRING



WARNING!

Please ensure that the AC input voltage from the Grid / Generator is connected to the AC input terminals and not to the AC output terminals and that this connection is made only when the unit is in OFF condition.

Please note that when the unit is powered on, a Self Test is carried out which includes a check if the AC input voltage from the Grid / Generator connection has been erroneously connected to the AC output terminals instead of AC input terminals. If this wrong connection is detected, (voltage > 10 VAC is seen on terminals OUTPUT LINE & OUTPUT NEUTRAL at the time of switching on of the unit), the unit will not be powered on and a message "Output Fault" will be displayed. This protection against error in connection of the AC input wiring is active only when this wrong connection is made when the unit is in OFF condition and is switched ON subsequently.

If the AC input voltage from the Grid / Generator is erroneously connected / fed to the AC output connections when the unit is ON condition, the above protection will not work and the Inverter Section will be burnt instantaneously and may become a fire hazard.



ATTENTION!

Se il vous plaît faire en sorte que la tension d'entrée d'alimentation de la grille / générateur est reliée aux bornes d'entrée de courant alternatif, et non aux bornes de sortie à courant alternatif et que cette connexion est établie uniquement lorsque l'appareil est dans un état hors tension.

Se il vous plaît noter que lorsque l'appareil est sous tension, un auto-test est effectué qui inclut un contrôle si la tension d'entrée CA de la connexion réseau / générateur a été à tort connecté aux bornes de sortie CA à la place de bornes d'entrée AC. Si cette mauvaise connexion est détectée, (tension > 10 V ca se voit sur les bornes de sortie LINE et neutre de sortie au moment de la mise sous tension de l'appareil), l'unité ne sera pas allumé et un message "Sortie défaut" sera affiché. Cette protection contre les erreurs dans le cadre du câblage d'alimentation est active uniquement lorsque cette mauvaise connexion est établie lorsque l'appareil est en état hors et est allumé par la suite.

Si la tension d'entrée CA de la Grille / générateur est erronée connecté / nourri aux connexions de sortie CA lorsque l'appareil est en état, la protection ci-dessus ne fonctionnera pas et la Section de l'onduleur sera brûlé instantanément et peut devenir un risque d'incendie.

3.7.1 AC Input/Output Supply Connections

The AC input and output supply connections are located in a pocket protected by a cover with a removable front plate (1,2 Fig 3.9). Three 27.8mm / 1¹/₃₂" diameter holes (10A to 10C, Fig 2.1) have been provided for cable / conduit entry. Remove the caps covering the holes and install appropriate 3/4" Trade Size Fitting for routing the AC input and output wires/conduits.

Screw down type of terminal block (3, Fig 3.9) is used for connecting the wires. The hole size for wire entry is 6 mm and set screw size is M4. It can accommodate conductors with solid or multi-stranded wire size range of AWG #6 to AWG #20.

SECTION 3 | Installation

Strip adequate insulation from the end of the wire (Fig. 3.11). Avoid nicking the wire when stripping the insulation. Wire End Terminals have been provided (see Section 2.6, page 27) for firm connection under the set screw. Insert the bare end of the wire into the barrel portion of the Wire End Terminal & crimp barrel portion using suitable crimping tool (Fig 3.11).

Insert the terminated end of the wire fully into the terminal slot till it stops. Tighten the screw firmly. Tightening torque for the screws – 7 to 12 Kgf*cm / 0.5 to 0.9 lbf*ft.

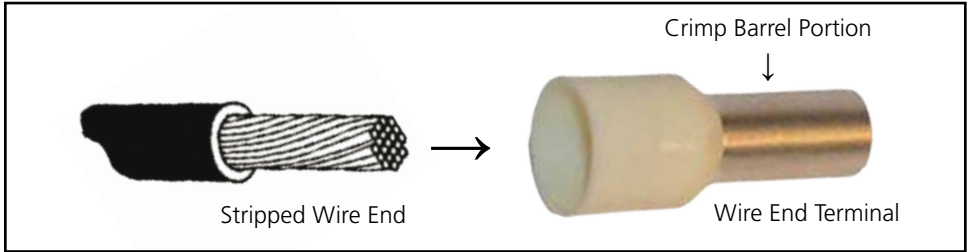

Fig 3.11 Stripped Wire End Terminal on AC Wiring

3.8 SIZING OF WIRING AND BREAKERS - AC INPUT SIDE



WARNING!

AC Breakers for the AC input circuits have NOT been provided internally. These have to be provided externally by the installer / user based on guidelines given below. Please note that guidelines given below on wire sizing and over-current protection will be superseded by the applicable National / Local Electrical Codes.



ATTENTION!

Breakers AC pour les circuits d'entrée AC ont pas été fournis en interne. Ceux-ci doivent être fournies à l'extérieur par l'installateur / utilisateur sur la base des directives données ci-dessous. Se il vous plaît noter que les directives ci-dessous sur dimensionnement des câbles et protection contre les surintensités seront remplacées par les nationaux / codes électriques locaux applicables.

3.8.1 Tables for Wire and Breaker Sizing - AC Input Side

Tables 3.2.1 to 3.2.3 provide details of wire and breaker sizing for the AC input side.

- **Table 3.2.1:** For EVO-2212, 2224, 3012 and 4024 with AC Input Current Limit (Max Current) set at 30A (Default Setting)
- **Table 3.2.2:** For EVO-3012 and 4024 when AC Input Current Limit (Max Current) is programmed at 45A
- **Table 3.2.3:** For EVO-4024 when AC Input Current Limit (Max Current) is programmed at 60A

AC wiring and breaker sizes depend upon the maximum continuous AC input current under various operating conditions described in the succeeding paragraphs.

- The Maximum Load Current on the output side has to be limited to the rated output Amp

SECTION 3 | Installation

capacity of the specific model when operating in Inverter Mode (Column 1).

- When Grid / Generator input is available and the unit is operating in Charging / Pass Through Mode, the AC Input Current will be determined as follows:
 - The maximum possible AC Input Current (Column 4) for a particular model will be equal to the sum of the Rated AC Side Battery Charging Current (Column 3) and the Rated Pass Through current (Column 2). Rated Pass Through Current (Column 2) = the Rated Output Current in Inverter Mode (Column 1).
 - The AC Input current in Charging / Pass Through Mode will be restricted by the maximum Amp rating of the Generator or the Amp rating of the breaker in the Grid Branch Circuit that is feeding the unit. The AC Input Current drawn by the unit can be programmed to the desired limit (Column 5) to match the output Amp rating of the Generator or the Amp rating of breaker in the Grid Branch Circuit. Optional Remote Control EVO-RC is required to change this limit (See Appendix A under Group 2 Parameter Select for Input Settings-"Max Current"). All the 4 models EVO-2212, 2224, 3012 and 4024 come with Input Current Limit set at 30A (Default Setting). See Table 3.2.1.
 - Higher Power Models will require higher Amp rating of the Generator / the Grid Branch Circuit. Wiring and breaker sizing for Input Current Limit at 45A for EVO-3012, 4024 is given at Table 3.2.2 and for 60A for EVO-4024 is given at Table 3.2.3.

Model No. and Rated Output Power in Inverter Mode (Column 1)	Rated AC Pass Through Current (See Note 1) (Column 2)	Rated AC Charging Current (See Note 2) (Column 3)	Total Rated AC Input Current (Columns 2 +3) (See Note 3) (Column 4)	Programmed AC Input Current Limit (See Note 4) (Column 5)	NEC Ampacity = 125% of Column 5 (See Note 5) (Column 6)	Conductor Size Based on NEC Ampacity at Column 6 (See Note 6) (Column 7)	External Breaker Size Based on NEC Ampacity at Column 6 (See Note 7) (Column 8)
EVO-2212 (2200VA, 18A)	18 A	15A	33A	30A (Default)	37.5A	AWG #8	40A
EVO-2224 (2200VA, 18A)	18A	19A	37A				
EVO-3012 (3000VA, 25A)	25A	20A	45A				
EVO-4024 (4000VA, 33A)	33A	29A	62A				

SECTION 3 | Installation

TABLE 3.2.2 SIZING OF GRID AND GENERATOR INPUT WIRING AND BREAKERS (FOR INPUT CURRENT LIMIT PROGRAMMED AT 45A FOR EVO-3012 AND EVO-4024)							
Model No. and Rated Output Power in Inverter Mode (Column 1)	Rated AC Pass Through Current (See Note 1) (Column 2)	Rated AC Charging Current (See Note 2) (Column 3)	Total Rated AC Input Current (Columns 2 +3) (See Note 3) (Column 4)	Pro-grammed AC Input Current Limit (See Note 4) (Column 5)	NEC Ampacity = 125% of Column 5 (See Note 5) (Column 6)	Conductor Size Based on NEC Ampacity at Column 6 (See Note 6) (Column 7)	External Breaker Size Based on NEC Ampacity at Column 6 (See Note 7) (Column 8)
EVO-3012 (3000VA, 25A)	25A	20A	45A	45A	56.25A	AWG #6	60A
EVO-4024 (4000VA, 33A)	33A	29A	62A				

TABLE 3.2.3 SIZING OF GRID AND GENERATOR INPUT WIRING AND BREAKERS (FOR INPUT CURRENT LIMIT PROGRAMMED AT 60A FOR EVO-4024)							
Model No. and Rated Output Power in Inverter Mode (Column 1)	Rated AC Pass Through Current (See Note 1) (Column 2)	Rated AC Charging Current (See Note 2) (Column 3)	Total Rated AC Input Current (Columns 2 +3) (See Note 3) (Column 4)	Pro-grammed AC Input Current Limit (See Note 4) (Column 5)	NEC Ampacity = 125% of Column 5 (See Note 5) (Column 6)	Conductor Size Based on NEC Ampacity at Column 6 (See Note 6) (Column 7)	External Breaker Size Based on NEC Ampacity at Column 6 (See Note 7) (Column 8)
EVO-4024 (4000VA, 33A)	33.33A	29A	62.33A	60A	75A	AWG #4 or 2 x AWG #6	80A

NOTES FOR TABLES 3.2.1, 3.2.2 and 3.2.3 - SIZING OF GRID AND GENERATOR INPUT WIRING AND BREAKERS

- 1) Column 2 indicates the Rated AC Pass Through Current when in Charger / Pass Through Mode (value of this current = Rated AC Output Current in Inverter Mode).
- 2) Column 3 indicates the Rated AC Side Charging Current in Charger / Pass Through Mode.
- 3) Column 4 indicates the total Rated AC Input Current which is the sum of the Rated AC Pass Through Current (Column 2) and the Rated AC Side Charging Current (Column 3).
- 4) Column 5 indicates the Programmed AC Input Current Limit. The value of this current is programmable using the optional Remote Control Model EVO-RC (See Appendix A under Group 2 Parameter Setup for Input Settings- "Max Current"). Appropriate value can be programmed to match the available capacity of the Grid input AC Branch Circuit or the rated capacity of the Generator. Default value for all the 4 models is 30A.
- 5) Column 6 indicates NEC Ampacity based on which the wiring conductor size (Column 7) is determined. This NEC Ampacity is not less than 125% of the Programmed AC Input Current Limit (Column 5) - Refer to NEC-2014 (National

SECTION 3 | Installation

Electrical Code) - Section 210.19(A)(1)(a) regarding minimum Ampacity and size of Branch Circuit Conductors.

- 6) Column 7 indicates the wiring conductor size that has been determined based on NEC-2014 (National Electrical Code) - Ampacity Table 310.15(B)(16) for Raceway. This conductor size is based on (i) NEC Ampacity (Column 6) (ii) conductor temperature of 75°C and (iii) ambient temperature of 30°C / 86°F.
- 7) Column 8 indicates the Amp rating of EXTERNAL breaker that is required to be installed in the Load Center / Breaker Panel feeding the unit. The Amp rating of this breaker is based on the following considerations:
 - a. Not less than the NEC Ampacity (Column 6) - Refer to NEC-2014 (National Electrical Code) - Section 210.20(A) regarding overcurrent protection of Branch Circuit Conductors
 - b. Closest Standard Ampere Rating of Breaker has been used - Refer to NEC-2014 (National Electrical Code) - Section 240.6(A) regarding overcurrent protection
 - c. Where Standard Breaker Rating does not match the required NEC Ampacity (Column 6), the next higher Standard Rating of the breaker has been used - Refer to NEC-2014 (National Electrical Code) - Section 240.4(B) regarding over current devices
 - d. Type of breaker: Standard circuit breaker for 120VAC Load Center /Breaker Panel

3.9 SIZING OF WIRING AND BREAKERS - AC OUTPUT SIDE



WARNING!

AC Breakers for the AC output circuits have **NOT** been provided internally. These have to be provided externally by the installer / user based on guidelines given below. Please note that guidelines given below on wire sizing and over-current protection will be superseded by the applicable National / Local Electrical Codes



ATTENTION!

Breakers AC pour les circuits d'entrée AC ont pas été fournis en interne. Ceux-ci doivent être fournies à l'extérieur par l'installateur / utilisateur sur la base des directives données ci-dessous. Se il vous plaît noter que les directives ci-dessous sur dimensionnement des câbles et protection contre les surintensités seront remplacées par les nationaux / codes électriques locaux applicables.

3.9.1 Tables for Wire and Breaker Sizing - AC Output Side

Table 3.3 provides details of wire and breaker sizing for the AC output side.

AC wiring and breaker sizes on the AC output side are required to be determined by the Rated Load Current when operating in Inverter Mode (Column 1).

SECTION 3 | Installation

Table 3.3 SIZING OF AC OUTPUT WIRING AND BREAKERS				
Item Model No. and Rated Output Power in Inverter Mode (Column 1)	Rated AC Output Current in Inverter Mode (See Note 1) (Column 2)	NEC Ampacity = 125% of Column 2 (See Note 2) (Column 3)	Conductor Size based on NEC Ampacity at Column 3 (See Note 3) (Column 4)	External Breaker Size based on NEC Ampacity at Column 3 (See Note 3) (Column 5)
EVO-2212 (2200VA, 18A)	18.33A	22.91	AWG #10	25A
EVO-2224 (2200VA, 18A)	18.33A	22.91	AWG #10	25A
EVO-3012 (3000VA, 25A)	25A	31.25	AWG #8	35A
EVO-4024 (4000VA, 33A)	33.33A	41.66	AWG #8	45A

NOTES FOR TABLE 3.3 - AC OUTPUT WIRING AND BREAKERS

- 1) Column 2 indicates the Rated AC Output Current in Inverter Mode
- 2) Column 3 indicates NEC Ampacity based on which the output-wiring conductor is sized. This NEC Ampacity is not less than 125% of the Rated Output Current in Inverter Mode (Column 2). - Refer to NEC-2014 (National Electrical Code) - Section 215.2(A)(1)(a) regarding Feeder Circuit Conductors. PLEASE NOTE that when the unit is operating in Inverter Mode, it is considered to be an AC source that is feeding power to the Load Center / Breaker Panel on the load side. Hence, the AC output circuit of the unit is considered to be a Feeder Circuit for purposes of NEC-2014.
- 3) Column 4 indicates conductor size for the output side wiring. The size is based on NEC-2014 (National Electrical Code) - Ampacity Table 310.15(B)(16) for Raceway. Conductor size is based on (i) NEC Ampacity (Column 3), (ii) conductor temperature of 75°C and (iii) ambient temperature of 30°C / 86°F.
- 4) Column 5 indicates the Amp rating of EXTERNAL breaker that is required to be installed in the Load Center / Breaker Panel that is being fed from the AC output from this unit. Amp rating of the breaker is based on the following considerations:
 - a) Not less than NEC Ampacity (Column 3) - Refer to NEC-2014 (National Electrical Code) - Section 215.3 regarding over-current protection of Feeder Circuit Conductors
 - b) Closest Standard Ampere Rating of Breaker has been used - Refer to NEC-2014 (National Electrical Code) - Section 240.6(A) regarding Standard Ampere Ratings
 - c) Where Standard Breaker Rating does not match the required NEC Ampacity at Column 3, the next higher Standard Ampere Rating of the breaker has been used - Refer to NEC-2014 (National Electrical Code) - Section 240.4(B) regarding over current devices rated 800 Amps or less
 - d) Type of breaker: Standard circuit breaker for 120VAC Load Center /Breaker Panel

SECTION 3 | Installation

3.10 GFCI PROTECTION FOR VEHICLE APPLICATION

When this unit is installed in vehicles, ensure that Ground Fault Circuit Interrupter(s) are installed in the vehicle wiring system to protect all branch circuits. Details of tested and approved GFCI's are given in Table 3.4.

3.11 GROUNDING TO EARTH OR TO OTHER DESIGNATED GROUND

For safety against electrical shock, the metal chassis of unit is required to be grounded to the Earth Ground or to the other designated ground. For example, in a mobile RV, the metal frame of the RV is normally designated as the Negative DC ground / RV Ground. Similarly, Boat Ground is provided in the boats.

An Equipment Grounding Connector (5 in Fig. 3.8) has been provided on the metal chassis for connecting to the appropriate ground through the Equipment Grounding Conductor (EGC). This Equipment Grounding Conductor (EGC), when appropriately bonded to Earth Ground, helps to prevent electric shock and allows over-current devices to operate properly when ground faults occur. The size of this conductor should be coordinated with the size of the over-current devices involved. Marine installations require the size of this conductor to be of the same size as the Battery Negative wire.

Please read following on-line White Papers for complete understanding of Grounding at www.samlexamerica.com (Home > Support > White Papers):

- “Grounded Electrical AC Power Distribution System”
- “Grounding System and Lightning / Ground Fault Protection”

3.12 GROUNDING ARRANGEMENT IN EVO SERIES

Schematic at Fig. 3.12 illustrates the grounding arrangement of EVO Series. Internally, EVO consists of a DC Section and an AC Section that are isolated through a transformer. Both these sections are required to be grounded appropriately.

When using a generator, please ensure that the Neutral of the generator is bonded to Ground Rod.

3.13 DC SIDE GROUNDING (SEE FIG. 3.12)

DC side grounding involves proper grounding of the Negative of the battery, the DC Panel and the DC side of the EVO.

A Grounding Connector (G2) (5 in the DC side layout in Fig. 2.1) is provided for connecting to the System Ground. The connector can accept wire sizes AWG # 4–6. The set screw size is M8.

A DC Panel, as shown in Fig. 3.12, is normally provided to connect the batteries and distribute DC power to the inverter and to the other DC loads.

The Negative of the battery is connected to the Neg (-) Bus, which is connected to the Bus bar for Equipment Grounding Conductors (G3), which in turn is bonded to the Grounding Electrode (GE), also called Ground Rod. Hence, the Battery Negative and the chassis of the DC Panel and the chassis of the EVO will all be bonded to the Earth Ground.

Connect the combined DC and AC Grounding Terminal (G2) (5 in the DC side layout in Fig. 3.8), to the Equipment Grounding Bus Bar (G3) in the DC Panel using AWG #6 insulated stranded copper wire. For application of EVO on a boat, the size of this wire should be of the same size as the battery Negative wire.

SECTION 3 | Installation

The connections must be tight against bare metal. Use star washers to penetrate paint and corrosion. **As the Equipment Grounding Bus Bar (G3) in the DC Panel is bonded to the Grounding Electrode (GE), the chassis of the EVO / DC side will be bonded to Earth Ground.**



WARNING!

For application of EVO on a boat, the size of the Equipment Grounding Conductor (EGC) from the Grounding Terminal on the EVO (G2) to the boat's system Ground, should be the same size as the battery cable.



ATTENTION!

Si vous utilisez le EVO sur un bateau, la taille du conducteur de terre de l'équipement «EGC» pour le côté de terre CC devrait être de la même taille que le câble négatif de la batterie.

3.14 AC SIDE GROUNDING (PLEASE SEE FIG 3.12)

- The AC Input Grounds {GEN GND (8), GRID GND (5)} and AC Output Ground {OUTPUT GND (11)}, are internally bonded to the chassis of the inverter (G1)
- The Equipment Grounding Conductors (part of the Grid/Generator input wiring) from Bus Bars (G3) for the Equipment Grounding Conductors in the Grid and Generator Input Panels are connected to the AC input Ground terminals in {GRID GND (5), GEN GND (8)}.
- The AC output Ground terminal of the EVO {OUTPUT GND (11)} is connected to the Equipment Grounding Conductor of the AC output wire which then connects to the Bus Bar (G3) for the Equipment Grounding Conductors of the AC Distribution Panel.
- The Bus Bar (G3) for Equipment Grounding Conductors of the AC Distribution Panel is connected to the Bus Bar for the Equipment Grounding Conductors (G3) of the Grid/Generator Input Panel, which in turn is connected to the Ground Rod or the Grounding Electrode (GE). **Thus, in keeping with the NEC requirements, the AC Grounds of EVO and the AC Distribution Panel will be bonded to the Earth Ground only at one single point at the Grid/Generator Panel feeding the EVO.**

3.14.1 OUTPUT NEUTRAL TO CHASSIS GROUND BOND SWITCHING

As required by NEC and UL specification 458, AUTOMATIC Output Neutral to Chassis Ground bond switching arrangement has been provided in these units through "Output Neutral to Chassis Ground Bond Switching Relay" [K4 in Figs 4.1(a) and 4.1(b)] to switch bonding of the Output Neutral Connector of the Inverter Charger as follows:

- When operating as an inverter, the current carrying conductor of the Inverter Section that is connected to the Output Neutral connector of the Inverter Charger is bonded to the metal chassis of the inverter by the "Output Neutral to Chassis Ground Bond Switching Relay" [K4 in Figs 4.1(a) and 4.1(b)]. As the metal chassis of the inverter is in turn bonded to the RV Ground (chassis of the RV) or to the Boat Ground (DC Negative Grounding Bus Bar and the Main AC Grounding Bus Bar are tied together in a boat and this is called the "Boat Ground"), this current carrying conductor of the Inverter Section will become the Grounded Conductor (GC) or the Neutral of the Inverter Section.

SECTION 3 | Installation

- When in Charging Mode, the Neutral conductor of the Grid power/Generator will be connected to the Output Neutral connector of the Inverter Charger. At the same time, the "Output Neutral to Chassis Ground Bond Switching Relay" [K4 in Figs 4.1(a) and 4.1(b)] will unbond (disconnect) the Output Neutral connector of the Inverter Charger from the chassis of the Inverter Charger. This will ensure that the Grounded Conductor (GC) / Neutral of the Grid power/Generator is bonded to the Earth Ground at one single point at the location of the AC Power Distribution System of the Marina/RV Park.
- **Disabling Neutral to Ground Bond:** In some applications, the Output Neutral may be required to remain isolated from the chassis/Ground at all times. For this, automatic Output Neutral to Chassis Ground bond can be disabled by disconnecting the Male/Female Quick Disconnect located in the AC wiring compartment. [Please see (i) 13, Fig 3.9 and (ii) "QD" in Figs 4.1(a) and 4.1(b)].

Please read the following on-line White Papers for more details at www.samlexamerica.com (Home > Support > White Papers):

- **"Neutral to Ground Switching in RV and Marine Applications"**

SECTION 3 | Installation

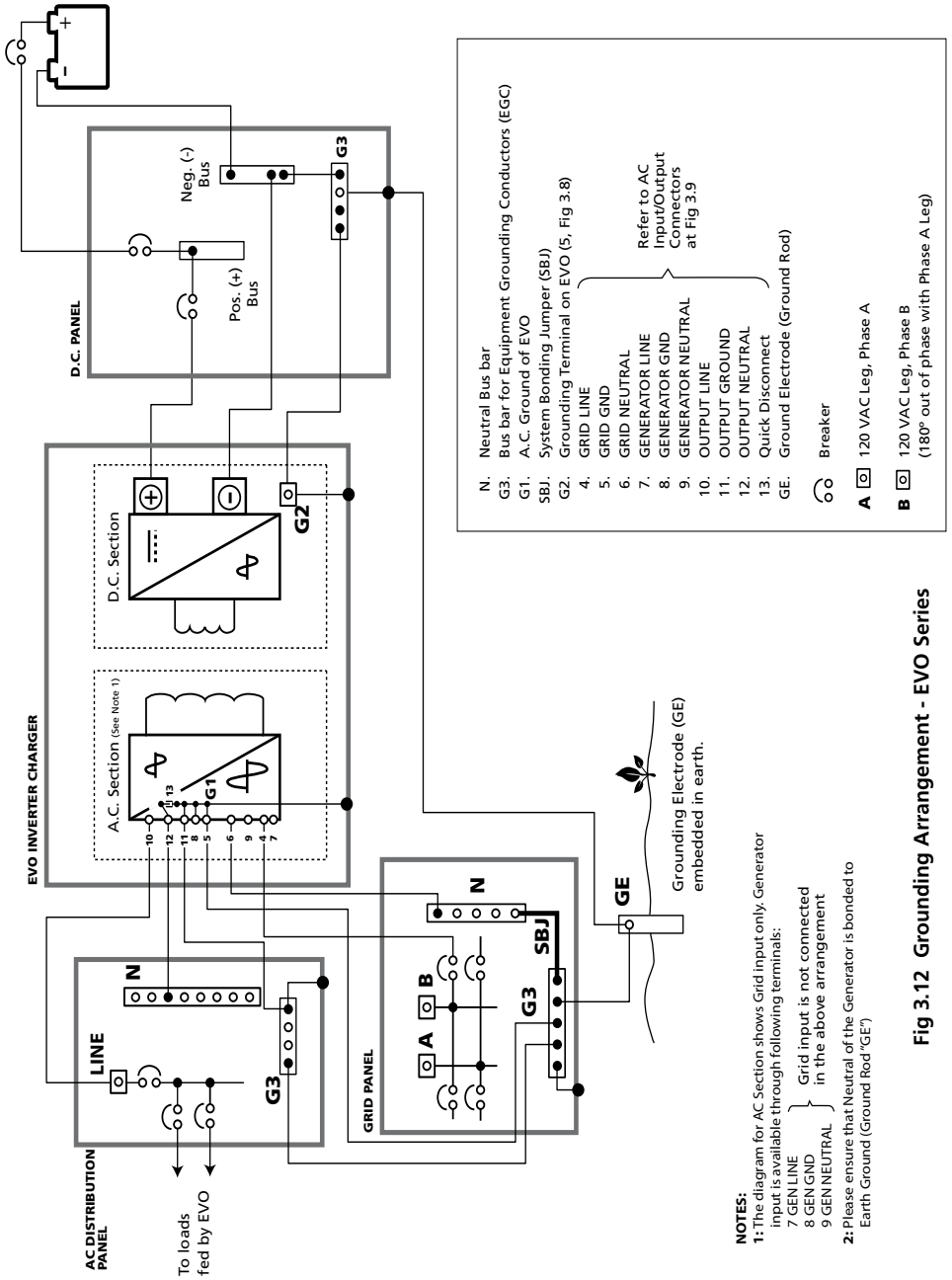

Fig 3.12 Grounding Arrangement - EVO Series

SECTION 3 | Installation

3.15 SHORE BASED INSTALLATION

3.15.1 Typical Shore Based Installation

Fig. 3.13 illustrates a typical shore based installation

- Battery is connected to the DC input connections through an appropriate fuse to protect the DC input cables against short circuit
- Battery Temperature Sensor Model EVO-BCTS is installed on the Positive or Negative post of the battery and connected to the port for the Temperature Sensor
- Supplementary battery charging is being carried out through a solar array and a Charge Controller connected to the DC input provided for external battery charger.
- AC input to the EVO is fed from the Grid and Generator Panel
- AC output from the EVO is fed to the AC Distribution Panel
- Automatic Generator start/stop is possible as follows:
 - Start operation is initiated by closure of "NO" and "Common" contacts of the Status Relay (14, Fig 2.1) when battery voltage drops to the programmed value of the Low Voltage Alarm. Stop sequence is initiated by contact opening when the battery voltage rises to the programmed "Reset Value". Please refer to programming of "Relay Function" under Section 4.8 of EVO-RC Manual at Appendix A.
 - Contact closure/opening signal is fed to the optional Generator Auto Start/Stop Module which in turn feeds required start stop signals to the generator (the generator should be capable of remote start/stop function).
- When using generator, please ensure the following:
 - Neutral of the generator is bonded to the chassis of the generator and the chassis is bonded to the Earth Ground (Ground Rod "GE").
 - If the generator is a 120VAC / 240VAC Split Single Phase with 120 VAC phase fed to the EVO, then both 120VAC Split Phases of the generator should be equally loaded (balanced) to prevent the deterioration of regulation of generator's output voltage. Poor regulation of generator output voltage may lead to interruption of charging in the EVO.

SECTION 3 | Installation

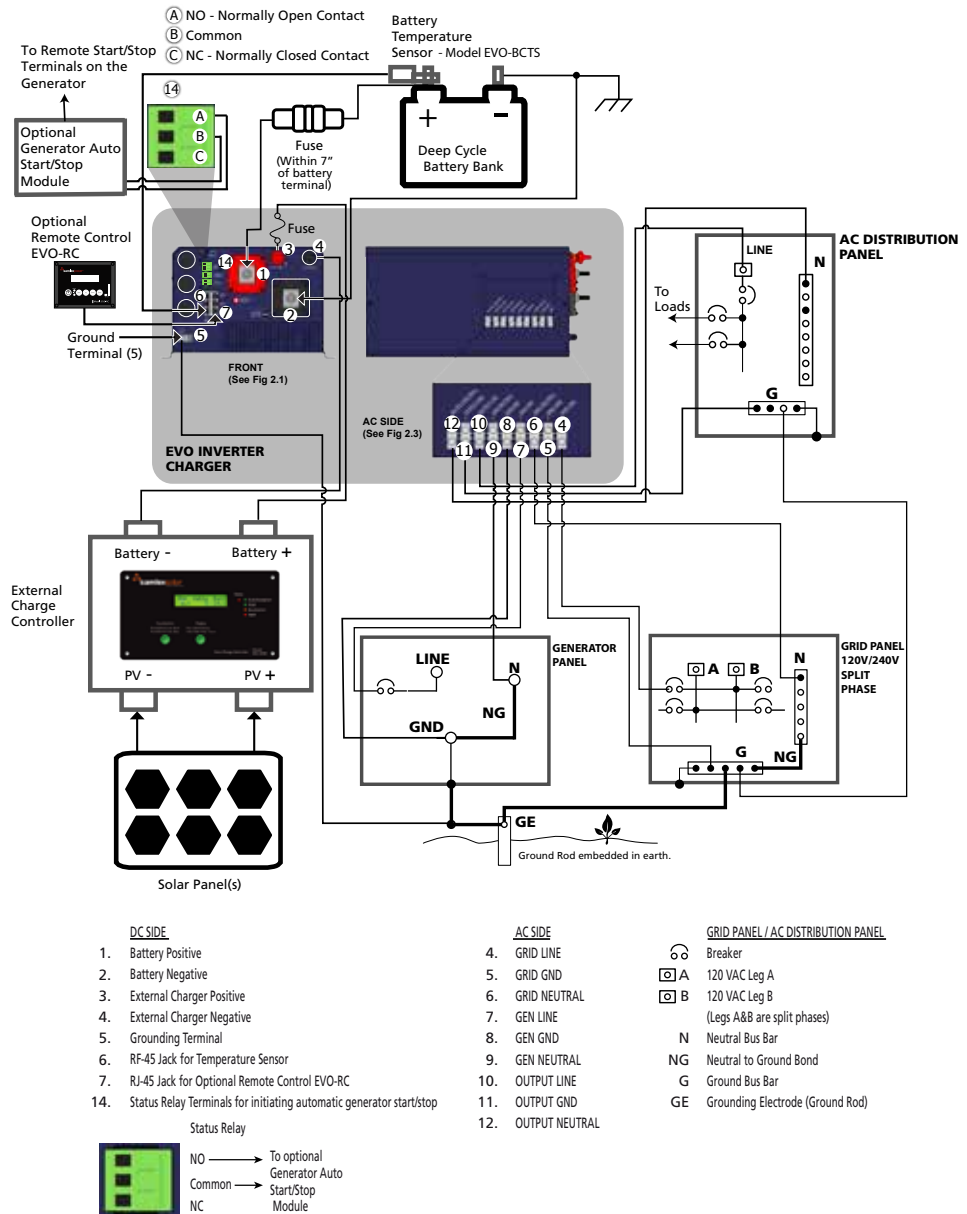

Fig 3.13 Typical Shore Based Installation

SECTION 3 | Installation

3.16 MOBILE INSTALLATION - GENERAL INFORMATION

3.16.1 GFCI Protection For Vehicle Application

When this unit is installed in vehicles, it is to be ensured that Ground Fault Circuit Interrupter(s) [GFCI] are installed in the vehicle wiring system to protect all branch circuits.



WARNING!

Please ensure that Ground Fault Circuit Interrupter(s) [GFCI] are installed in the vehicle wiring system to protect all branch circuits.

GFCIs listed in Table 1.5 have been tested to operate satisfactorily and are acceptable.



ATTENTION!

Veuillez assurer que le(s) disjoncteur(s) de terre [GFCI] est/sont installé dans le système de câblage du véhicule pour protéger tous les circuits de dérivation.

Des disjoncteurs de terre ci-dessous ont été testé. Leur fonctionnement est acceptable, Table 1.5.

3.16.2 Requirement Of Deep Cycle, Auxiliary Battery And Battery Isolator For Powering Inverters In Mobile Installations

Basic information on Lead Acid Batteries is given in Section 1.4 under "General Information - Lead Acid batteries".

For details, read on-line White Paper titled "Batteries, Chargers & Alternator" at: www.samlexamerica.com (Home > Support > White Papers).

An RV / vehicle has Starter, Lighting and Ignition (SLI) battery. As explained in White Paper titled "Batteries, Chargers and Alternators", SLI batteries are designed to produce high power in short bursts for cranking.

SLI batteries use lots of thin plates to maximize the surface area of the plates for providing very large bursts of current (also specified as Cranking Amps). This allows very high starting current but causes the plates to warp when the battery is cycled. Vehicle starting typically discharges 1%–3% of a healthy SLI battery's capacity. The automotive SLI battery is not designed for repeated deep discharge where up to 80% of the battery capacity is discharged and then recharged. If an SLI battery is used for this type of deep discharge application, its useful service life will be drastically reduced. Hence, this type of battery is not recommended for the storage of energy for inverter applications. A second deep cycle auxiliary battery must be installed in the RV for powering the EVO (A deep cycle, auxiliary battery is shown in Fig. 3.14).

When the second auxiliary deep cycle battery is used, a Battery Isolator is required that will allow parallel connection of the two batteries for charging when the alternator is ON and disconnecting the parallel connection when the alternator is stopped (Isolator is shown in Fig. 3.14). The capacity of the Battery Isolator should be as follows:

- **For EVO-2012:** The maximum continuous DC current required is 266A. The capacity of the Battery Isolator should be more than 266A or more than the capacity of the alternator, whichever is higher
- **For EVO-2224:** The maximum continuous DC current required is 133A. The capacity of the Battery Isolator should be more than 133A or more than the capacity of the alternator, whichever is higher

SECTION 3 | Installation

- **For EVO-3012:** The maximum continuous DC current required is 373A. The capacity of the Battery Isolator should be more than 373A or more than the capacity of the alternator, whichever is higher
- **For EVO-4024:** The maximum continuous DC current required is 266A. The capacity of the Battery Isolator should be more than 266A or more than the capacity of the alternator, whichever is higher

3.16.3 Requirement To Keep The Neutral Conductor Of Shore Power Isolated From The Chassis Ground Of The RV

As explained in on-line White Paper titled “Grounded Electrical Power Distribution System” at www.samlexamerica.com (Home > Support > White Papers), in the RV, the Neutral Bus Bar is NOT bonded to the Chassis of the RV. In the RV, the Neutral is floating with respect to the chassis of the RV. This is necessary for safety because if the Neutral was bonded to the chassis of the RV and if the Neutral and the Hot got reversed by mistake, the chassis of the RV will be at 120 VAC with respect to the Earth Ground. If a person standing on the Earth Ground touches the chassis of the RV, he will be fed with 120 VAC and will receive electrical shock!

3.16.4 Typical Mobile Installation

Fig. 3.14 illustrates a typical RV installation using 30A Service Inlet for 30A RV Power Supply Cord:

- Auxiliary Battery is connected to the DC input connections through an appropriate fuse to protect the DC input cables against short circuit
- Auxiliary battery will be charged by the alternator through the Battery Isolator
- Battery Temperature Sensor Model BTS-EVO is installed on the Positive or Negative post of the auxiliary battery and connected to the port for the Temperature Sensor
- Supplementary battery charging is being carried out through a solar array and a Charge Controller connected to the DC input provided for external battery charger
- AC input to the EVO is fed from typical 30A RV Power Inlet (through suitable breaker) and from the generator (through suitable breaker)
- AC output from the EVO is fed to the RV Distribution Panel Board (Use 120V version and NOT 120/240 Split Phase version)
- Automatic Generator start/stop is possible as follows:
 - Start operation is initiated by closure of "No" and "Common" contacts of the Status Relay (14, Fig 2.1) when battery voltage drops to the programmed value of the Low Voltage Alarm. Stop sequence is initiated by opening of above contacts when the battery voltage rises to the programmed "Restart Value". Please refer to programming of "Relay Function" under Section 4.8 of EVO-RC Manual at Appendix A.
 - Contact closure/opening signal is fed to the optional Generator Auto Start/Stop Module which in turn feeds required start stop signals to the generator (the generator should be capable of remote start/stop function).

SECTION 3 | Installation

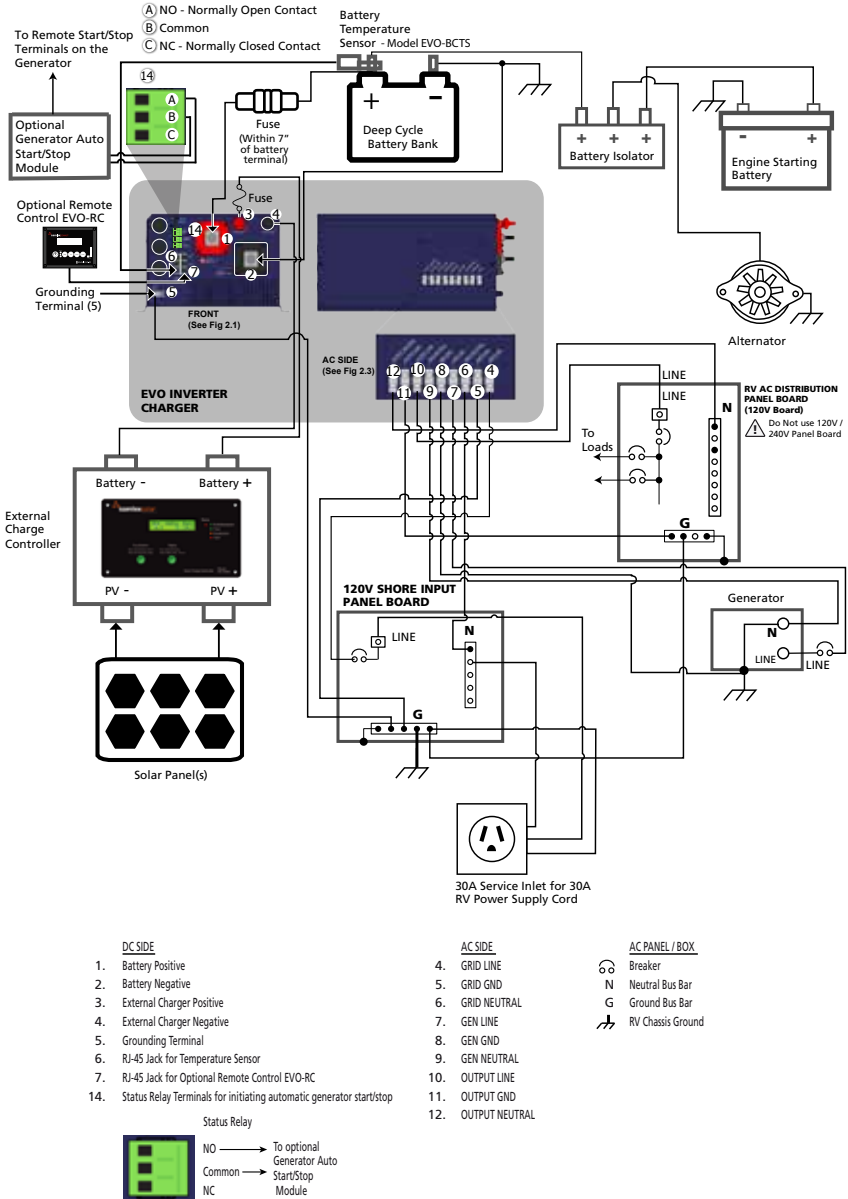

Fig 3.14 Typical Mobile Installation Using 30A RV Service Inlet

SECTION 4 | General Description & Principles of Operations

4.1 GENERAL DESCRIPTION

This unit is a Pure Sine Wave Bi-directional, Single-Phase Inverter / Charger with a Transfer Relay that operates either as an inverter OR as a smart battery charger. It uses a common Converter Section that can work in two directions – in one direction it converts external AC power to DC power to charge the batteries using Grid or Generator (Charging Mode) and in the other direction, it converts DC power from the battery to AC power (Inverting Mode). This allows the same power components to be used in both directions resulting in high-energy transfer efficiency with fewer components. Please note that it can NOT work in both the directions at the same time (i.e. it cannot work as an inverter and as a charger at the same time).

High performance 100 MHz DSP (Digital Signal Processing) micro-controller and Pulse Width Modulated (PWM) conversion circuits are used for the above implementation.

4.2 COMPONENTS OF THE SYSTEM

It consists of 3 Sections – Inverter Section, Battery Charger Section and AC Input/Transfer Relay Section. The unit is fed with the following inputs:

- Up to 2 external AC input power sources – Grid or Generator or both with PRIORITY for Grid if both Grid and Generator inputs are available at the same time
- DC Battery Source consisting of 12V/24V battery bank. - 4 versions of Inverter Charger are available. 2 versions for 12 VDC battery input (EVO-2012 and EVO-3012) & 2 for 24 VDC battery input (EVO-2224 and EVO-4024)
- Additional external charging source like Solar Charge Controller / AC charger of up to 50A capacity. The output of the external charging source is routed through this unit and operates in parallel with the internal charger. The internal charging current is controlled to ensure that the combined current fed to the battery does not exceed the programmed Bulk Charging Current. This improves the life of the battery.

4.3 INVERTER SECTION

The Inverter Section is a heavy-duty, continuous rated, DSP micro-controller based inverter generating a Pure Sine Wave output of 120 VAC, 60 Hz / 50 Hz (60 Hz default) from the DC Battery Source. It is able to supply AC power to various types of AC loads such as resistive loads (heaters, incandescent lamps etc) or reactive loads (motors, air conditioners, refrigerators, vacuum cleaners, fans, pumps, Switched Mode Power Supplies (SMPS) used in audio / video equipment and computers, etc.).

4.3.1 Principle of working of Inverter Section

The low DC voltage from the DC Battery Source is inverted to the AC voltage in two steps. The low DC voltage from the DC Battery Source is first converted to low frequency (60 Hz or 50 Hz), low voltage synthesized sine wave AC using an H-bridge configuration and high frequency PWM (Pulse Width Modulation) technique. The low frequency, low voltage synthesized sine wave is then stepped up to 120 VAC pure sine wave voltage using a low frequency Isolation Transformer and filtration circuit. This type of DC to AC inversion is called Hybrid Type – a combination of low frequency and high frequency implementation. Other distinctive features of the Inverter Section are given below:

SECTION 4 | General Description & Principles of Operations

Soft Start: The inverter design incorporates “Soft Start” feature with the following advantages and protections:

- When the unit powers up, it starts in Inverting Mode first. The output voltage ramps up gradually from around 48 VAC to 120 VAC in around 200 ms. This reduces otherwise very high starting inrush current drawn by AC loads like Switched Mode Power Supplies (SMPS) and motor driven loads like fans, pumps, compressors etc. This will result in lower motor inrush current (which typically can be up to 650% of the full load current of the motor), which means lesser mechanical stresses, wear and tear and increased lifetime of the motor, coupling and fan. Additionally, the impact on the load side components is greatly reduced, meaning less likelihood of causing problematic voltage drops during starting.

Power Surge – Up to 300%:

- The inverter is able to deliver very high surge power / current of up to 300% for 1 ms followed by 200% for 100 ms. This range of high instantaneous power is delivered at the rated voltage and hence, it is able to provide very high starting torque for difficult motor driven loads like compressors and pumps that require higher Locked Rotor Current during startup.
- If the power drawn by the load exceeds the above surge ratings, the inverter protects itself by limiting the load current to 300% / 200% which results in reduction of output voltage and consequent reduction in load current. The output voltage recovers automatically when power drawn by the load drops below the above surge limits

Power Boost up to 150%: Higher percentage of rated power can be provided for limited time periods as follows:

- 150% for 5 sec
- 140% for 30 sec
- 120% for 5 min
- 110% for 30 min

4.4 DIRECT DUAL AC INPUT ARCHITECTURE

For higher reliability and redundancy, direct AC input from Grid and Generator can be fed simultaneously to separate AC Input Circuits. Only one AC source is selected at one time. When both Grid and Generator are available simultaneously, Grid is given priority. Transfer from Grid to Generator or from Generator to Grid is always routed through the inverter. Please see details under “Synchronized Transfer of Power”.

4.5 TRANSFER RELAY SECTION

Transfer Relay Section is used to either feed AC power to the Battery Charger Section and at the same time, pass through the AC power from the external AC input power source to the load (As long as the external AC input power from Grid/Generator is available and is within the programmed limits of voltage and frequency) or to transfer the load to the Inverter Section (In case of loss of the external AC input power source or if this source is not within the programmed limits of voltage and frequency). Typical transfer time is 16 milliseconds from Grid/Generator to Inverter and <1ms from Inverter to Grid/Generator. Heavy duty 70A (2x35A in parallel), Transfer Relay is used for reliable transfer of up to 300% surge power and for Neutral to Ground Bond Switching (40A rated for EVO-2212 and EVO-2224).

SECTION 4 | General Description & Principles of Operations

4.5.1 AC Transfer and Output Neutral To Chassis Ground Bond Switching

As required by NEC and UL specification 458, AUTOMATIC Output Neutral to Chassis Ground bond switching arrangement has been provided in these units through "Output Neutral to Chassis Ground Bond Switching Relay" [K4 in Figs 4.1(a) and 4.1(b)] to switch bonding of the Neutral Output Connector of the Inverter Charger as follows:

- When operating as an inverter, the current carrying conductor of the Inverter Section that is connected to the Output Neutral connector of the Inverter Charger is bonded to the metal chassis of the inverter by the "Output Neutral to Chassis Ground Bond Switching Relay" [K4 in Figs 4.1(a) and 4.1(b)]. As the metal chassis of the inverter is in turn bonded to the RV Ground (chassis of the RV) or to the Boat Ground (DC Negative Grounding Bus Bar and the Main AC Grounding Bus Bar are tied together in a boat and this is called the "Boat Ground"), this current carrying conductor of the Inverter Section will become the Grounded Conductor (GC) or the Neutral of the Inverter Section.
- When in Charging Mode, the Neutral conductor of the Grid power/Generator will be connected to the Output Neutral connector of the Inverter Charger. At the same time, the "Output Neutral to Chassis Ground Bond Switching Relay" [K4 in Figs 4.1(a) and 4.1(b)] will unbond (disconnect) the Output Neutral connector of the Inverter Charger from the chassis of the Inverter Charger. This will ensure that the Grounded Conductor (GC) / Neutral of the Grid power/Generator is bonded to the Earth Ground at one single point at the location of the AC Power Distribution System of the Marina/RV Park.
- **Disabling Neutral to Ground Bond:** In some applications, the Output Neutral may be required to remain isolated from the chassis/Ground at all times. For this, automatic Output Neutral to Ground bond can be disabled by disconnecting the Male/Female Quick Disconnect located in the AC wiring compartment. [Please see (i) 13, Fig 3.9 and (ii) "QD" in Figs 4.1(a) and 4.1(b)]

Please read the following on-line White Papers for more details at www.samlexamerica.com (Home > Support > White Papers):

- "Grounded Electrical AC Power Distribution"
- "Grounding System and Lightning / Ground Fault Protection"
- "Neutral to Ground Switching in RV and Marine Applications"

4.5.2 Operation of Transfer and Output Neutral and Chassis Ground Bond Switching Relays – EVO-2212 and EVO-2224

Refer to Schematic at Fig 4.1(a)

The Bi-directional Transformer is used as follows:

- Feeds AC output from the Inverter Section when Grid / Generator power is not available.
- Feeds Grid / Generator power to the Battery Charger Section when Grid / Utility are available.

Switching of Hot Output (OUTPUT LINE)

- 40A rated SPDT Relays K2 and K3 are used to switch the Hot Output Connector (**OUTPUT LINE**) to either the Inverter Section or to the Grid / Generator
- When Grid / Generator Power is available, relays K2 or K3 will be energized and contact 4 switches over to contact 5 (Grid has PRIORITY over Generator if both are present)

SECTION 4 | General Description & Principles of Operations

simultaneously). The Bidirectional Transformer works as a battery Charger. The Hot AC input from the Grid (GRID LINE) or from the Generator (GEN LINE) is fed to the Hot input of the Bi-directional Transformer for battery charging and at the same time, it is passed through to the Hot Out (OUTPUT LINE) for powering the AC loads

- When Grid / Generator power fails, relays K2 / K3 will be de-energized and contact 4 switches over to contact 3. Output from the Inverter Section is fed to the Bi-directional Transformer and onwards to the Hot Out (OUTPUT LINE) for powering the AC loads

Switching of Output Neutral to Chassis Ground Bonding

- 40A rated SPDT Relay K4 is used to switch the bonding of the Output Neutral Connector (OUTPUT NEUTRAL) to the chassis of the unit
- When Grid / Generator Power is available, relay K4 will be energized and contact 4 switches over to contact 5. Neutral input from the Grid (GRID NEUTRAL) or from the Generator (GEN NEUTRAL) is fed to the Neutral input of the Bi-directional Transformer for battery charging and at the same time, it is passed through to the Output Neutral (OUTPUT NEUTRAL) for powering the AC loads. Please note that in this condition, the Output Neutral (OUTPUT NEUTRAL) is isolated from the chassis of the unit
- When Grid / Generator power fails, relay K4 will be de-energized and contact 4 switches over to contact 3. Neutral output from the Inverter Section is fed the Neutral of the Bi-directional Transformer and onwards to the output Neutral (OUTPUT NEUTRAL) for powering the AC loads. At the same time, the output Neutral (OUTPUT NEUTRAL) gets bonded to the chassis of the unit through the mated contacts of the Insulated Quick Disconnect "QD" located in the AC Wiring Compartment (13, Fig 3.9)

4.5.3 Operation of Transfer and Output Neutral to Chassis Ground Bond Switching Relays – EVO-3012 and EVO-4024

Refer to Schematic at Fig 4.1(b)

The Bi-directional Transformer is used as follows:

- Feeds AC output from the Inverter Section when Grid / Generator power is not available.
- Feeds Grid / Generator power to the Battery Charger Section when Grid / Utility are available.

Switching of Hot Output (OUTPUT LINE)

- 70A rated DPDT Relays K2 and K3 are used to switch the Hot Output Connector (**OUTPUT LINE**) to either the Inverter Section or to the Grid / Generator. Please note that in this relay, each of the 2 poles is rated for 35A. The 2 poles are used in parallel to increase the contact current carrying capacity to 70A.
- When Grid / Generator Power is available, relays K2 or K3 will be energized and contacts 7 and 9 will switch over to contacts 4 and 6 respectively (Grid has PRIORITY over Generator if both are present simultaneously). The Bidirectional Transformer works as a battery Charger. The Hot AC input from the Grid (GRID LINE) or from the Generator (GEN LINE) is fed to the Hot input of the Bi-directional Transformer for battery charging and at the same time, it is passed through to the Hot Out (OUTPUT LINE) for powering the AC loads
- When Grid / Generator power fails, relays K2 / K3 will be de-energized and contacts 7 and 9 will switch over to contacts 1 and 3 respectively. Output from the Inverter Section is fed the Bi-directional Transformer and onwards to the Hot Out (OUTPUT LINE) for powering the AC loads

SECTION 4 | General Description & Principles of Operations

Switching of Output Neutral to Chassis Ground Bonding

- 70A rated DPDT Relay K4 is used to switch the bonding of the Output Neutral Connector (OUTPUT NEUTRAL) to the chassis of the unit. Please note that in this relay, each of the 2 poles is rated for 35A. The 2 poles are used in parallel to increase the contact current carrying capacity to 70A.
- When Grid / Generator Power is available, relay K4 will be energized and contacts 7 and 9 will switch over to contacts 4 and 6 respectively. Neutral input from the Grid (GRID NEUTRAL) or from the Generator (GEN NEUTRAL) is fed to the Neutral input of the Bi-directional Transformer for battery charging and at the same time, it is passed through to the output Neutral (OUTPUT NEUTRAL) for powering the AC loads. Please note that in this condition, the Output Neutral (OUTPUT NEUTRAL) is isolated from the chassis of the unit
- When Grid / Generator power fails, relay K4 will be de-energized and contacts 7 and 9 will switch over to contacts 1 and 3 respectively. Neutral output from the Inverter Section is fed the Neutral of the Bi-directional Transformer and onwards to the output Neutral (OUTPUT NEUTRAL) for powering the AC loads. At the same time, the output Neutral (OUTPUT NEUTRAL) gets bonded to the chassis of the unit through the mated contacts of the Insulated Quick Disconnect "QD" located in the AC Wiring Compartment (13, Fig 3.9)

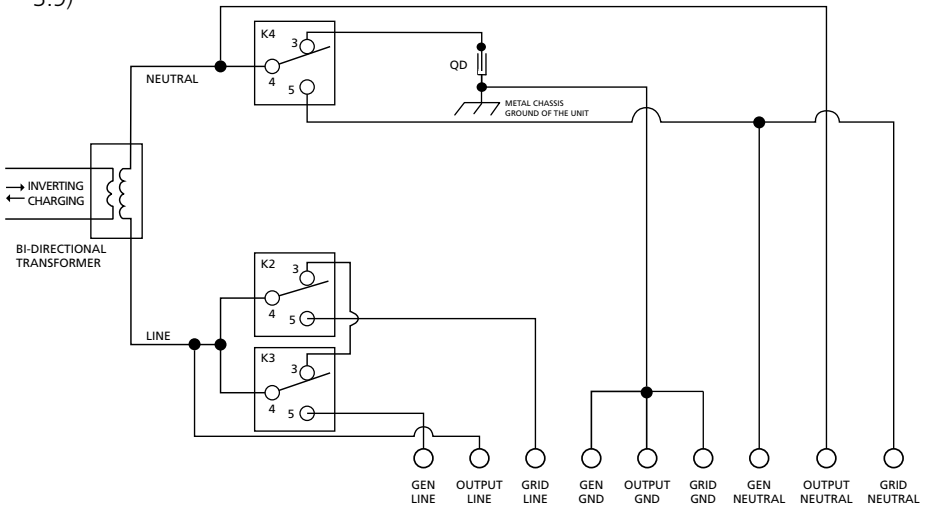

K2	Transfer Relay (40A) for Grid, Line
K3	Transfer Relay (40A) for Generator, Line
K4	Relay (40A) for Neutral to Ground bond Switching
3, 4	Normally Closed Contacts
4, 5	Normally Open Contacts
QD	Quick Disconnect (13, Fig 3.9) for disconnecting Output Neutral to Chassis Ground bond in Inverting Mode (Default - connected)
NOTE:	Relays are de-energized in Inverting Mode and are energized in Charging Mode

Fig 4.1(a) Operation of Transfer Relay and Neutral to Ground Bond Switching in EVO-2212 and EVO-2224

SECTION 4 | General Description & Principles of Operations

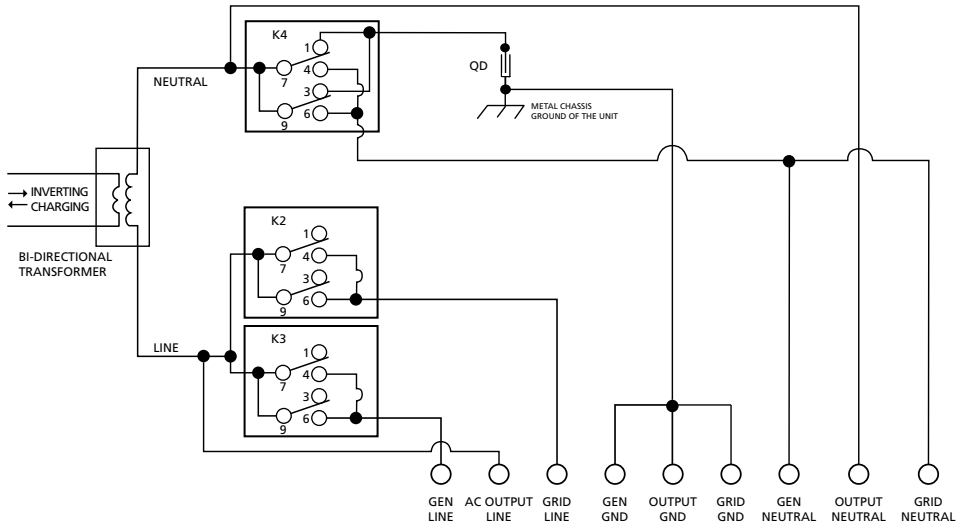

K2	DPDT Transfer Relay (70A) for Grid, Line <ul style="list-style-type: none"> Two 35A each poles are paralleled for 70A capacity
K3	DPDT Transfer Relay (70A) for Generator, Line <ul style="list-style-type: none"> Two 35A each poles are paralleled for 70A capacity
K4	DPDT Transfer Relay (70A) for Neutral to Ground Bond Switching <ul style="list-style-type: none"> Two 35A each poles are paralleled for 70A capacity
7,1 and 9,3	Normally Closed Contacts
7,4 and 9,6	Normally Open Contacts
QD	Quick Disconnect (13, Fig 3.9) for disconnecting Output Neutral to Chassis Ground bond in Inverting Mode (Default - connected)
NOTE:	Relays are de-energized in Inverting Mode and are energized in Charging Mode

Fig 4.1(b) Operation of Transfer Relay and Neutral to Ground Bond Switching in EVO-3015 and EVO-4024

4.5.4 Synchronized Transfer of Power

Direct AC input from Grid and Generator can be fed simultaneously to separate AC Input Circuits. Only one AC source is selected at one time. When both Grid and Generator are available simultaneously, Grid has priority. To facilitate synchronization, transfer of power from Grid to Generator or from Generator to Grid is always routed through the inverter.

4.5.5 Transfer From Inverter to Grid / Generator

When Grid / Generator becomes available, its voltage and frequency are checked if these are within the programmed limits. If yes, the output voltage of the Inverter Section is synchronized with Grid / Generator through Phase Locked Loop" (PLL). This synchronization process takes few seconds. Once synchronization is completed, the load is transferred instantly (within 1 ms) to Grid / Generator at Zero Crossing of the voltage waveform for seamless transfer and for better protection of Transfer Relay contacts. The unit now operates in "Charging

SECTION 4 | General Description & Principles of Operations

Mode" with the AC power from the Grid / Generator charging the batteries as well as providing power to the AC loads.

4.5.6 Transfer From Grid / Generator to Inverter

When the unit is operating in "Charging Mode" with the AC power from the Grid / Generator charging the batteries as well as providing power to the AC loads, the phase and frequency of Grid / Generator is tracked continuously. In case Grid / Generator fails or is disconnected, the inverter will be forced into transfer at voltage which is at the same phase and frequency at which Grid / Generator had been disconnected. Load will be transferred to the inverter within 16ms. The unit will now work in "Inverting Mode" and the batteries will start discharging.

4.5.7 Transfer Between Grid and Generator

As discussed in "Transfer from Inverter to Grid/Generator" above, the EVO prioritizes the Grid over the Generator input. If the EVO is operating with the Generator input active and the Grid input is restored, the EVO will transfer the load to its Inverter Section, and then transfer back to the Grid input. Both operations are synchronized and the transfer is at the zero crossing for a seamless transfer.

4.6 BATTERY CHARGER SECTION

The Battery Charger Section of these units is a powerful, 3/4 Stage, fully automatic battery charging circuit. The same Isolation Transformer and the H-Bridge configuration are used to work in the reverse direction, ie. rectify the AC voltage from the Primary AC Power Source to PWM controlled low voltage DC to charge the DC Battery Source. That is why it is called a Bi-directional device. Normal 3-Stage Charging Mode consists of Bulk, Absorption and Float stages (Default). 4-Stage Equalization Mode consists of Bulk, Absorption, Equalization and Float. (The Equalization Mode is selectable). Equalization Mode is desirable for the proper health of Wet Cell Batteries. Further, the charging voltages and currents are programmable to take care of a wide range of battery types like flooded, AGM, Gel Cell, Lead Calcium, etc.

Important battery charging features are as follows:

- Adaptive Charging Control
- Dynamic Input Power Diversion Control
- Parallel charging through External Charge Controller
- Temperature compensated charging

Please see details under Section 5 titled "Battery Charging in Evolution Series".

4.7 AUTO GENERATOR START

Auto Generator Start facility is available for automatic starting of the Generator with the use of Normally Open (NO) contacts of Status Relay (14, Fig 2.1 in the EVO Manual) that close when the battery voltage drops to the programmed value of Low Volt Alarm (Default 11V / 22V) and reset (open) when the battery is recharged and its voltage rises to the programmed value of "Reset Voltage" (Default 12.5V / 25V). Please refer to programming of "Relay Function" under Section 4.8 of EVO-RC Manual at Appendix A. Relay closing and opening signal is fed to optional Generator Auto Start Stop Control Module which, in turn, is wired to the Remote Start / Stop connections on the Generator.

SECTION 4 | General Description & Principles of Operations

When the batteries discharge to the Low Voltage Alarm threshold (Default 11V / 22V), relay contact in the Status Relay will close and the Generator will be started automatically. The Inverter is synchronized with the Generator and once synchronization is completed, the load is transferred instantly (within 1 ms) to the Generator at Zero Crossing of the voltage waveform for seamless transfer and for better protection of Transfer Relay contacts. The unit now operates in "Charging Mode" with the AC power from the Generator charging the batteries as well as providing power to the AC loads. As the batteries are now being charged by the Generator, their voltage will rise and at the programmed Reset Voltage (Default 12.5 / 25V), the Status Relay will open and the Optional Generator Start / Stop Module will shut down the Generator automatically. The unit will then transfer back to "Inverting Mode". For installation details, please refer to Section 3.15 / Fig 3.13 and Section 3.16 / Fig 3.14.

4.8 MODES OF OPERATION

4.8.1 Charging Mode

As long as the external AC input power from the Grid/Generator is available and is within the programmed limits of voltage and frequency, it is passed through to the AC load through the Transfer Relay Section. At the same time, the Battery Charger Section converts the external AC input power from the Grid/Generator to DC power to charge the DC Battery Source.

4.8.2 Inverting Mode

If at any instant, the external AC input power from the Grid/Generator is interrupted or is not within the programmed limits of voltage and frequency, the Transfer Relay is de-energized and the load is transferred to the Inverter Section and internal battery charging is terminated. This is called the Inverting Mode.

4.8.3 Power Save Mode

When the unit is operating without any load connected to it, it requires some minimum input power from the battery to keep all the sections inside the unit alive and ready to deliver power to the AC load as soon as the load is switched on. This power is called the "No Load Power Draw" or the "Idle Power" or "Self Power Consumption". The "No Load Power Draw" of these units in the Normal Mode is around 25W to 30W. The EVO has a provision to minimize this "No Load Power Draw", if required (Applicable only when the unit is in "Inverter Mode"). This is achieved by enabling the "Power Saving Mode". **The unit is shipped in default "Enabled" condition i.e. Power Saving Mode will be active.** Optional Remote Control EVO-RC (see Appendix A) is required to disable this mode. When this mode is enabled, the unit does not provide continuous output power. A pulsing output power consisting of only 3 cycles of reduced 48 VAC output voltage that are made available every 0.5 seconds is used to sense if a minimum load is present or not. **As continuous power is not being supplied, the "No Load Power Draw" is reduced to less than 8W.** If a load greater than the programmed value of "Wake-up Point" is sensed, the unit exits Power Save Mode and starts providing normal continuous output power. If the load drops to the programmed value of "Enter Point", the unit once again reverts to Power Saving Mode. Programmable and Default Values of "Enter Point" and "Wake-up Point" are shown in Table 6.6. Further details are available in the Owners Manual for the Remote Control EVO-RC (See Appendix A).

Power Saving Mode should be disabled for the following loads:

- Low power loads that draw < 5W e.g. digital clocks, satellite receivers, phones / answering machines etc.
- Audio / video / computing devices that consume normal operating power > 50 W but draw less than 5W on entering Sleep Mode when switched off or when no activity is seen for a specified time.

SECTION 4 | General Description & Principles of Operations

4.8.4 Power Saving Mode - Transfer Characteristics in Grid / Generator Mode

- **Transfer from Grid / Generator to Inverter:** If qualified Grid or Generator AC input power is available (its voltage and frequency are within the programmed range), the Transfer Relay remains energized and the AC input power is passed through to the load and at the same time, the unit operates as a battery charger. If AC input power from Grid / Generator fails or is not qualified (its voltage and frequency are not within the programmed range), the Transfer Relay is de-energized and the load is transferred to the inverter. When this transfer takes place, the inverter initially operates in Normal Mode. If the AC load was greater than the programmed value of "Wake-up Point", the inverter continues in Normal Mode. However, if it sees a load less than the programmed value of "Enter Point" for around 5 sec, it enters Power Saving Mode.
- **Transfer from Inverter to Grid / Generator:** As soon as qualified AC input power from Grid / Generator is available, the inverter will exit Power Saving Mode and will switch over to Normal Mode. This switch over is necessary for synchronizing the AC output of the inverter with the AC input before transfer (Synchronization can not be carried out with pulsing wave form during Power Saving Mode). After synchronization is completed, the load is transferred to the Grid/Generator at zero crossing of the voltage waveform.

4.8.5 Off-Line/On-Line Modes

The unit is able to operate in two modes – Off-Line Mode (Default) and On-Line Mode. Off-Line Mode is the Default Mode. Mode can be changed to On-Line Mode through optional Remote Control Model EVO-RC (Please see Section 4.4 in the attached Owner's Manual for EVO-RC – Appendix A)

- **Off-line Mode (Default Mode):** In this Mode, PRIORITY is given to the AC input fed from the Grid / Generator Inputs. This is the Default Mode.

If qualified AC input (within the programmed voltage and frequency limits) is available at the Grid / Generator AC inputs, Transfer Relay energizes and the unit operates in "Charging Mode" and qualified AC input from the Grid / Generator is passed through to the AC Output and at the same time, the Internal AC Charger starts charging the battery. If an external charger is also connected to the External Charging Terminals, the internal AC Charger will limit the charging current to a value = (Programmed Value of Charging Current - Value of Current fed from the External Charger). When the Grid / Generator AC input fails or is not within the programmed value of voltage and frequency, the Transfer Relay is de-energized, the unit changes over to "Inverting Mode" and the AC Output is fed from the internal Inverter Section. When Grid / Generator input is restored, the unit reverts back to "Charging Mode".
- **Online Mode:** In this mode, PRIORITY is given to the Inverter Section. This mode has to be programmed through the optional Remote Control EVO-RC. Please see details at Section 4.4 of the attached Owner's Manual for EVO-RC (Appendix-A).

Even if qualified AC input (within the programmed voltage and frequency limits) is available at the Grid / Generator AC inputs, the unit always operates in "Inverting Mode" and AC output is provided by the Inverter Section as long as the battery is in charged condition above the "LOW VOLT ALARM" threshold. When the battery discharges to the programmed value of "LOW VOLT ALARM" threshold [**12V Version:** 9.50V to 12.50V (Default 11.0V); **24V Version:** 19.00V to 25.00V (Default 22.00V)], Transfer Relay energizes and the unit changes over to "Charging Mode" and qualified AC input from the Grid / Generator is passed through to the AC Output and at the same time, the Internal

SECTION 4 | General Description & Principles of Operations

AC Charger starts charging the battery. If an external charger is also connected to the External Charging Terminals, the internal AC Charger will limit the charging current to a value = (Programmed Value of Charging Current - Value of Current fed from the External Charger). When the battery voltage rises to the programmed value of "RECONNECT VOLTAGE" [**12V Version:** 13.50V to 16.00V (Default 14.0V); **24V Version:** 27.00V to 32.00V (Default 27.6V)], the Transfer Relay is de-energized, the unit changes over to "Inverting Mode" and the AC Output is fed from the internal Inverter Section

This mode is preferred in solar applications where Grid / Generator backup power is available but the primary source of power is batteries that are charged through Solar Panels / Charge Controller. The Inverter Section of EVO Inverter Charger will provide AC power most of the time and AC power from the Grid / Generator will be drawn to charge the batteries only when the batteries are discharged to Low Voltage Alarm Threshold due to excessive load or due to long cloudy periods. This application is desirable in areas where Grid/Utility Energy Rates are high and use of solar power is more cost effective.

4.9 TEMPERATURE SENSOR FOR BATTERY CHARGING

Battery Temperature Sensor Model EVO-BCTS (Fig 2.5) has been provided to ensure optimum charging by modifying the charging voltages based on temperature if the battery sees very wide temperature swings. Temperature compensation can be programmed with the help of optional Remote Control EVO-RC (see Appendix A). Range is -3 to -4 mv/ °C/cell (Default is -4 mv/ °C/cell). Without temperature compensation, the battery life is likely to be drastically reduced because the battery will be undercharged during cold conditions (will build up sulfation) or will be overcharged during hot conditions (will boil and lose excessive water). **Please read White Paper titled "Batteries, Chargers & Alternators" available online at www.samlexamerica.com (Home > Support > White Papers) and Section 5 titled "Battery Charging in EVO Series" for more details.**

4.10 PARALLEL OPERATION WITH EXTERNAL CHARGER

The Battery Charger Section is able to operate in parallel with another external charging source like Solar Charge Controller / AC charger with a charging capacity of up to 50 A. The output of the external charging source is routed through this unit and operates in parallel with the internal charger. The internal charging current is controlled to ensure that the combined current fed to the battery does not exceed the programmed Bulk Charging Current. This improves the life of the battery.

4.11 COOLING FANS AND OVER TEMPERATURE PROTECTION

The unit is cooled by convection and by forced air cooling using 2 variable speed cooling fans. Temperature is sensed at 5 points (Power Transformer, 2 points for H-Bridge Power Mosfets, Heat Sink and Low Voltage Bus Bar). The fans will be switched ON at specified temperatures measured at the above sense points. The speed of the fans is increased as the temperature rises. The unit will shut down due to over temperature if the sensed temperature rises above the specified overheat thresholds. It will reset automatically after the unit has cooled down to the Reset Threshold.

SECTION 4 | General Description & Principles of Operations

4.12 OPTIONAL REMOTE CONTROL EVO-RC FOR PROGRAMMING OF MODES OF OPERATION AND PARAMETERS

Optional Remote Control Model EVO-RC (Fig 2.4) will be required for more advanced control and monitoring. Please see separate Owner's Manual for EVO-RC at Appendix A. The Remote Control comes with 10M / 33 ft., RJ-45 Data Cable. The Remote plugs into RJ-45 Jack on the front panel of the unit (7, Fig 2.1). It has provision for Data Logging using SD Card of up to 16 GB (FAT16 / FAT32). It also has its own Real Time Clock and Super Capacitor Type of Internal Battery. The Remote Control will be required for Firmware upgrade through the SD Card.

Detailed messaging is available through its LCD display and LEDs. This remote will also be required for programming of various parameters to suit specific requirements. Each programmable parameter has a Default Value. **This unit has been shipped with the various parameters set at the Default Values. Programmable and Default values are shown in Tables 6.2 to 6.6.**

SECTION 5 | Battery Charging in Evolution Series



INFO

For background information on batteries and charging process, please read Section 1.4, "General Information - Lead Acid Batteries". All battery charging voltages are specified at battery temperature of 25°C / 77°F.

5.1 PRINCIPLE OF OPERATION OF BATTERY CHARGING SECTION

EVO Series is a Bi-directional Inverter / Charger with a Transfer Relay that operates either as an inverter OR as a battery charger. It uses a common Converter Section that can work in two directions – in one direction it converts external AC power to DC power to charge the batteries (Charging Mode) and in the other direction, it converts the DC power from the battery to AC power (Inverting Mode). PWM design is used for both the charging and inverting sections. Please note that it cannot work in both the directions at the same time (i.e. it cannot work as an inverter and as a charger at the same time).

When AC input power from Grid / Generator is available within the programmed limits of voltage and frequency, the internal Transfer Relay passes through the AC input to the AC loads and at the same time, the AC input is fed to the Battery Charger Section.

First, the AC input voltage is stepped down by the Low Frequency Isolation Transformer and is then rectified by 4 sets of H-Bridge Mosfets and fed to the batteries for charging. When charging starts, the current does not rise sharply, but ramps up slowly to the full programmed Bulk Charge current.

The Battery Charger Section of the EVO is a powerful, 100 MHz DSP micro-controller based, 3 Stage or a 4 Stage Charger. Battery charging parameters are detailed at Table 5.1.

3 Stage Charging Algorithm (Default) is used for normal day to day charging. The 3 stages are – Bulk, Absorption and Float. The charging voltages and currents are programmable within the ranges given in the Table 5.1 to take care of a wide range of battery types like flooded, AGM, Gel Cell, Lead Calcium etc. For details, see Section 5.6 and Charging Curves at Fig 5.1.

4 Stage Charging Algorithm is used in the Equalization Mode. Equalization Mode is selected using optional Remote Control EVO-RC (see Appendix A). This mode is used only for Flooded or Wet Cell batteries. The 4 stages will be - Bulk, Absorption, Equalization and Float. For details, see Section 5.7 and Charging Curves at Fig 5.2. Equalization Mode is desirable for the proper health of Wet Cell Batteries. Equalization voltage is programmable. Equalization current and Equalization time are computed automatically. Please see Table 5.1 for details.

5.2 DYNAMIC INPUT POWER DIVERSION CONTROL OF BATTERY CHARGING CURRENT

In Charging Mode, the net AC input current from the Grid / Generator is the sum of the AC side charging current and the pass through load current. Based on the rated capacity of the Grid Branch Circuit / Generator, the net AC input current will be required to be limited to prevent overloading of the Grid Branch Circuit / Generator.

EVO Series has a very powerful battery charger that will require a proportionate higher AC input current from the Grid/Generator. The Grid Branch Circuit/Generator will also be required to provide current to the AC loads. With the optional Remote Control Model EVO-RC, the desired

SECTION 5 | Battery Charging in Evolution Series

value of input current from Grid/Generator can be programmed (See Appendix A under Group 2 Parameter Select for Input Setting-"Max Current". Default is 30A). The EVO will automatically reduce charging current to support the AC loads on priority and use whatever is extra for charging. This will prevent overloading of the Grid Branch Circuit/Generator.

5.3 ADAPTIVE CHARGING CONTROL FOR COMPLETE CHARGING AND PREVENTION OF OVER CHARGING / BOILING OF BATTERIES

An automatic Adaptive Charging Algorithm is used to ensure that the battery is completely charged in a safe manner for longer battery life. In this algorithm, the time the battery remains in Absorption and Equalization Stages is proportional to the time the battery remains in the Bulk Charge Stage. A battery that is deeply discharged will remain in Bulk Stage for a longer duration and will require longer time in the Absorption and Equalization Stages for complete charging. On the other hand, a battery that is almost completely charged will remain in the Bulk Stage for a shorter duration and consequently, will remain in Absorption and Equalization stages for a shorter duration. This will prevent overcharging / boiling of the battery.

Note: In other inverter chargers that execute Absorption and Equalization Stages for a fixed time of 4 to 8 Hours, a nearly fully charged battery may overcharge / boil and hence, will reduce battery life.

5.4 PARALLEL CHARGING OF BATTERIES THROUGH EXTERNAL CHARGER

The Battery Charger Section is able to operate in parallel with another external charging source like Solar Charge Controller / AC Charger of up to 50A capacity. The output of the external charging source is routed through the unit (Connectors 3, 4 in Fig 2.1). Maximum charging current from the external charging source is limited to 50A .This limit should not be exceeded! Please note that Lead Acid batteries should not be charged at very high charging currents to prevent adverse effects like reduction in returned capacity, excessive surface charge, overheating, excessive pressure build up in sealed batteries (generation of Oxygen and Hydrogen will be > recombination) etc. Normally, the maximum charging current is limited to 20% of the Ah capacity of the battery unless the battery manufacturer allows higher charging current. When a battery is charged simultaneously by multiple charging sources, all the charging currents will add up and may result in very high charging current with respect to the Ah capacity of the battery.

The charging current fed from the external source is measured and the charging current generated by the internal charger is automatically controlled to ensure that the net charging current fed to the battery does not exceed the net programmed Bulk Charge Current "I_o".

5.5 Battery Temperature Sensor

A Battery Temperature Sensor Model EVO-BCTS has been provided [Fig 2.5(a)]. It comes with 5 m / 16.5 ft cable. Connect the ring terminal end (houses the sensor) on the battery Positive or Negative post. Connect the RJ-45 plug to the Temperature Sensor Jack (6, Fig. 2.1). The Temperature Sensor is used to ensure optimum charging by modifying the charging voltages based on temperature if the battery sees very wide temperature swings. In addition to compensating the charging voltages, the thresholds of "LOW VOLT ALARM", "BATT LOW VOLTAGE" shut down, "RESET VOLTAGE" and "BATTERY OVER VOLT" are also temperature compensated. Temperature compensation will be carried out over a temperature range of -20°C to + 60°C.

SECTION 5 | Battery Charging in Evolution Series

Table 5.1 shows the programmable range. Default settings for the temperature coefficient is $-4\text{mV}/^\circ\text{C}/\text{Cell}$.

5.6 3 STAGE CHARGING MODE: BULK, ABSORPTION & FLOAT FOR NORMAL CHARGING

Normal day to day charging is performed in a 3 Stage Cycle—BULK, ABSORPTION and FLOAT—to provide rapid and complete charge cycles without undue battery gassing. Please see Table 6.2 for details of programmable settings and Default Values. This 3 Stage Charging is the Default Charging Mode.

Fig. 5.1 shows the voltage and current charging curves with respect to time and different charging stages.

NOTE: With the optional Remote Control Model EVO-RC (see Appendix A), it is possible to program and activate 4 Stage Charging Mode including the 4th Equalization Stage. 4-Stage charging is required to be carried out only on flooded / wet cell batteries. This 4 Stage Charging Mode is discussed separately under “4 Stage Charging Mode in Equalization Mode” at Section 5.7.

5.6.1 Bulk Charge Stage

In the first stage, known as the Bulk Charge Stage, the charger delivers the maximum Bulk Charge Current “ I_o ” that has been programmed through the “Parameter Setting Menu” of the optional Remote Control Model EVO-RC. Range and Default value are shown at Table 5.1. This current is delivered to the batteries until the battery voltage approaches its Gassing Voltage (Absorption Voltage)—typically around 14.4 volts for 12 volt batteries and 28.8 volts for 24 volt batteries (again, this voltage can vary based upon the desired values programmed through the “Parameter Setting Menu” of the optional Remote Control Model EVO-RC (see Appendix A)). The Bulk Charge Stage restores about 75% of the battery’s charge. The Gassing Voltage is the voltage at which the electrolyte in the battery begins to break down into Hydrogen and Oxygen gases. Under normal circumstances, a battery should not be charged at a voltage above its Gassing Voltage (except in the manually selected Equalization Stage) since this will cause the battery to lose electrolyte and dry out over time.

This stage is displayed as “N-CC” in the Charging Mode screens in the Remote Control EVO-RC (Fig 3.2, Appendix A).

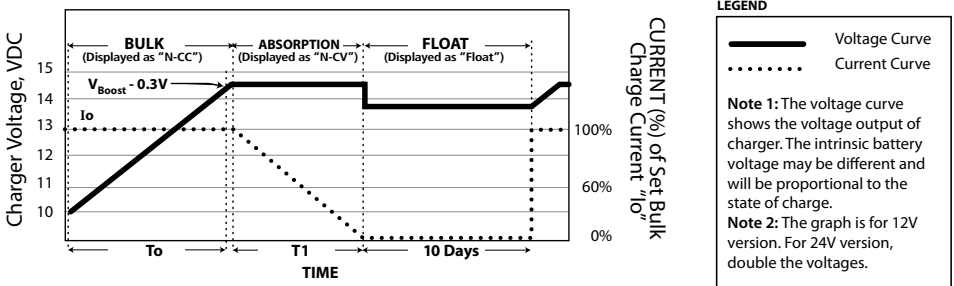

Fig 5.1 Charging Curve for Normal 3 Stage Charging

SECTION 5 | Battery Charging in Evolution Series

The value of the Bulk Charge Current “Io” depends upon the total Ampere Hour (Ah) capacity of the battery or bank of batteries. A battery should never be charged at very high charging current as very high rate of charging will not return the full 100 percent capacity as the Gassing Voltage rises with higher charging current. **As a general Rule of Thumb, the Bulk Charging Current “Io” should be limited to 10% to 20% of the Ah capacity of the battery (20 Hr Rate).** Higher charging current may be used if permitted by the battery manufacturer.

Programmable range and Default values of Bulk Charge Current “Io” are shown in Table 6.2. The units are shipped with the Bulk Charge Current set at the Default Value of 40A.

When the unit enters Charging Mode, it starts working as a battery charger and the charger will run at full programmed Bulk Charge Current until the charger reaches the programmed Absorption Voltage.

As part of the Adaptive Charging Algorithm, a software timer will measure the time taken from the instant the unit enters the Charging Mode until the instant the battery voltage reaches 0.3V below the programmed Absorption Voltage, then registers this time as Bulk Charge Time To and computes the Absorption Time T1 as 10 times the Bulk Charge Time To in the internal “T1 Timer” i.e. $T1 = To \times 10$. The “T1 Timer” is used to determine the time the charging will take place in the next Absorption Stage.

5.6.1.1 Automatic Adjustments of Internal AC Charger Current When External Charger is Also Charging in Parallel

Please note that if an external charging source is also used to charge the batteries at the same time in parallel with the internal AC charger of the unit, the charging current of the internal AC charger will be controlled so that the total charging current of the external charger and the internal charger is = the programmed Bulk Charging Current “Io”.

For example, if the programmed charging current is say 40A and the charging current of the external charger is 30A, the internal AC charger will output only 10A (Programmed setting of 40A – external charging current of 30A = 10A). Similarly, if the programmed setting is say 30A and the external charger is 50A, the internal AC charger will not provide any charging.

5.6.2 Absorption Stage

During the Absorption Stage, the charging voltage is held constant near the Gassing Voltage to ensure that the battery is further charged to the full capacity without overcharging. The Absorption Stage restores the remaining 25% of the battery’s charge. The time the charger remains in the Absorption Stage is proportional to the depth of discharge of the battery. When the battery is more discharged, it will take longer time in the Bulk Charge Stage to reach the Gassing Voltage. As a part of the Adaptive Charging Algorithm, the “T1 Timer” (explained above) computes the time the charging takes place in this stage.

- The “T1 Timer” has minimum time of 1 hour and a maximum time of 12 hours.
- When the T1 Timer runs out, the charger will enter the next Float Stage.
- Programmable range and Default values of Absorption Voltage are shown in Table 5.1.

This stage is displayed as “N-CV” in the Charging Mode screens in the Remote Control EVO-RC (Appendix A).

SECTION 5 | Battery Charging in Evolution Series

5.6.3 Float Stage

Float Stage is a maintenance stage in which the output voltage is reduced to a lower level, typically about 13.5 volts, (27 volts for 24V models) to maintain the battery's charge without losing electrolyte through gassing and also prevent corrosion of Positive plate by maintaining proper Positive plate Polarization Voltage. Programmable range value of Float Voltage are shown in Table 6.2.

This stage is displayed as "Float" in the Charging Mode screens in the Remote Control EVO-RC (Appendix A).

5.6.4 Automatic Resetting of Charging Cycle in 3 Stage Charging Profile

The charging cycle will be reset to the Bulk Stage as follows:

- If the AC input from the Grid/Generator is disconnected and is reconnected or the battery voltage drops below 12 VDC / 24 VDC (Default). Programmable range for this voltage is 10 to 13V for 12V battery and 20 to 26V for 24V battery.
- If the charger remains in the Float Mode for 10 days.

5.7 4 STAGE CHARGING IN EQUALIZATION MODE



CAUTION!

Equalization Mode should be performed only on vented, flooded (non-sealed or "wet") batteries and not on the sealed AGM / Gel Cell batteries and only as often as recommended by the battery manufacturer.



ATTENTION!

La mode d'égalisation devrait être faite sur des batteries ventilées, inondées (batteries non-scellées ou «mouillées») et pas sur des batteries scellées (AGM) ou cellules gelées et, aussi souvent que les recommandations du fabricant.

4 Stage Battery Charging Cycle is used in the Equalization Mode. Equalization Mode is selected using optional Remote Control EVO-RC (see Appendix A). Equalization of the batteries is carried out periodically - normally once per month for battery under heavy duty service and every two to four months for battery under light duty service. As equalization is a deliberate over-charge of the battery for a specified time period, equalizing your flooded / wet cell batteries will reduce sulfation, stir up the electrolyte to remove stratification, equalize voltages of individual cells and thus, help reach and maintain the peak capacity of the battery.

Please read about the necessity and details of equalizing batteries under White Paper titled "Batteries, Chargers and Alternators," available online at www.samlexamerica.com (Home > Support > White Papers).

The 4 stages of the cycle will be - Bulk, Absorption, Equalization, and Float. Equalization Mode is desirable for the proper health of Wet Cell Batteries. Equalization voltage is programmable through the optional Remote Control Model EVO-RC (see Appendix A). Programmable voltage range and default values are shown in Table 6.2.

Equalization current and Equalization time are computed automatically. (See Section 5.8)

Fig 5.2 shows the voltage and current curves during the 4 stages of charging in this mode.

SECTION 5 | Battery Charging in Evolution Series

When Equalization is selected (requires optional Remote Control Model EVO-RC (see Appendix A), the charger will first execute Bulk Stage followed by Absorption Stage. On completion of Absorption Stage, the charger will execute Equalization Stage. After completion of Equalization Stage, the charger will enter Float Stage. The stage transitions will thus be: Bulk Stage (Constant Current) → Absorption stage (Constant Voltage) → Equalization Stage (Constant Voltage) → Float Stage (Constant Voltage).

As part of the **Adaptive Charging Algorithm**, the charging profile in the Equalization Stage is based on the time T_0 which is the time the charger remains in the initial Bulk Stage. The charger will remain in the initial Bulk Stage for a longer duration when the battery is deeply discharged and for a shorter duration if the battery has a shallow discharge.

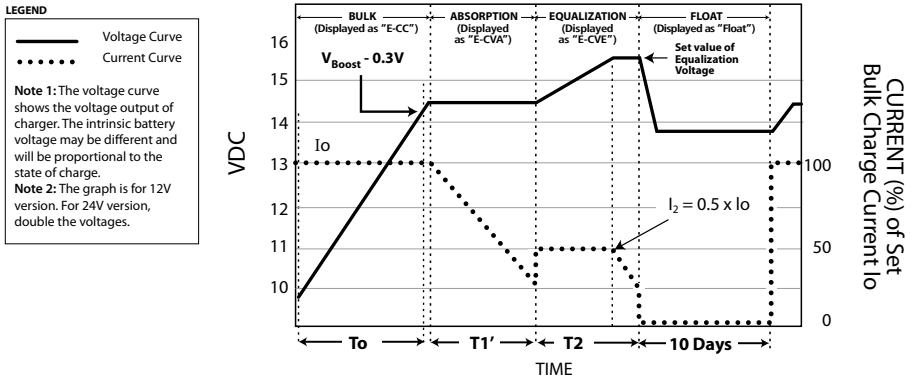

Fig 5.2 Charging Curve for 4 Stage Charging in Equalization Mode



CAUTION!

For effective equalization to take place, it is desirable that the batteries undergo a longer Bulk Stage applicable to the deeply discharged condition of the battery.

- Please ensure that before the batteries are equalized, they should be deeply discharged to 20% of its capacity. The Standing Voltage (Terminal Voltage after disconnecting charging source[s] and load[s] for at least 3 hours) at 20% capacity will be:
 - 12V Battery: Around 11.7V
 - 24V Battery: Around 23.4V
- Do not equalize partially or fully charged batteries



ATTENTION!

Pour une *égalisation* efficace, il faut que les batteries subissent à une *étape* majeure plus long en fonction de la condition déchargée de la batterie.

- Veuillez assurer que les batteries sont profondément déchargées (à 20% de sa capacité), avant de les égaliser. La tension constante (la tension de la borne après avoir déconnecter toutes sources de charge pour un minimum de 3 heures) quand elles sont déchargées à 20% de sa capacité, serait:
 - Une batterie de 12V: Environ 11,7V
 - Une batterie de 24V: Environ 23,4V
- N'égalisez pas des batteries qui sont partiellement ou complètement chargées

SECTION 5 | Battery Charging in Evolution Series

5.8 DETAILS OF EQUALIZATION MODE CHARGING CYCLE (Fig 5.2)

- During the Bulk Stage, the charger will charge at the programmed Bulk Charge Current “ I_o ” (see programmable range at Table 5.1. Default value is 40A). Bulk Charge Current “ I_o ” is normally limited to 10%-20% of the Ah capacity of the battery (20Hr Rate). Higher current may be used if permitted by the battery manufacturer in Equalization Mode. **The Bulk Stage is displayed as "E-CC" in the Charging Mode screens of the optional Remote Control EVO-RC (Appendix A).**
- A Software Timer is used to measure the time taken from the time the unit transfers to the Utility / Generator Mode until the battery charger reaches 0.3V below the Absorption Voltage, then registered this time as time T_o . The following times are computed based on the time T_o :
 - Absorption Time $T1' = T_o \times 0.5$
 - Equalization Time $T2$ is then computed based on the following logic:
 - $T2 = T1' + 1 \text{ hr} = 0.5 T_o + 1 \text{ hr}$; if $T1' < 2 \text{ hrs}$
 - $T2 = T1' + 2 \text{ hrs} = 0.5 T_o + 2 \text{ hrs}$; if $2 < T1' < 4 \text{ hrs}$
 - $T2 = T1' + 4 \text{ hrs} = 0.5 T_o + 4 \text{ hrs}$; if $T1' > 4 \text{ hrs}$
- When the battery reaches the programmed Absorption Voltage (see programmable range and defaults at Table 5.1), it transitions to the Absorption Stage and remains in this stage for the computed time $T1'$. **This stage is displayed as "E-CVA" in the Charging Mode screens in Remote Control EVO-RC (Appendix A).**
- At the end of Absorption Stage, it transitions to the programmed Equalization Voltage (see programmable range and defaults at Table 5.1). It remains in this stage for the computed time $T2$. **This stage is displayed as "E-CVE" in the Charging Mode screens in Remote Control EVO-RC (Appendix A).**
- The equalization current “ I_2 ” is normally 5% to 10% of the Ah capacity of the battery. This current is indirectly computed from the programmed Bulk Charge Current. **As recommended under the Setting Mode for the Bulk Charge Current, the Bulk Charge Current “ I_o ” is expected to be set at 10% to 20% of the Ah capacity of the battery.** Hence, the Equalization current “ I_2 ” will be automatically computed at 50% of the set Bulk Charge Current “ I_o ” which will effectively amount to 5% to 10% of the Ah capacity of the battery. For example, the Equalization Current “ I_2 ” for a 200 Ah capacity battery will be 10 A - 20A. The Bulk Charge current “ I_o ” for a 200 Ah capacity at 10% - 20% will be set at 20 A - 40A. The firmware will compute the Equalization Current “ I_2 ” at 50% of 20 A (i.e. 10A) or at 50% of 40A (i.e. 20A).
- At the end of Equalization Stage, the charger transitions to the programmed Float Voltage (see programmable range and defaults at Table 5.1). **This stage is displayed as "Float" in the Charging Mode screens in Remote Control EVO-RC (Appendix A).**

Automatic Resetting of Charging Cycle

The charging cycle will be reset to the Bulk Stage of 3 Stage Charging Profile as follows:

- If the AC is reconnected or the battery voltage drops below 12 VDC / 24 VDC (Default). Programmable range for this voltage is 10 to 13V for 12V battery and 20 to 26V for 24V battery.
- If the charger remains in the Float Mode for 10 days.

SECTION 5 | Battery Charging in Evolution Series

5.9 SWITCHING ON AND SWITCHING OFF OF EQUALIZATION MODE (4 STAGE CHARGING)

The unit comes preset for charging in Normal Charging Profile (3 Stage Charging Profile). Equalization Profile (4 Stage Charging Profile) is required to be selected manually as follows:

Using ON/OFF Push Button on the Front Panel: When the unit is in Charging Mode (qualified Grid / Generator Input is available), the Green LED "Status" will be flashing once per second. Press the ON/OFF Button for 1 second. The ongoing Normal Charging Mode will be terminated and Equalization Mode will be initiated. The Green "Status" LED will start flashing 2 times per sec to show that Equalization Mode is active. The unit will complete Equalization Cycle and terminate in Float Stage. At the same time, the Charge Mode Setting will again reset to Normal Mode and the Green LED "Status" will return to 1 flash per second. To terminate Equalization Mode prematurely before its completion, press the ON/OFF Push Button for 1 second.

If the unit was in Inverting Mode (Green LED "Status" steady) and the Mode is set to Equalization as above by pressing the ON/OFF Push Button for 1 second, the unit will undergo Equalization Mode whenever qualified AC input is available from Grid / Generator and the unit enters Charging Mode. To terminate Equalization Mode prematurely before its completion, press the ON/OFF Push Button for 1 second.

NOTE: Procedure described above is to be used when the optional Remote Control EVO-RC has NOT been plugged into the RJ-45 Remote Control Jack. Please note if the Remote Control has been plugged into the RJ-45 Jack, the above procedure cannot be activated and the ON/OFF of Equalization Mode will be controlled by the Remote Control EVO-RC.

Using Optional Remote Control EVO-RC: Please refer to the attached manual for EVO-RC at Appendix A.

SECTION 6 | Operation, Protections and Troubleshooting

BEFORE OPERATING THE UNIT, PLEASE ENSURE THAT THE UNIT HAS BEEN INSTALLED PROPERLY AS PER INSTRUCTIONS AT SECTION 3 OF THIS MANUAL.

PLEASE ENSURE THAT ALL SAFETY INSTRUCTIONS AT SECTION 1 OF THIS MANUAL ARE READ AND UNDERSTOOD BEFORE OPERATING THE UNIT.



INFO

- a) Minimum battery voltage required for initiating operation is as follows:
 - 12V units ----- Higher than 9V
 - 24V units ---- Higher than 18V
- b) Please note that this unit is designed to POWER ON AUTOMATICALLY if (i) minimum battery voltage of 9V/18V as at (a) above is available at the DC input terminals and (ii) AC voltage > 60VAC is available at the Grid / Generator Input Terminals. If the AC input voltage and frequency are within the programmed limits, the unit will automatically operate in "Charging Mode". If the AC input voltage and frequency are not within the programmed limits, the unit will operate in "Discharging / Inverter Mode". Further, as long as AC input voltage > 60VAC is present, the unit CANNOT BE POWERED OFF using the ON / OFF Button on the front panel of the unit or on the optional Remote Control EVO-RC (see Appendix A). Switch OFF the AC input first if the unit is required to be powered off. However, if the unit is in "Fault Mode", it will be possible to power OFF the unit with the help of the ON/OFF Push Button
- c) Before proceeding, confirm that the unit is NOT in Standby Mode by pressing ON/OFF Button briefly. (Standby Mode is used for Firmware upload through the optional Remote Control EVO-RC (see Appendix A))
 - If LED marked "ON" (12, Fig 2.1) stays OFF, then unit is OFF.
 - If this LED is ON or is flashing, the unit was in Standby Mode and is now ON

6.1 POWERING ON USING ON/OFF BUTTON ON THE FRONT PANEL (11, Fig 2.1)

6.1.1 Powering ON

To power ON the unit, press and hold the ON/OFF Button **for 2 seconds**.

- Green LED marked "ON" (12, Fig 2.1) will flash 3 times, will go off momentarily and will then be steady Green. Subsequently, the lighting pattern of this LED will be controlled by various operating conditions given in Table 6.1

6.1.2 Powering OFF

To power OFF the unit, press and hold the ON/OFF Button **for 5 seconds**.

- Wait for the Green LED marked "ON" (12, Fig 2.1) and Red LED marked "FAULT" (13, Fig 2.1) to light steady and then release the ON/OFF Button. The unit will power OFF after the ON/OFF Button is released. (**NOTE:** Power OFF will not take place unless the Power ON/OFF Button is released)
- **NOTE:** As explained under paragraph (a) of "Info" above, as long as AC input voltage > 60VAC is present, the unit CANNOT BE POWERED OFF using the ON/OFF Button on the front panel of the unit or on the optional Remote Control EVO-RC (see Appendix A). In order to power off using the Power ON/Off Button, switch OFF the AC input first. Further, if the unit is in "Fault Mode", it will be possible to power OFF the unit with the ON/OFF Push Button.

SECTION 6 | Operation, Protections and Troubleshooting

6.2 POWERING ON / OFF BY FEEDING EXTERNAL +12V CONTROL SIGNAL TO TERMINALS MARKED "REMOTE ON/OFF" ON THE FRONT PANEL (15, FIG 2.1)

Programming option is available through the Parameter Setting Menu of the optional Remote Control Model No. EVO-RC (see Appendix A) for 2 types of external +12V control signal fed through Remote ON/OFF Terminal (15, Fig 2.1). Details of these options are given below:

6.2.1 Button Type (Default)

This type of logic is applicable when the +12V Control Signal is fed through a series connected Push Button contact. Control logic used is as follows:

- When the unit is in OFF condition, a momentary contact of the Push Button > 2 seconds will turn the unit ON.
- When the unit is in ON condition, pressing of the Push Button < 5 seconds will have no effect and the unit will continue to remain in ON condition.
- When the unit is in ON condition, pressing the Push Button > 5 seconds will turn the unit OFF.

6.2.2 Switch Type

This type of logic is applicable when the +12V Control Signal is fed through a series connected external manual Switch or through an external relay contact. Logic used is as follows:

- When the unit is in OFF condition, toggling the external manual switch to ON position or closing the external relay contact will immediately turn the unit ON.
- When the unit is in ON condition, toggling the external manual switch to OFF position for 2 seconds or opening the relay contact for 2 sec will turn the unit OFF.

CAUTION: When "Switch Type" of ON/OFF control described above is selected, the ON/OFF Button on the front panel of the unit (12, Fig 2.1) should NOT be used to turn ON or turn OFF the unit. The front panel ON/OFF Push Button will now follow the above "Switch Type" control logic wherein the unit will remain ON only as long as the Button is kept pressed and will turn OFF in 2 seconds after it is released.

6.3 OPERATIONAL INFORMATION THROUGH LEDS AND BUZZER

Table 6.1 below shows the operational states of the unit indicated by the following LEDs on the front panel of the unit and Buzzer:

- Green LED marked "ON" (12, Fig 2.1)
- Red LED marked "Fault" (13, Fig 2.1)

Optional Remote Control Model EVO-RC (see Appendix A) will be required for more detailed messaging that is available through its LCD display and LEDs. This remote will also be required for programming of various parameters to suit specific requirements.

SECTION 6 | Operation, Protections and Troubleshooting

TABLE 6.1 LED AND BUZZER INDICATIONS

Status	Green LED marked "ON" (12, Fig 2.1)	Red LED marked "Fault" (13, Fig 2.1)	Buzzer
When powered ON	Flash 3 times	Off	Off
When powered OFF	On	On	Off
Normal charging	Flash 1 time per sec	Off	Off
Equalization charging	Flash 2 times per sec	Off	Off
Inverting (Discharging)	On	Off	Beep per 3 second (Default Off)
Low battery alarm	On	Flash 1 per sec	Beep per 1 second
Power saving	Flash 1 time per 3 sec	Off	Off
Standby	Off	Off	Off
Fault	Off	On	On

6.4 OPTIONAL REMOTE CONTROL EVO-RC (see Appendix A) FOR PROGRAMMING OF MODES OF OPERATION AND PARAMETERS

Optional Remote Control Model EVO-RC (Fig 2.4) will be required for more advanced control and monitoring. Please see separate Owner's Manual for EVO-RC at Appendix A. The Remote Control comes with 10M / 33 ft., RJ-45 Data Cable. The Remote plugs into RJ-45 Jack on the front panel of the unit (7, Fig 2.1). It has provision for Data Logging using SD Card of up to 16 GB (FAT16 / FAT32). It also has its own Real Time Clock and Super Capacitor Type of Battery.

Detailed messaging is available through its LCD display and LEDs. This remote will also be required for programming of various parameters to suit specific requirements. Each programmable parameter has a Default Value. This unit has been shipped with the various parameters set at the Default Values. Programmable and Default values are shown in Tables 6.2 to 6.6 below:

SECTION 6 | Operation, Protections and Troubleshooting

TABLE 6.2 PROGRAMMABLE AND DEFAULT PARAMETERS: GROUP CHARGING CURVE

Parameter	Programming Range (Programming requires optional Remote Control Model EVO-RC)				Default			
	EVO-2212	EVO-3012	EVO-2224	EVO-4024	EVO-2212	EVO-3012	EVO-2224	EVO-4024
"BULK CURRENT" ** (Bulk Charge Current "I _o ")	0-100A	0-130A	0-70A	0-110A	40A			
"ABSORP VOLTAGE" ** (Absorption Voltage)	13.5V - 16.0V		27.0V - 32.0V		14.4V		28.8V	
"EQUALIZE VOLTAGE" ** (Equalization Voltage)	14.0V - 16.0V		28.0V - 32.0V		14.4V		28.8V	
"FLOATING VOLTAGE" ** (Float Voltage)	13.0V - 15.0V		26.0V - 30.0V		13.5V		27.0V	
"COMPENSATE" (Temperature Compensation)	-3mV to -5mV /°C/Cell				-4mV /°C/Cell			
"LOW VOLT ALARM" (Battery Low Voltage Alarm)	9.5V - 12.5V		19.0V - 25.0V		11.0V		22.0V	
"BATT LOW VOLTAGE" (Battery Low Voltage Shut Down)	>9.0V - 12.0V		>18.0V - 24.0V		10.5V		21.0V	
"LV DETECT TIME" (Low Voltage Detect Time)	0-600 sec				10 sec			
"LV CUT OFF TIME" (Low Voltage Cut Off Time)	0-7200 sec				1200 sec			
"RESET VOLTAGE" (Battery Low Voltage Reset)	12.0V - 17.0V		24.0V - 35.0V		12.5V		25.0V	
"BATT OVER VOLT" (Battery Over Voltage Shut Down)	14.0V - 17.0V		28.0V - 35.0V		16.0V		32.0V	
"CHARGE MODE" (3 or 4 Stage Charging)	Normal (3-Stage) / Equalization (4-Stage)				Normal (3-Stage)			
"ON LINE MODE"	0 = OFF		1 = ON		0 = OFF			
"RECONNECT VOLT" (For On-Line Mode)	13.50V to 16.00V		27.00V to 32.00V		14.00V		27.60V	
"FLOATING EXIT"	10.00V to 13.00V		20.00V to 26.00V		12.00V		24.00V	

SECTION 6 | Operation, Protections and Troubleshooting

TABLE 6.3 PROGRAMMABLE AND DEFAULT PARAMETERS - GROUP "INPUT SETTING"									
Group	Parameter name	Programming Range				Default value			
		EVO-2212	EVO-3012	EVO-2224	EVO-4024	EVO-2212	EVO-3012	EVO-2224	EVO-4024
INPUT SETTING	DEFAULT FREQ	50 / 60Hz				60Hz			
	MAXIMUM CURRENT	5 - 40A	5 -70A	5 -40A	5 -70A	30A			
	HIGH CUT OFF	50 - 70Hz				65Hz			
	HIGH RESET	50 - 70Hz				64Hz			
	LOW CUT OFF	40 - 60Hz				55Hz			
	LOW RESET	40 - 60Hz				56Hz			

TABLE 6.4 PROGRAMMABLE AND DEFAULT PARAMETERS - GROUP "INPUT LOW LIMIT"									
Group	Parameter name	Setting range				Default value			
		EVO-2212	EVO-3012	EVO-2224	EVO-4024	EVO-2212	EVO-3012	EVO-2224	EVO-4024
INPUT - LOW LIMIT	RESET VOLTAGE	60.0 - 200.0V				95.0V			
	CUT OFF POINT 1	60.0 - 200.0V				90.0V			
	DETECT TIME 1	0 - 2000 cycle				300 cycle			
	CUT OFF POINT 2	60.0 - 200.0V				85.0V			
	DETECT TIME 2	0 - 2000 cycle				60 cycle			
	CUT OFF POINT 3	60.0 - 200.0V				80.0V			
	DETECT TIME 3	0 - 2000 cycle				1 cycle			

TABLE 6.5 PROGRAMMABLE AND DEFAULT PARAMETERS - GROUP "INPUT HIGH LIMIT"									
Group	Parameter name	Setting range				Default value			
		EVO-2212	EVO-3012	EVO-2224	EVO-4024	EVO-2212	EVO-3012	EVO-2224	EVO-4024
INPUT - HIGH LIMIT	RESET VOLTAGE	120.0 - 350.0V				135.0V			
	CUT OFF POINT 1	120.0 - 350.0V				140.0V			
	DETECT TIME 1	0 - 2000 cycle				300 cycle			
	CUT OFF POINT 2	120.0 - 350.0V				145.0V			
	DETECT TIME 2	0 - 2000 cycle				60 cycle			
	CUT OFF POINT 3	120.0 - 350.0V				150.0V			
	DETECT TIME 3	0 - 2000 cycle				1 cycle			

SECTION 6 | Operation, Protections and Troubleshooting

TABLE 6.6 PROGRAMMABLE AND DEFAULT PARAMETERS - GROUP "OTHER FUNCTIONS"								
Parameter name	Setting range				Default Value			
	2212	3012	2224	4024	2212	3012	2224	4024
"POWER SAVING"	1 = Enable 0 = Disable				Enable			
• "ENTER POINT"	4 – 50W				6W	8W	6W	8W
• "WAKE UP POINT"	5 – 50W				7W	10W	7W	10W
"REMOTE SWITCH" • For ON /OFF control through external 12V signal fed to Remote ON / OFF terminals on the Front Panel (15, Fig 2.1)	0 = Button Type: 12V signal is fed through Push Button Type of Switch <ul style="list-style-type: none"> Pressing of Push Button > 2 sec will switch the unit ON When ON, pressing Push Button > 5 sec will turn the unit OFF 1 = Switch Type: 12V signal is fed through contacts of Toggle Type of Switch or relay contact <ul style="list-style-type: none"> ON condition (contacts closed) will turn the unit ON OFF condition (contacts open) for 2 sec will switch the unit OFF 				0 = Button Type CAUTION! ON/OFF Logic also controls the operation of the ON/OFF Button on the front panel (11, Fig 2.1). The Default setting is "Button Type". If the ON/OFF Control is changed to external "Remote Switch", it will not be possible to switch ON/OFF the EVO Inverter Charger from the front panel ON/OFF Push Button because it will work with Switch Type Logic. It will be ON only as long as the Push Button is kept pressed and will switch OFF when released.			
"RELAY FUNCTION"	0 - Relay will be ON (contacts will close) when in "Charging Mode" 1 - Relay will be ON (contacts will be closed) in Fault Mode 2 - Used for Generator Auto Start / Stop with the help of optional Generator Auto Start / Stop Module. <ul style="list-style-type: none"> Relay will be ON (contacts will close) at Low Battery Alarm Relay will be OFF (contacts will open) at Low Battery Reset. 				2 = Generator			
"COMM ID" (Communication ID for optional Remote Control EVO-RC)	1 - 255				1			
"BUZZER"	0 = OFF ; 1 = ON				1 = On			
"DISCHARGE BEEP" (Beeping in "Discharging / Inverter Mode")	0 = OFF ; 1 = ON				0 = Off			
"DEFAULT RESET"	0 = No ; 1 = YES				0 = No			
DATA LOG TIME (For Optional Remote Control EVO-RC)	0 = Disable	3 = 30 sec	6 = 10 min		1 = 1 sec			
	1 = 1 sec	4 = 60 sec						
	2 = 10 sec	5 = 5 min						
PARAMETER SAVE (For Optional Remote Control EVO-RC)	0 = No 1 = Yes				0 = No			

SECTION 6 | Operation, Protections and Troubleshooting

6.5 PROTECTIONS, FAULT MESSAGES AND TROUBLESHOOTING GUIDE

The front panel of the unit has a Red LED marked "FAULT" (13, Fig 2.1). This LED will light up (steady) when the unit registers any of the **FAULT MODE** situations shown in Table 7.1 of EVO-RC Manual at Appendix A.

Table 7.1 of EVO-RC Manual at Appendix A shows details of protections and associated Fault/Error Messages that will be displayed on the LCD screen of the optional Remote Control EVO-RC.

NOTE: If the optional Remote Control EVO-RC (see Appendix A) is not used, it may be difficult to narrow down the probable cause of the fault.

6.6 POWERING OFF THE UNIT IN FAULT MODE

If the unit is in "Fault Mode", it will be possible to power OFF the unit with the ON/OFF Push Button.

(As explained under paragraph 6.1.2, as long as AC input voltage > 60VAC is present, the unit CANNOT BE POWERED OFF using the ON / OFF Button on the front panel of the unit or on the optional Remote Control EVO-RC (see Appendix A). In order to power off using the Power ON/Off Button, switch OFF the AC input first).

6.7 12V, 100mA CAPACITY DC SOURCE FOR SIGNALING

A 12V, 100mA capacity DC source has been provided (16, Fig 2.1). This voltage may be routed through the contacts of the Status Relay (14, Fig 2.1) to feed 12V ON / OFF control signal to drive circuits of remote monitoring of the following 3 programmable conditions of operation of the unit (Refer to Table 6.6 under Relay Function).

- 0 - Relay will be ON (contacts will close) when in "Charging Mode"
- 1 - Relay will be ON (contacts will be closed) in Fault Mode
- 2 - Relay will be ON (contacts will close) at Low Battery Alarm and OFF (contacts will open) at Low Battery Reset. This option may be used for Generator Auto Start/Stop with the help of optional Generator Auto Start Module. Please see Section 4.7 for details.

SECTION 7 | Specifications

Models	EVO-2212	EVO-3012	EVO-2224	EVO-4024
INVERTER SECTION				
Output Waveform	Pure Sine Wave			
Input Battery Voltage Range	>9 - 17 VDC		>18 - 34 VDC	
Nominal AC Output Voltage	120 VAC \pm 5%			
Output Frequency	60 Hz \pm 0.1 Hz			
Total Harmonic Distortion of Pure Sine Wave Form (THD)	< 5%			
Continuous Output Power	2200 VA	3000 VA	2200 VA	4000 VA
Continuous AC Output Current	18A	25A	18A	33A
Surge Power for 1 msec	300% (6600 VA, 54A)	300% (9000VA, 75A)	300% (6600VA, 54A)	300% (12,000 VA, 99A)
Surge Power for 100 msec	200% (4400VA, 36A)	200% (6000VA, 50A)	200% (4400VA, 36A)	200% (8000VA, 66A)
Power Boost for 5 sec	150% (3300W)	150% (3900W)	150% (3300W)	150% (6000W)
Power Boost for 30 sec	140% (3080W)	140% (3800W)	140% (3080W)	140% (5600W)
Power Boost for 5 min	120% (2640W)	120% (3400W)	120% (2640W)	120% (4800W)
Power Boost for 30 min	110% (2420W)	110% (3200W)	110% (2420W)	110% (4400W)
Maximum Continuous DC Input Current	266 A	373 A	133 A	266 A
Inverter Efficiency (Peak)	90%	90%	93%	94%
No Load Power Consumption in Power Saving Mode	< 8 W			
No Load Power Consumption in Normal Mode (120 VAC Output, Typical)	30 watts		25 watts	
AC INPUT FROM GRID / GENERATOR				
AC Input Voltage	120VAC (60-140VAC +/- 5%)			
AC Input Frequency	60Hz / 50Hz			
Maximum Programmable (Default) AC Input Current	5-40A (Default 30A)	5-70A (Default 30A)	5-40A (Default 30A)	5-70A (Default 30A)
TRANSFER CHARACTERISTICS				
Transfer Relay Type and Capacity	SPDT, 40A	DPDT, 70A (2X35A contacts in parallel)	SPDT, 40A	DPDT, 70A (2X35A contacts in parallel)
Transfer Time – Inverter to Grid / Generator	< 1 ms (Synchronized Transfer at Zero Crossing).			

SECTION 7 | Specifications

Transfer Time – Grid / Generator to Inverter	Up to 16ms (Synchronized Transfer)			
Models	EVO-2212	EVO-3012	EVO-2224	EVO-4024
OPERATING MODES				
OFF-LINE Mode	Grid/Generator Priority (Default) <ul style="list-style-type: none"> Grid/Generator supplies AC loads and charges batteries Inverter is standby 			
ON-LINE Mode	Inverter Priority (Programmable) <ul style="list-style-type: none"> Inverter supplies AC loads even if Grid/Generator is available Grid/Generator takes over when batteries are discharged to "Battery Low Alarm" to charge batteries and to power AC loads. AC loads are transferred back to Inverter at Reconnect Voltage 			
INTERNAL BATTERY CHARGER SECTION				
AC Input Voltage Range	120 VAC (60 to 140 VAC +/-5%)			
Max Continuous AC Input Current	15A, AC	20A, AC	19A, AC	30A, AC
AC Input Power Factor	> 0.95			
Programmable DC Output Charging Current	0-100A, DC	130A, DC	70A, DC	110A, DC
Charger Efficiency	75%		86%	85%
Charging Stages	<ul style="list-style-type: none"> Normal Mode: 3 Stages – Bulk, Absorption and Float Equalization Mode: 4 Stages – Bulk, Absorption, Equalization and Float Adaptive Charging Control 			
Battery Temperature Compensation	<ul style="list-style-type: none"> Battery Temperature Sensor included Compensation Range from -20° C to 60° C 			
EXTERNAL BATTERY CHARGER SECTION (Solar Charge Controller)				
Charging Voltage Range	13-15VDC	13-15VDC	26-30VDC	26-30VDC
Maximum Charging Current	50A			
COOLING, PROTECTIONS AND ALARMS				
Cooling	2 Fans – Temperature Controlled, Variable Speed			
Protections and Alarms	Battery Low Voltage Alarm and Low / Over Voltage Shut Down			
	Shut Down under Input Over Current, Output Over Current, Output Overload and Output Short			
	Transformer and Heat Sink Overheat Shut Down			
	Immunity Against Conducted Electrical Transients in Vehicles			
OPTIONAL REMOTE CONTROL				
Model No.	EVO-RC (see Appendix A)			
Specifications	<ul style="list-style-type: none"> Advanced Features for programming various parameters and modes of operation 2 Rows of 16 Character Alpha Numeric LCD Display for messaging Up to 16 GB SD Card Slot for Data Logging Comes with 10M / 33ft RJ-45 Data Cable 			

SECTION 7 | Specifications

SAFETY AND COMPLIANCE				
Safety Compliance	<ul style="list-style-type: none"> • Intertek-ETL listed: Conforms to ANSI / UL STD. 1741 • Intertek-ETL listed: Certified to CAN / CSA STD. C22.2 No. 107.1-01 • Intertek-ETL listed: Conforms to ANSI / UL STD. 458 with Marine Supplement* 			
EMI / EMC Compliance	<ul style="list-style-type: none"> • Certified to FCC Part 15(B), Class B 			
ENVIRONMENTAL SPECIFICATIONS				
Operating Temperature	-20° C to +60° C (-4° F to 140° F)			
Storage Temperature	-40° C to +70° C (-40° F to 158° F)			
Operating Humidity	0 to 95% RH non condensing			
WEIGHTS AND DIMENSIONS				
Dimensions: W x D x H	325 x 426 x 207 mm; 12.79 x 16.77 x 8.15 in			
Weights:	27 Kg / 59 lb.	29 kg / 64 lb.	26 Kg / 57 lb.	29 Kg / 64 LB

NOTES:

- (1) All AC power ratings in the Inverter Section are specified at Power Factor = 0.95
- (2) All specifications given above are at Ambient Temperature of 25°C unless specified otherwise
- (3) Specifications are subject to change without notice
- (4) * Marine Supplement is valid when installed using Drip Shield. Please see Figs 3.1(a), 3.2(b), 3.3(b) and 3.4(b).

SECTION 8 | Warranty

2 YEAR LIMITED WARRANTY

EVO Series Inverter Chargers manufactured by Samlex America, Inc. (the “Warrantor”) are warranted to be free from defects in workmanship and materials under normal use and service. The warranty period is 2 years for the United States and Canada, and is in effect from the date of purchase by the user (the “Purchaser”).

Warranty outside of the United States and Canada is limited to 6 months. For a warranty claim, the Purchaser should contact the place of purchase to obtain a Return Authorization Number.

The defective part or unit should be returned at the Purchaser’s expense to the authorized location. A written statement describing the nature of the defect, the date of purchase, the place of purchase, and the Purchaser’s name, address and telephone number should also be included.

If upon the Warrantor’s examination, the defect proves to be the result of defective material or workmanship, the equipment will be repaired or replaced at the Warrantor’s option without charge, and returned to the Purchaser at the Warrantor’s expense. (Contiguous US and Canada only) using a carrier of the warrantor’s choice.

Warranty service shall be performed only by the Warrantor. Any attempt to remedy the defect by anyone other than the Warrantor shall render this warranty void. The warranty does not apply to units with a serial number that has been altered, removed or modified in any way.

There is no warranty for defects or damages to equipment or parts caused by:

- Installation, alternation, inspection or removal
- Normal wear and tear
- Abuse or misuse of the equipment including exposure to excessive heat, salt or fresh water spray, or water immersion
- Corrosion, fire, lightening, biological infestations or Acts of God
- Repairs attempted by anyone other than the Warrantor
- Improper use, contrary to operational instructions provided in product manual
- Shipping or transport

No other express warranty is hereby given and there are no warranties which extend beyond those described herein. This warranty is expressly in lieu of any other expressed or implied warranties, including any implied warranty of merchantability, fitness for the ordinary purposes for which such goods are used, or fitness for a particular purpose, or any other obligations on the part of the Warrantor or its employees and representatives.

There shall be no responsibility or liability whatsoever on the part of the Warrantor or its employees and representatives for injury to any persons, or damage to person or persons, or damage to property, or loss of income or profit, or any other consequential or resulting damage which may be claimed to have been incurred through the use or sale of the equipment, including any possible failure of malfunction of the equipment, or part thereof. The Warrantor assumes no liability for incidental or consequential damages of any kind.

Samlex America Inc. (the “Warrantor”)
www.samlexamerica.com

Contact Information

Toll Free Numbers

Ph: 800 561 5885

Fax: 888 814 5210

Local Numbers

Ph: 604 525 3836

Fax: 604 525 5221

Website

www.samlexamerica.com

USA Shipping Warehouse

Kent WA

Canadian Shipping Warehouse

Delta BC

Email purchase orders to

orders@samlexamerica.com



samlexamerica®

APPENDIX A



samlexpower®

**Remote Control
for Evolution
Series Inverter
Charger**

Model: EVO-RC

**Owner's
Manual**

Please read this
manual **BEFORE**
operating.

NOTE: REMOTE CONTROL MODEL NO. EVO-RC IS OPTIONAL AND IS REQUIRED TO BE ORDERED SEPARATELY.

SECTION 1

Safety Instructions, Introduction and Layout 3

SECTION 2

Installation 4

SECTION 3

Operation 6

SECTION 4

Parameter Setup 11

SECTION 5

SD Card 30

SECTION 6

Monitoring of Operation Using LED and Buzzer 35

SECTION 7

Fault Messages and Troubleshooting Guide 36

SECTION 8

Specifications 39

SECTION 9

Warranty 40

1.0 INTRODUCTION AND LAYOUT

The EVO-RC Remote Control allows you to monitor and customize the operating parameters of Samlex EVO Inverter Charger Models EVO-2212, 2224, 3012 and 4024. Layout is shown in Fig. 1.1(a) and (b) below.

1. LCD Screen – 2 rows of 16 characters each
2. ON/OFF Key
3. Green LED "Status"
4. Red LED "Alarm" (Fault)
5. Navigation Key "Back"
6. Navigation Key "Up"
7. Navigation Key "Down"
8. Navigation Key "Enter"
9. SD Card Slot – FAT16/32 format; Up to 16 GB
10. RJ-45 Jack (At the back-not shown)
11. RJ-45 Data Cable (Straight Wired), 10 meter/33 feet length {Fig.1.1(b)}

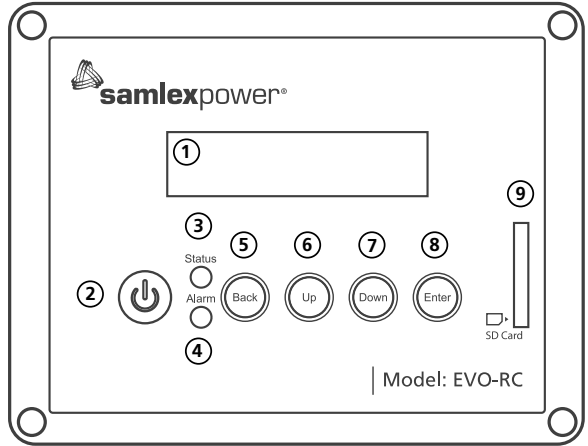

Fig. 1.1(a) Optional Remote Control EVO-RC – Layout



Fig. 1.1(b) Cable For Remote Control EVO-RC

2.1 INSTALLATION GUIDELINES

The remote control is provided with 10M/33ft, RJ-45 Data Cable (Straight Wired). Check the proposed routing distance of the wire and use longer wire, if necessary.

- Flush mounting of the Remote requires appropriate cut-out in the wall/panel. Take necessary precautions to ensure any wiring/plumbing running behind the wall/panel is not damaged.
- Route the wire to ensure there are no kinks.
- Use appropriate grommets when the wire is passed through holes in studs/partitions to prevent damage to insulation.

2.1.2 Tools Required

Following tools are recommended:

- Phillips Head Screwdriver
- Level
- Hand Drill
- Knife/Saw
- Pencil
- Drill Bit (2.5mm / #39)

Panel Cutout

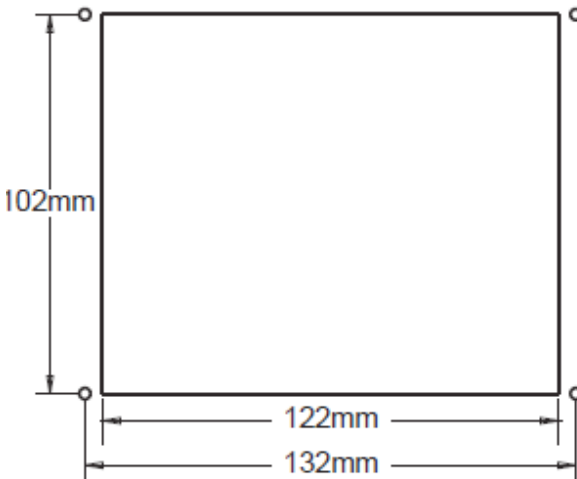

Fig 2.1 EVO-RC Remote Cutout Dimensions

2.2 FLUSH MOUNT INSTALLATION

To flush mount, the wall opening must have at least a 2" (5 cm) depth to make room for the remote and cable. Also, the thickness of wall/panel board at the place of mounting should not be more than 13 mm to ensure that the RJ-45 jack opening is not obstructed (see Fig. 2.3).

1. Cut an opening in the wall using the supplied paper template (based on Fig 2.1).
2. Drill four pilot holes (use 2.5mm diameter/#39 drill bit) for the 4 screws (3mm diameter, 16mm long) that will attach the remote to wall (refer to Figure 2.1 for hole locations and dimensions).
3. Route one end of the cable through wall opening to the EVO Inverter Charger, and then plug it into the RJ45 Remote Control Jack port on the EVO Inverter Charger.

4. Take the other end of remote cable and plug it into the RJ-45 Jack at the back of the EVO-RC (Fig. 2.3).
5. Check the remote display to ensure the Power-up self test initiates.
6. If the self test is successful, secure the EVO-RC to the wall using the four screws. (Fig 2.2)

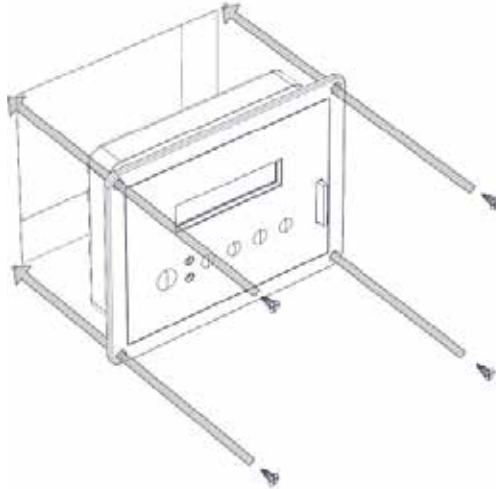

Flush mounting the EVO-RC on the wall with 4pcs, $\Phi 3\text{mm}$ self-tapping screws (flat head).

Fig 2.2 EVO-RC Flush Mounting

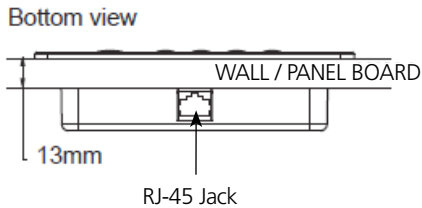

The thickness of the wall/panel board at the place of mounting should not be more than 13mm to ensure that the RJ-45 jack opening is not obstructed.

Fig 2.3 Wall/Panel Thickness

3.0 GENERAL INFORMATION

EVO-RC Remote Control provides the user with the ability to modify EVO Inverter Charger's operating parameters. The default settings in EVO Inverter Charger are adequate for some installations but may have to be modified for others. This Section provides details on the remote functions, status and menu maps and displays, fault messages and parameter settings.

3.1 NAVIGATING THE REMOTE

The EVO-RC provides menu items and adjustable settings to configure your EVO Inverter Charger to your specific parameters. Please refer to the layout at Fig 1.1(a).

- **LCD Display (1)** – The 2-line (16 characters each) LCD display shows status and information for the EVO Inverter Charger. All Setup Menus and faults also appear on the LCD display.
- **ON/OFF Key (2)** – The ON/OFF Key is used for switching ON/switching OFF the EVO Inverter Charger.
- **Navigation Keys (5, 6, 7, 8)** – These four Keys allow simple access to menu items that assists configuring, monitoring, and troubleshooting the EVO Inverter Charger.
 - **Navigation Key Functions:**
 - **Back** – Return to previous selection
 - **Up** – Move to upper Group Number or upper Page Number Screen in various Menu Maps.
 - **Down** – Move to lower Group No. or lower Page No. Screen in various Menu Maps.
 - **Enter** – Enter the selected option
- **Status** – Green LED indicator for indicating operating status (see details at Section 6, Table 6.1)
- **Alarm (Fault)** – Red LED indicator for indicating fault conditions (see details at Section 6, Table 6.1)
- **SD Card socket** – This slot supports SD memory card (up to 16GB; FAT 16/32). The SD Card is used for (i) data logging of EVO Inverter Charger's operational statistics and events and (ii) saving and uploading of programmed parameters. See Section 5: SD Card.

3.2 POWER ON / POWER OFF

Power ON

Press **ON/OFF** Key and hold for 2 seconds to turn the EVO Inverter Charger ON.

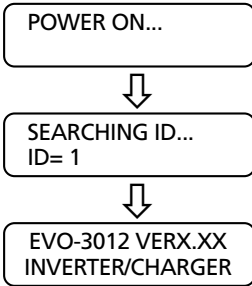

When the EVO Inverter Charger is OFF and the **ON/OFF** key is pressed and held, the LCD screen shows "POWER ON..." and the Status LED flashes 3 times. After 2 seconds, EVO-RC starts to search for the communication ID of the EVO Inverter Charger it is attached to. The LCD screen shows "SEARCHING ID" on the first line and shows the ID number found on the second line. When the default ID of "1" is found, the display will then show the EVO Inverter Charger Model No. and Firmware Version (3 digit number X.XX) as shown on the left.

Power OFF

Press **ON/OFF** Key and hold for 5 seconds to turn OFF the EVO Inverter Charger.

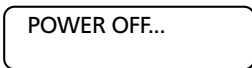

When EVO Inverter Charger is ON and the **ON/OFF** key is pressed and held for minimum of 5 seconds, the LCD screen will show "POWER OFF..." and both the Status and Alarm LEDs will turn ON. Now release the ON/OFF key (Please note that Power Off sequence will be completed and display "POWER OFF..." will disappear only when the ON/OFF key is released).

NOTE: If the EVO Inverter Charger has AC input voltage over 60VAC, the Power OFF function is disabled and the unit will remain in the ON condition if the power off sequence is attempted. The AC input must be removed before the unit can be powered OFF.

3.3 DATE AND TIME SETUP

Set date and time as per procedure given at Section 4.9: "GROUP 6 PARAMETER SETUP: TIME SETTING".

3.4 STANDBY MODE

When in Standby Mode, the EVO will stop inverting or passing through AC input to AC output. Also, charging is cancelled when in Standby Mode.

A short press (0.1 seconds) of the **ON/OFF** Button will change the operational mode from Inverting or Charging Mode to Standby Mode. A subsequent short press when in Standby Mode will return the EVO Inverter Charger to Inverting or Charging Mode.

This mode is used for uploading firmware for EVO Inverter Charger through the SD Card.

This mode may also be used to temporarily halt inverting, charging and AC pass through.

3.5. FAULT CLEARING

If any fault occurs, the LCD screen will display the Fault Message, Red LED Alarm (Fault) will be lighted. Remove cause of the fault and the unit will remain in Fault Mode. A short press (0.1 seconds) of the **ON/OFF** button will clear the Fault Message and the EVO Inverter Charger will return to operational status (if the fault condition no longer exists). Refer to section 7 on "Fault Messages".

3.6 OPERATING MODES AND DISPLAY SCREENS

There are 4 Operating Modes for the EVO Inverter Charger that will be displayed on the Remote Screen at any given time (see Fig 3.1): (i) Standby (ii) Inverting (iii) Charging and (iv) Power Saving. Each mode has several screens of status information such as Voltage/Current/Power etc. The majority of Mode screens shown in Fig 3.1 are self explanatory, but the Charging Mode Status screens require additional details which are shown at Section 3.6.1.

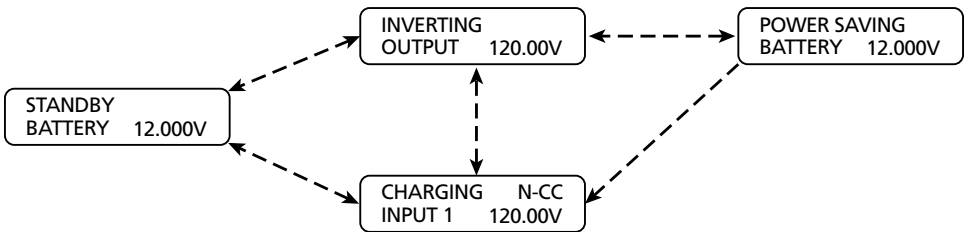

Fig 3.1 EVO-RC Mode Screens

3.6.1 Charging Mode Screens Explanations

Please refer to 18 Screens shown against Pages 1 to 18 under Group 3 "CHARGING" at Fig 3.2. The 1st line of the Display Screen for Charging Mode shows CHARGING on the left and abbreviated information format "Charging Mode - Charging Stage" on the right corner. The following abbreviations have been used:

Abbreviation (Group 3 Screens)	Normal (N), 3 Stage Charging: Bulk, Absorption, Float	Equalization (E), 4-Stage Charging: Bulk, Absorption, Equalization, Float
N-CC	Constant Current (CC), Bulk Stage	–
N-CV	Constant Voltage (CV), Absorption Stage	–
E-CC	–	Constant Current (CC), Bulk Stage
E-CVA	–	Constant Voltage Absorption (CVA) Stage
E-CVE	–	Constant Voltage Equalization (CVE) Stage
FLOAT	Float Stage	Float Stage

For example, in Fig 3.2, the 1st line of information under Column 4 (Group 3) "Charging" shows "N-CC" in the right corner. This means that the unit is in Normal (N), 3-Stage Charging Mode and is in Constant Current (CC) Bulk Stage.

3.6.2 Overall Operating Mode Display Screen Menu Map

Overall Operating Mode Display Screen Menu Map is shown at Fig 3.2. Any screen within the Menu Map can be identified by 2 co-ordinates: "Group No." (Column) and "Page No." (Row).

↓ Page Up (Up key) *

↑ Page Down (Down key) **

Fault Message

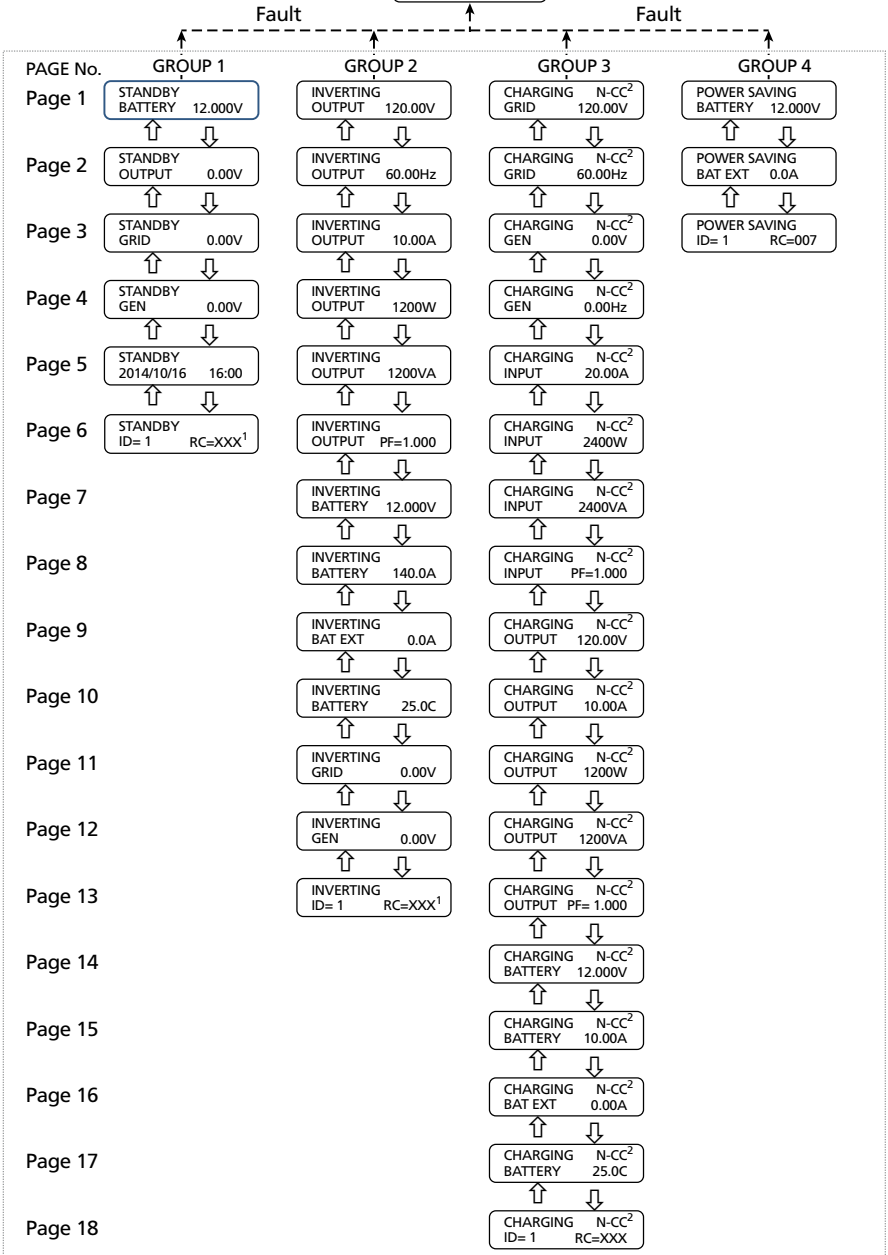

NOTES: Please see next Page 10.

Fig 3.2 Overall Operating Mode Display Screen Menu Map

NOTES FOR FIG 3.2:

1. The 3-digit numbers XXX in “RC-XXX” indicate the Revision No. of the firmware for the Remote Control EVO-RC
2. The 3 or 4-digit abbreviations on the top right corner of the 18 Screens (Pages 1 to 18) for “CHARGING” Mode (Column 4, Group 3) will indicate one of the following 6 charging states:

Abbreviation	Normal (N) 3 Stage Charging	Equalization (E) 4-Stage Charging
N-CC	Constant Current (CC), Bulk Stage	–
N-CV	Constant Voltage (CV), Absorption Stage	–
E-CC	–	Constant Current (CC), Bulk Stage
E-CVA	–	Constant Voltage Absorption (CVA) Stage
E-CVE	–	Constant Voltage Equalization (CVE) Stage
FLOAT	Float Stage	Float Stage

18 Screens (Pages 1 to 18) for “CHARGING” Mode (Column 4, Group 3) are shown as an example for Bulk Charging Stage in Normal Charging Mode (N-CC). Depending upon the Charging Mode and Stage the unit is in at any particular time, 18 sets of screens will be seen for each of the 6 states of operation in Charging Mode: N-CC, N-CV, E-CC, E-CVA, E-CVE or Float

- * Page Up is shown with downward pointer ↓ because Page Nos. in this Menu Map increase in the downward direction
- ** Page Down is shown with upward pointer ↑ because Page Nos. in this Parameter Setting Menu Map decrease in the upward direction

4.0 GROUP AND PARAMETER SETUP MENUS

Up to 46 operating parameters can be programmed to suit the desired operating conditions.

The operating parameters have been organized in 7 "Select Group" Menus (Groups 1 to 7) as shown in Parameter Setup Menu Maps at Fig 4.1 for Groups 1 to 4 and Fig 4.2 for Groups 5 to 7. For convenience, each Parameter Setup Screen in Figs 4.1 and 4.2 can be referenced by 2 co-ordinates: Group No. (Column) and Page No. (Row).

The desired Parameter Setup Screen can be reached by navigating through the "Select Group" Menus as shown in the Select Group Menu Map at Fig 4.3.



INFO

In this section, parameter set up procedures have been explained using LCD screen displays with information as seen on the actual LDC screens. All parameters shown on the second row of the screen displays are the default parameters. All voltage values related to battery voltages are the default values for 12V versions EVO-2212/3012. (Double these values for the 24V versions EVO-2224/4024)

4.1 PARAMETER SETUP MENU MAPS

- ↓ Page Up (Up Key)*
- ↑ Page Down (Down Key)**
- ⇒ Enter Key (To Group towards the right)
- ⇐ Back Key (To Group towards the left)

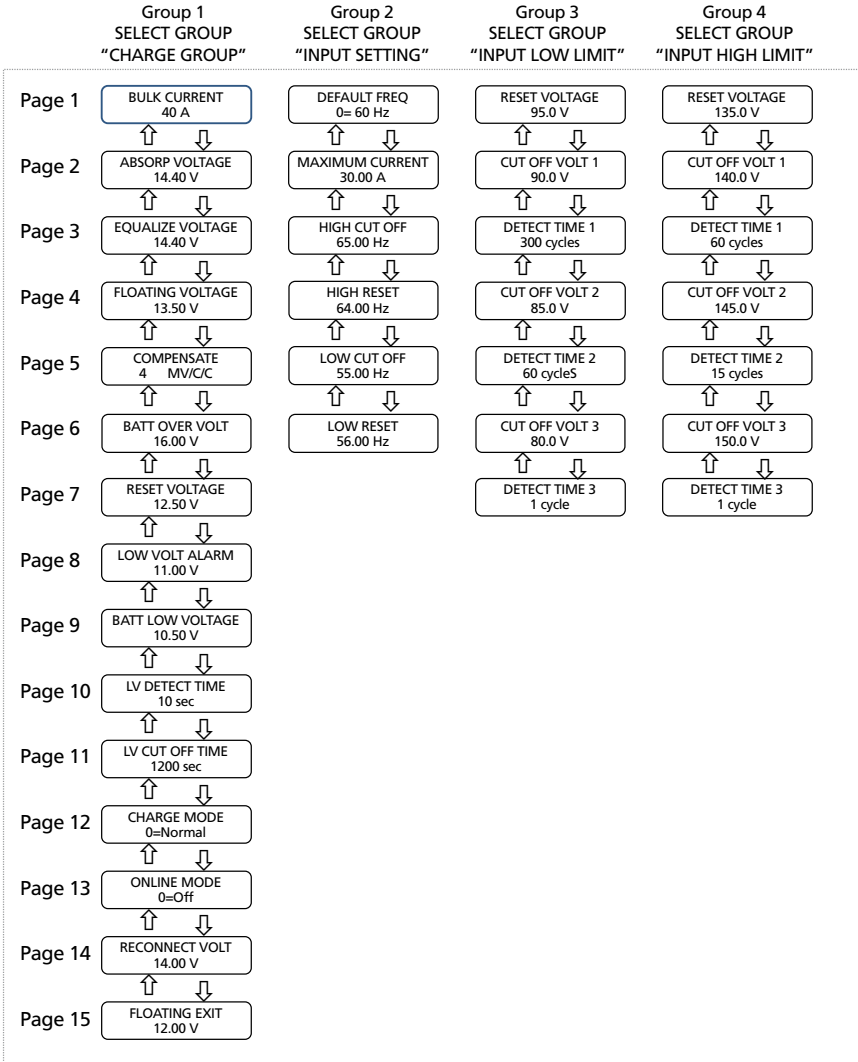

NOTES: Please refer to Page 13.

Fig 4.1 Parameter Setup Menu Map – Groups 1 to 4

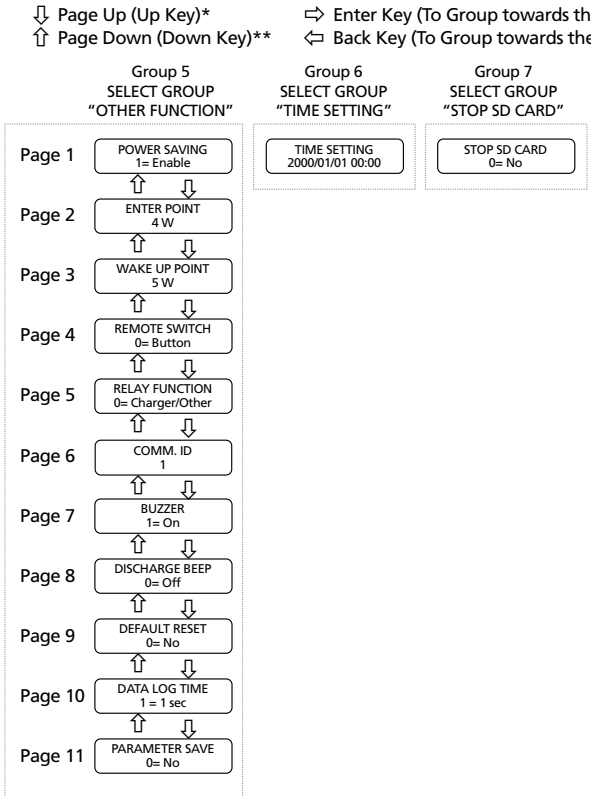

Fig 4.2 Parameter Setup Menu Map – Groups 5 to 7

NOTES FOR FIG 4.1 AND 4.2:

- Values or parameters shown are the default values. Voltage values under Group 1 are for 12V versions EVO-2212/3012. Double these values for 24V versions EVO-2224/4024.
- For details of programmable ranges and default values of each of the parameters, please refer to Tables and Sections given below.

Group No. of Parameter Select	Table No.	Section No.
Group 1	4.4	4.4
Group 2	4.5	4.5
Group 3	4.6	4.6
Group 4	4.7	4.7
Group 5	4.8	4.8
Group 6	-	4.9
Group 7	-	4.10

* Page Up is shown with downward pointer ↓ because Page Nos. in this Parameter Setting Menu Map increase in the downward direction

** Page Down is shown with upward pointer ↑ because Page Nos. in this Parameter Setting Menu Map decrease in the upward direction

4.2 PARAMETER SETUP PROCEDURE – GENERAL

Please refer to Fig 4.3 below.

The **Enter** key is used to enter Parameter Setup Mode from any Operating Mode Screen in Fig 3.2. Example in Fig 4.3 below starts with Inverting Mode Screen (Group 2, Page 1 in Fig 3.2). After the **Enter** key is pressed, the **Up/Down** keys are used to navigate to the different Parameter Groups (Groups 1 to 7). When the Group for the desired setting is displayed on the LCD, the **Enter** Key is used again to select this Group. The **Up** and **Down** Keys are used to move to the individual parameters within the Group.

Pressing the **Back** Key will exit the specific Parameter, or Group backing to previous level.

There is a 30 second timeout for setting parameters; after 30 seconds the Setting Mode will be cancelled and the EVO-RC will revert to the mode associated with current operation.

It is highly recommended to set the EVO Date and Time (Parameter Group 6) as this value is used to record data logging files. (Refer to Section 4.9 for Date and Time set up).

- ⇒ Enter Key ↓ Group up (Up Key)*
- ⇐ Back Key ↑ Group down (Down Key)**

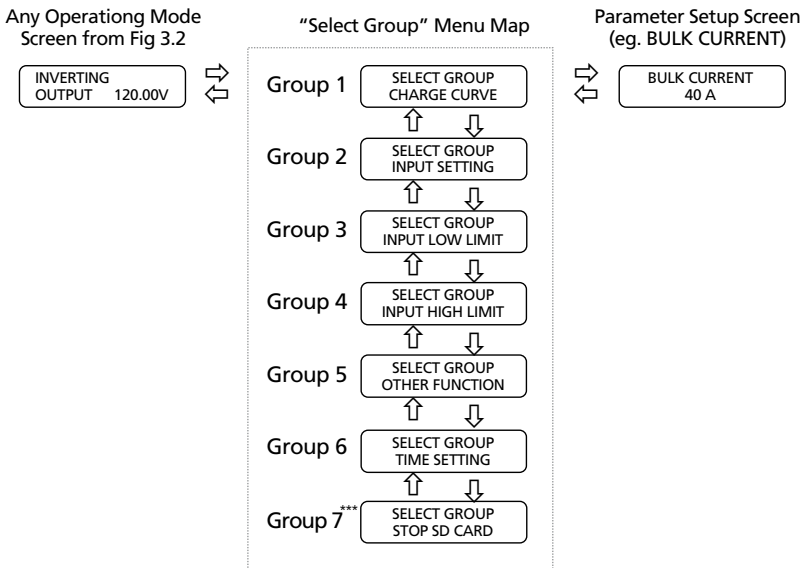

Fig 4.3 "Select Group" Menu Map and Example for Setting Bulk Current

NOTES:

- * Group Up is shown with downward pointer ↓ because Group Nos. in this Menu Map increase in the downward direction
- ** Group Down is shown with upward pointer ↑ because Group Nos. in this Menu Map decrease in the upward direction
- *** Group 7 screen will be shown only when SD card is inserted.

4.3 PASSWORD PROTECTION FOR PARAMETER CHANGE

All parameters except Time and Date are protected with a Password. When the required parameter screen is reached and is displayed and **Enter** Key is pressed to modify the parameter value, the system will request a 4-digit Password. **The Password is 8052.** Once you **Enter** the Password correctly, you don't need to enter the Password again until until any key is not pressed for over 60 seconds. An example of Parameter setting is shown at Section 4.3.1 below:

4.3.1 Example of Changing Bulk Current Setting – From Default 40A to 50A

SELECT GROUP
CHARGE CURVE

Starting from any Operating Mode Screen (Fig 3.2), press **Enter** key and **Up/Down** Keys to select Group 1 "Charge Curve" screen from the "Select Group" Menu Map (Fig 4.3).

Press **Enter** Key to go to Parameter Screens under "Charge Curve".

BULK CURRENT
40 A

Press **Up/Down** Key to select Bulk Current parameter. Default current setting of 40A will be displayed.

Press Enter key to change Bulk Current parameter setting. A Password will be requested.

KEY IN PASSWORD
0000

Press Up/Down key to change each number. When displayed value is correct, a **short** press of the **Enter** Key will confirm this value and move to the next digit to the right. A **long** press of the Enter Key is used to write the parameter selection (the Password in this case).

PASSWORD CORRECT

Flashes twice when Password is correct. (8052)

PASSWORD ERROR!!

Flashes twice when Password is not correct.

BULK CURRENT
40 A

Press **Up/Down** Key to change number to 50.

Short press **Enter** Key to shift right, **long** press **Enter** key to set.

BULK CURRENT
!
90 A

An exclamation sign '!' is shown when the parameter is out of the specified programming range. For example, if 90A was entered for EVO-2224 (EVO-2224 range is 0-70A), it will be out of range and an exclamation sign '!' will be displayed.

WRITING...
50 A

Writing to the inverter.

WRITE SUCCESS!
50 A

Flashes twice when writing is successful.

WRITE FAILURE!
50 A

Flashes twice when there is a write failure.

OUT OF RANGE!
90 A

Flashes twice when the set value is out of range. (90 A is out of range for EVO-2224).

BULK CURRENT
50 A

End setting.

Press **Back** Key to go back to Group select or **Up/Down** key to the next parameter.

All programmable parameters (Groups 1 to 7 in Parameter Menu Maps at Figs 4.1 and 4.2) and their Default Values are described below:

4.4 GROUP 1 PARAMETER SET UP: CHARGE CURVE

Please refer to Parameters under Group 1 at Fig 4.1. Details of Parameter set up are given below:

TABLE 4.4. GROUP 1 PARAMETER SET UP: CHARGE CURVE

Page No. for Group 1 (Fig 4.1)	Parameter	Programming Range				Default			
		EVO-2212	EVO-3012	EVO-2224	EVO-4024	EVO-2212	EVO-3012	EVO-2224	EVO-4024
1	"BULK CURRENT" (Bulk Charge Current "I _o ")	0–100A	0–130A	0–70A	0–110A	40A			
2	"ABSORP VOLTAGE" (Absorption Voltage)	13.5V – 16.0V		27.0V – 32.0V		14.4V		28.8V	
3	"EQUALIZE VOLTAGE" (Equalization Voltage)	14.0V – 16.0V		28.0V – 32.0V		14.4V		28.8V	
4	"FLOATING VOLTAGE" (Float Voltage)	13.0V – 15.0V		26.0V – 30.0V		13.5V		27.0V	
5	"COMPENSATE" (Temperature Compensation)	-3mV to -5mV /°C/Cell				-4mV /°C/Cell			
6	"BATT OVER VOLT" (Battery Over Voltage Shut Down)	14.0V – 17.0V		28.0V – 35.0V		16.0V		32.0V	
7	"RESET VOLTAGE" (Battery Low Voltage Reset)	12.0V – 17.0V		24.0V – 35.0V		12.5V		25.0V	
8	"LOW VOLT ALARM" (Battery Low Voltage Alarm)	9.5V – 12.5V		19.0V – 25.0V		11.0V		22.0V	

9	"BATT LOW VOLTAGE" (Battery Low Voltage Shut Down)	>9.0V – 12.0V	>18.0V – 24.0V	10.5V	21.0V
10	"LV DETECT TIME" (Detect Time to Qualify as Battery Low Voltage Shut Down Condition)	0-600 sec		10 sec	
11	"LV CUT OFF TIME" (Time in Low Voltage Shut Down Condition before Shut Down is Activated)	0-7200 sec		1200 sec	
12	"CHARGE MODE" (3 or 4 Stage Charging)	Normal (3-Stage) / Equalization (4-Stage)		0 = Normal (3-Stage)	
13	"ON-LINE MODE" or "OFF-LINE"	0 = OFF (Off-Line: Grid/Generator Priority) 1 = ON (On-Line Mode: Battery/Inverter Priority)			
14	"RECONNECT VOLT" (For On-Line Mode)	13.50V – 16.00V	27.00V – 32.00V	14.00V	27.60V
15	"FLOATING EXIT"	10.00V – 13.00V	20.00V – 26.00V	12.00V	24.00V

BULK CURRENT:

This sets the maximum charging current of EVO Inverter Charger. This value is the sum of charging currents from the internal AC Charger and external Charge Controller connected to the EXT. Charger terminals of EVO Inverter Charger (3,4 Fig 2.1 in Owner's Manual for EVO Inverter Charger).



ABSORP VOLTAGE:

This sets the charging voltage in the Constant Voltage Absorption Stage.

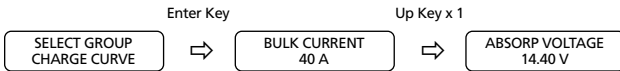

EQUALIZE VOLTAGE:

This sets the charging voltage in the Constant Voltage Stage in the 4-stage Equalization Charging Stage.



FLOATING VOLTAGE:

This sets the charging voltage in the Constant Voltage Float Stage.



COMPENSATE:

This parameter sets the temperature compensation for the battery. The operational range of the EVO Inverter Charger is -20°C to 60°C.

This compensation voltage will affect the Absorb Voltage/Equalize Voltage/Floating Voltage/Batt Over Volt/Restart Voltage/Low Volt Alarm/Batt Low Voltage when the Temperature Sensor is installed on the battery (see Fig 2.5 in the Owner's Manual for EVO Inverter Charger).

**BATT OVER VOLT:**

This parameter sets the upper battery voltage threshold at which inverting / charging operations are switched OFF to protect the unit against damage due to battery overvoltage:

- AC input is not available and EVO Inverter Charger is operating in Inverting Mode:**
 When the battery voltage rises to the set upper threshold of "BATT OVER VOLT", the Inverter Section will be shut down and message "Battery over voltage!" will be displayed on the LCD screen. The Green LED marked "Status" will switch OFF and the Red LED marked "Alarm" will remain ON steady. The buzzer on EVO Inverter Charger will beep steady. The fault will be cleared automatically when the battery voltage drops to 0.5V below the set upper threshold of "BATT OVER VOLT"
- AC input is available and EVO Inverter Charger is operating in Charging Mode:**
 When the battery voltage rises to the set upper threshold of "BATT OVER VOLT", the Transfer Relay will be de-energized, charging and pass through will be stopped and PWM drive to the Inverter Section will be switched OFF. Message "Battery over voltage!" will be displayed on the LCD screen. The Green LED marked "Status" will switch OFF and the Red LED marked "Alarm" will remain ON steady. The Buzzer on EVO Inverter Charger will beep steady. The fault will be cleared automatically when the battery voltage drops to 0.5V below to the set upper threshold of "BATT OVER VOLT". The unit will start in Inverting Mode, synchronize with the AC input and then, the Transfer Relay will be energized to transfer to AC input at zero crossing. The unit will, thus, resume operation in "Charging Mode".

**RESET VOLTAGE:**

The inverter will restart when the battery voltage rises above this set value after Battery Low Voltage shutdown occurs. If Relay Function is set for Generator, the relay will turn OFF.



LOW VOLT ALARM:

When inverting, if battery voltage is under the set value, the Red LED marked "Alarm" flashes once per second. The buzzer in EVO Inverter Charger will beep once per second. If Relay Function is set for Generator, the relay will turn ON. If in On-Line Mode, it will transfer from Inverting Mode to Charging Mode.

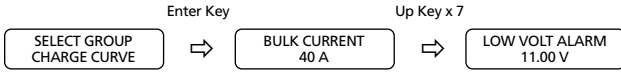

BATT LOW VOTLAGE:

This parameter sets the battery low voltage threshold at which the Inverter Section / the complete EVO Inverter Charger will be shut down to protect the battery from deep discharge:

- When the battery voltage drops to the set threshold of "BATTERY LOW VOLTAGE", the Red LED marked "Alarm" will flash once per second. The buzzer in EVO Inverter Charger will beep once per second. The Inverter Section will continue to operate normally and the Green LED marked "Status" will continue to be ON steady.
- If the battery voltage stays at or below the above threshold for duration equal to the "LV DETECT TIME" described below, only the Inverter Section will be switched OFF and message "Battery low voltage!" will be displayed. The Green LED marked "Status" will be switched OFF and the Red LED marked "Alarm" will remain ON steady. The buzzer in EVO Inverter Charger will beep steady.
- If the "Battery low voltage!" fault condition is not reset within the "LV CUTOFF TIME", the EVO Inverter Charger will be shut down completely after "LV CUTOFF TIME" has elapsed.
- If the batteries are charged by external charger connected directly to the batteries or through the External Charger Input (3, 4 in Fig 2.1 in EVO Inverter Charger Manual) and the battery voltage recovers to the set "RESTART VOLTAGE" before the expiry of "LV CUT OFF TIME" while in "Battery low voltage!" fault condition, the Inverter Section will restart and the "Battery low voltage!" fault condition will be cleared.
- While in "Battery low voltage!" fault condition, if AC input is made available before the expiry of "LV CUT OFF TIME", the "Battery low voltage!" fault condition will be cleared. The EVO Inverter Charger will restart in Inverter Mode, synchronize with the AC input and then, transfer to the AC input at zero crossing. It will now operate in Charging Mode.



LV DETECT TIME:

To prevent low battery shut down of the inverter due to momentary dips in battery voltage as a result of high power, short duration AC loading (e.g. motor starting, inrush current etc.), a timer is used to qualify battery low condition only if the battery voltage drops to or below the set "BATTERY LOW VOLTAGE" threshold for the set "LV DETECT TIME". The timer starts as soon as the battery voltage drops to the set threshold of "BATTERY LOW VOLTAGE" described above.

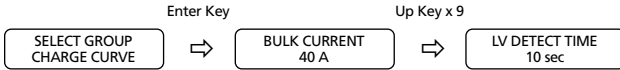

LV CUT OFF TIME:

Even when the Inverter Section is shut down due to “Battery low voltage!” fault condition as described above, there will still be some power drawn from the battery to keep the other circuitry in the EVO Inverter Charger alive so that the inverter can be switched on when the fault gets cleared automatically after the battery has been recharged to the “RESET VOLT-AGE” or when AC input voltage is available. However, if the fault is not cleared over a long period of time, the battery may get completely discharged. Hence, a timer is used to record the duration of “Battery low voltage!” condition. The EVO Inverter Charger will be completely shut down when the duration of the “Battery low voltage!” fault condition as described above is equal to the “LV CUT OFF TIME”.

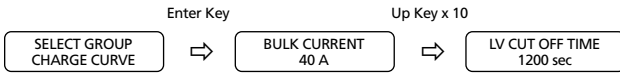

CHARGE MODE:

Default setting is 3-Stage “Normal Mode” (Parameter Screen setting shows “0=Normal”). The mode can be changed at any time to 4-stage “Equalization Mode” (Change Screen setting to “1=Equalize”). After “Equalization Mode” is completed (the charger enters Float Stage after completing Equalization Stage), the screen automatically resets to Normal (0=Normal).



ON-LINE MODE

In this mode, PRIORITY is given to the Inverter Section. Even if qualified AC input (within the programmed voltage and frequency limits) is available at the Grid / Generator AC inputs, the unit always operates in “Inverting Mode” and AC output is provided by the Inverter Section as long as the battery is in charged condition above the “LOW VOLT ALARM” threshold. When the battery discharges to the programmed value of “LOW VOLT ALARM” threshold [12V Version: 9.50V to 12.50V (Default 11.0V); 24V Version: 19.00V to 25.00V (Default 22.00V)], Transfer Relay energizes and the unit changes over to “Charging Mode” and qualified AC input from the Grid / Generator is passed through to the AC Output and at the same time, the Internal AC Charger starts charging the battery. If an external charger is also connected to the External Charging Terminals, the internal AC Charger will limit the charging current to a value = (Programmed Value of Charging Current – Value of Current fed from the External Charger). When the battery voltage rises to the programmed value of “RECONNECT VOLTAGE” [12V Version: 13.50V to 16.00V (Default 14.0V); 24V Version: 27.00V to 32.00V (Default 27.6V)], the Transfer Relay is de-energized, the unit changes over to “Inverting Mode” and the AC Output is fed from the internal Inverter Section.

In the Default Mode (also called Off-Line Mode), PRIORITY is given to the AC input fed from the Grid / Generator Inputs. If qualified AC input (within the programmed voltage and frequency limits) is available at the Grid / Generator AC inputs, Transfer Relay energizes and the unit operates in “Charging Mode” and qualified AC input from the Grid / Generator is passed through

to the AC Output and at the same time, the Internal AC Charger starts charging the battery. If an external charger is also connected to the External Charging Terminals, the internal AC Charger will limit the charging current to a value = (Programmed Value of Charging Current – Value of Current fed from the External Charger). When the Grid / Generator AC input fails or is not within the programmed value of voltage and frequency, the Transfer Relay is de-energized, the unit changes over to “Inverting Mode” and the AC Output is fed from the internal Inverter Section. When Grid / Generator input is restored, the unit reverts back to “Charging Mode”.

On-line Mode is programmed through the Remote Control EVO-RC by setting ONLINE MODE [1=ON] as shown in the steps given below. The Default Setting is Off-Line Mode [0=OFF].



RECONNECT VOLT:

As explained under "ON-LINE MODE" above, "RECONNECT VOLT" setting is the battery voltage at which the unit transfers from "Charging Mode" to "Inverting Mode".



FLOATING EXIT:

Please refer to Sections 5.6.4 and 5.8 of the EVO Owner’s Manual regarding automatic resetting of 3 and 4 Stage Charging Cycles respectively. When charging is in Float Stage and the battery discharges to the programmed discharged voltage level, the Charging Cycle is reset to the Bulk Stage of the 3 Stage Charging Profile. The programmable range of this voltage level is 10 to 13V for 12V battery and 20 to 26V for 24V battery and the Default Setting is 12V for 12V battery and 24V for 24V battery.



4.5 GROUP 2 PARAMETER SET UP: INPUT SETTING

Please refer to Parameters under Group 2 at Fig 4.1. Details of Parameter set up are given below:

TABLE 4.5. GROUP 2 PARAMETER SET UP: INPUT SETTING									
Page No. for Group 2 (Fig 4.1)	Parameter	Setting range				Default value			
		2212	3012	2224	4024	2212	3012	2224	4024
1	DEFAULT FREQ	50 / 60Hz				60Hz			
2	MAXIMUM CURRENT	5 – 40A	5 – 70A	5 – 40A	5 – 70A	30A			
3	HIGH CUT OFF	50 – 70Hz				65Hz			
4	HIGH RESET	50 – 70Hz				64Hz			
5	LOW CUT OFF	40 – 60Hz				55Hz			
6	LOW RESET	40 – 60Hz				56Hz			

DEFAULT FREQ:

Default frequency sets the Inverter frequency, which is also the standard frequency for AC input.



MAXIMUM CURRENT:

In Charging Mode, the net AC input current from the Grid/Generator is the sum of the AC side charging current and the pass through load current. Based on the rated capacity of the Grid Branch Circuit/Generator, the net AC input current will be required to be limited to prevent overloading of the Grid Branch Circuit/Generator.

EVO Series has a very powerful battery charger that will require a proportionate higher AC input current from the Grid/Generator. The Grid/Branch Circuit/Generator will also be required to provide current to the AC loads. The desired maximum value of input current from Grid/Generator can be programmed (Default is 30A). The EVO will automatically reduce charging current to support the AC loads on priority and use whatever is extra for charging. This will prevent overloading of the Grid Branch Circuit/Generator. If the AC input current is over the setting value by 1A for 5 seconds, the EVO Inverter Charger will stop outputting and display an error message "Input over current" on LCD screen.



HIGH CUT OFF:

If the AC input frequency is over the value of "HIGH CUT OFF" when in "Charging Mode", the EVO Inverter Charger will transfer to Inverting Mode.



HIGH RESET:

This is the reset frequency at which the unit will revert to "Charging Mode" after it has switched over to "Inverter Mode" due to input frequency rising above "HIGH CUT OFF".



LOW CUT OFF:

If the AC input frequency is below "LOW CUT OFF" value when in "Charging Mode", the EVO Inverter Charger will transfer to Inverting Mode.



LOW RESET:

This is the reset frequency at which the unit will revert to "Charging Mode" after it has switched over to "Inverting Mode" due to input frequency falling below "LOW CUT OFF".

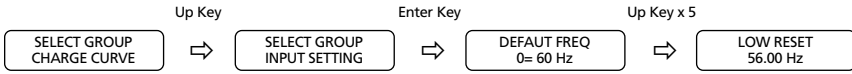

4.6 GROUP 3 PARAMETER SET UP: INPUT LOW LIMIT

Please refer to Parameters under Group 3 at Fig 4.1. Details of Parameter set up are given below:

TABLE 4.6. GROUP 3 PARAMETER SET UP: INPUT LOW LIMIT									
Page No. for Group 3 (Fig 4.1)	Parameter	Setting range				Default value			
		2212	3012	2224	4024	2212	3012	2224	4024
1	RESET VOLTAGE	60.0 – 200.0V				95.0V			
2	CUT OFF VOLT 1	60.0 – 200.0V				90.0V			
3	DETECT TIME 1	0 – 2000 cycles				300 cycles			
4	CUT OFF VOLT 2	60.0 – 200.0V				85.0V			
5	DETECT TIME 2	0 – 2000 cycles				60 cycles			
6	CUT OFF VOLT 3	60.0 – 200.0V				80.0V			
7	DETECT TIME 3	0 – 2000 cycles				1 cycle			

RESET VOLTAGE:

This is the reset voltage at which the unit will revert to "Charging Mode" after it has switched over to "Inverting Mode" due to input voltage falling to "CUT-OFF VOLT 1/CUT-OFF VOLT 2/CUT-OFF VOLT3".



CUT OFF VOLT 1:

If during "Charging Mode", the AC input voltage falls below "CUT-OFF VOLT 1" for period > "DETECT TIME 1", the EVO Inverter Charger will transfer to Inverting Mode from "Charging Mode".



DETECT TIME 1:

This is the time limit in cycles up to which low AC input voltage "CUT-OFF VOLT 1" is allowed.



CUT OFF VOLT 2:

If during "Charging Mode", the AC input voltage falls below "CUT-OFF VOLT 2" for period > "DETECT TIME 2", the EVO Inverter Charger will transfer to "Inverting Mode".



DETECT TIME 2:

This is the time limit in cycles up to which low AC input voltage "CUT-OFF 2" is allowed.

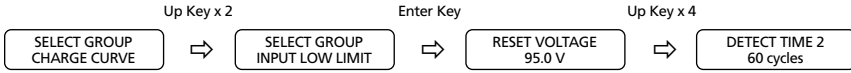

CUT OFF VOLT 3:

If during "Charging Mode", the AC input voltage falls below "CUT-OFF VOLT 3" for period > "DETECT TIME 3", the EVO Inverter Charger will transfer to "Inverting Mode".



DETECT TIME 3:

This is the time limit in cycles up to which the low AC input voltage "CUT-OFF 3" is allowed.



4.7 GROUP 4 PARAMETER SET UP: INPUT HIGH LIMIT

Please refer to Parameters under Group 4 at Fig 4.1. Details of Parameter set up are given below:

TABLE 4.7. GROUP 4 PARAMETER SET UP: INPUT HIGH LIMIT									
Page No. for Group 4 (Fig 4.1)	Parameter	Setting range				Default value			
		2212	3012	2224	4024	2212	3012	2224	4024
1	RESET VOLTAGE	120.0 – 350.0V				135.0V			
2	CUT OFF VOLT 1	120.0 – 350.0V				140.0V			
3	DETECT TIME 1	0 – 2000 cycles				60 cycles			
4	CUT OFF VOLT 2	120.0 – 350.0V				145.0V			
5	DETECT TIME 2	0 – 2000 cycles				15 cycles			
6	CUT OFF VOLT 3	120.0 – 350.0V				150.0V			
7	DETECT TIME 3	0 – 2000 cycles				1 cycle			

RESET VOLTAGE:

This is the reset voltage at which the unit will revert to "Charging Mode" after it has switched over to "Inverting Mode" due to input AC voltage rising to "CUT-OFF VOLT 1/CUT-OFF VOLT 2/CUT-OFF VOLT 3".



CUT OFF VOLT 1:

If during "Charging Mode", the AC input voltage rises above "CUT-OFF VOLT 1" for period > "DETECT TIME 1", the EVO Inverter Charger will transfer to "Inverting Mode".



DETECT TIME 1:

This is the time limit in cycles up to which high AC input voltage "CUT-OFF VOLT 1" is allowed.



CUT OFF VOLT 2:

If during "Charging Mode", the AC input voltage rises above "CUT-OFF VOLT 2" for period > "DETECT TIME 2", the EVO Inverter Charger will transfer to "Inverting Mode".



DETECT TIME 2:

This is the time limit in cycles up to which high AC input voltage "CUT-OFF VOLT 2" is allowed.



CUT OFF VOLT 3:

If during "Charging Mode", the AC input voltage rises above "CUT-OFF VOLT 3" for period > "DETECT TIME 3", the EVO Inverter Charger will transfer to "Inverting Mode".



DETECT TIME 3:

This is the time limit in cycles up to which high AC input voltage "CUT-OFF VOLT 3" is allowed.



4.8 GROUP 5 PARAMETER SET UP: OTHER FUNCTIONS

Please refer to Parameters under Group 5 at Fig 4.2. Details of Parameter set up are given below:

Page No. for Group 5 (Fig 4.2)	Parameter	Setting range				Default value			
		2212	3012	2224	4024	2212	3012	2224	4024
1	POWER SAVING	1 = Enable 0 = Disable				1 = Enable			
2	ENTER POINT	4 – 50W				6W	8W	6W	8W
3	WAKE UP POINT	5 – 50W				7W	10W	7W	10W
4	REMOTE SWITCH	0 = Button Type 1 = Switch Type				Button type			
5	RELAY FUNCTION	0 = Charge/Other 1 = Normal/Fault 2 = Generator				2 = Generator			
6	COMM ID	1 – 255				1			
7	BUZZER	1 = ON 0 = OFF				1 = ON			
8	DISCHARGE BEEP	1 = ON 0 = OFF				0 = OFF			
9	DEFAULT RESET	0 = No 1 = Yes				0 = No			
10	DATALOG DISABLE DATALOG TIME	0 = Disable, 1 = 1 sec, 2 = 10 sec, 3 = 30 sec 4 = 1 min, 5 = 5 min, 6 = 10 min				1 = 1 sec			
11	PARAMETER SAVE	0 = No 1 = Yes				0 = No			

POWER SAVING:

Enable or disable Power Saving Mode when in "Inverting Mode".



ENTER POINT:

If the value of power drawn by AC load falls to the "ENTER POINT" value for 5 sec, the unit will enter "Power Save Mode".



WAKE UP POINT:

If the unit is in "Power Save Mode" and the value of the AC power of the load rises to "WAKE UP POINT", the unit will quit "Power Save Mode" and will start operating in full voltage "Inverting Mode".

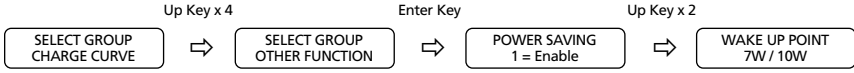

REMOTE SWITCH:

This selection is used when ON/OFF control of EVO Inverter Charger is desired through external 12 VDC signal fed to Remote ON/OFF terminals on the Front Panel of EVO Inverter Charger (15, Fig 2.1 in EVO Inverter Charger Owner's Manual) On/Off Logic Diagram is shown in Fig 4.8 below:

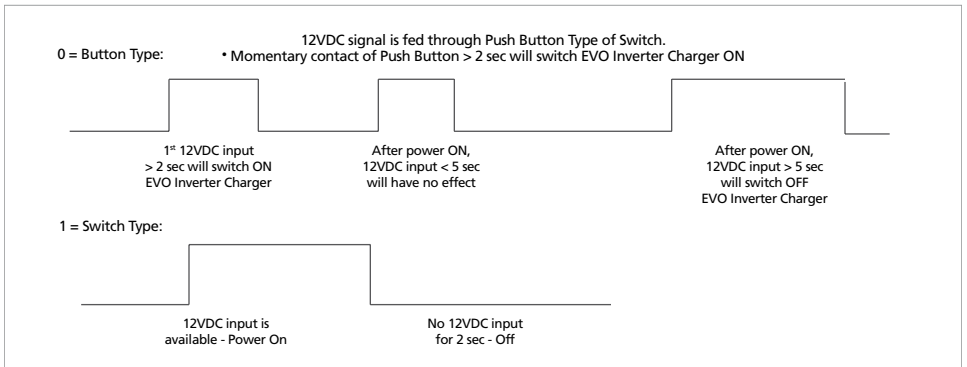

Fig 4.8. On/Off Logic Diagram for Remote Switch Options



CAUTION!

On/Off Logic shown in Fig 4.8 also controls the operation of the On/Off Button on the front panel of EVO Inverter Charger (11, Fig 2.1 in EVO Inverter Charger Owner's Manual). The Default Setting is "Button Type".

If the On/Off control is changed to external "Remote Switch", it will not be possible to switch On/Off the EVO Inverter Charger from the front panel On/Off Push Button because it will work with Switch Type Logic at Fig 4.8: it will be ON only as long as the Push Button is kept pressed and will switch off when released.



RELAY FUNCTION:

This is to select the function of Status Relay. (14, Fig 2.1 in the EVO Manual) The Status Relay has 2 sets of contacts: (i) Normally Open "NO" and "Common" and (ii) Normally Closed "NC" and "Common". "NO" and "Common" contacts will be open when the Status Relay is de-energized and will close when the relay energizes. "NC" and "Common" will be closed when the Status Relay is de-energized and will open when the reay energizes.

- 0 = Charger/Other: When the EVO Inverter Charger is in Charging Mode, the Status Relay turns OFF; in Other Mode (other than Charging Mode, the Relay is ON.
- 1 = Normal/Fault: When the EVO Inverter Charger is in Fault Mode, the Status Relay turns ON. The Relay is OFF when not in Fault Mode.
- 2 = Generator: When the battery voltage is lower than "LOW VOLT ALARM", the Status Relay turns ON. When the battery voltage is higher than the "RESET VOLTAGE", the Status Relay turns OFF. This function may be used for Generator Auto Start/Stop in conjunction with optional external Generator Auto Stop/Start Module. (See Section 4.7 of EVO Manual)



COMM ID:

Communication ID- This sets the ID number for the COMM Port and EVO-RC Remote Control.



BUZZER:

Set the buzzer ON/OFF.



DISCHARGE BEEP:

To select the buzzer ON/OFF while in "Inverting Mode".



DEFAULT RESET

This is to reset all of the parameters to the Default Values.



DATALOG TIME AND DATALOG DISABLE:

Set the time period of the data log.

0 = Disable 1 = 1 sec 2 = 10 sec 3 = 30 sec
 4 = 60 sec 5 = 5 min 6 = 10 min



PARAMETER SAVE

Save all parameters to SD Card. (see Details at Section 5)



4.9 GROUP 6 PARAMETER SETUP: TIME SETTING

Please refer to Parameter "TIME SETTING" under Group 6 at Fig 4.2. Set up details are given below. The Date and Time Format is Year/Month/Day Hour:Minute (24 hour clock):



4.10 GROUP 7 PARAMETER SETUP: STOP SD CARD

Please refer to Parameter "STOP SD CARD" under Group 7 at Fig 4.2. Set up details are given below:

Once SD Card is being used, it should be removed/ejected only after the operation of the Card has been stopped as shown below and message "Please remove SD Card" appears. If the SD card is not removed within 30 sec, it will reset. After the card is removed, it reverts to the original operating screen.

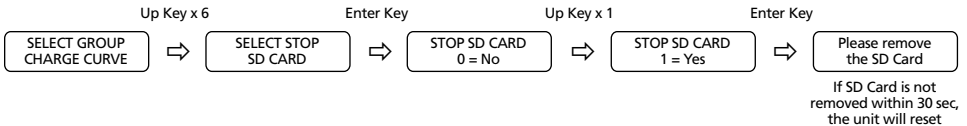

5.1 SD CARD GENERAL INFORMATION

SD Card slot has been provided for data logging and for saving the programmed parameters. SD card supports FAT16/FAT32 format up to 16GB in size.

When the SD card is inserted, the LCD screen will display the following.

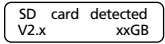

SD card is detected and shows the Version and capacity. "xx" is the capacity.

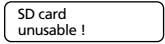

Not supported card.



CAUTION!

Do not remove SD Card when data logging has been enabled (may corrupt files). Follow "STOP SD CARD" procedure (Section 4.10) before removing the SD Card.

5.2 DATA LOGGING

It is highly recommended that the current date and time be set as the data log files will be recorded with this EVO's programmed date and time. Please see Section 4.9 for "TIME SETTING".

Data logging can be disabled and data logging times can be selected using Parameter Setting Mode under "Other Functions" (See Section 4.8 and Table 4.8 under heading "DATALOG TIME" and "DATALOG DISABLE").

When the SD card is inserted and Data Logging Function is enabled (Default), the EVO Inverter Charger will start recording statistics and events on the card.



Data log function has been initiated and new file is being created. Do not remove the SD card when file creating is displayed.

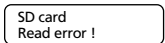

Read error, the data log function/update/upload will stop.

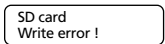

Write error. The Data logging function will stop.

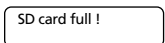

1. Card full. Data logging function has stopped.
2. There is not enough space to create Data Log File Folder or to save file with saved programmed parameters.
NOTE: Once there is enough space to create a Data Log File Folder and subsequently, it runs out of capacity due to recording newer data, it will start to overwrite on older files.

5.3 DATA LOG FILES AND VIEWING DATA LOG FILES USING MICROSOFT EXCEL

The Data Log Files are written as Text Files (.txt) in the DATALOG Folder on the SD Card's Root Directory. Table 5.1 is an image of the DATALOG Folder showing example of the Data Log Files. The File Name Format is month/day/hour/minute.txt (MMDDhmm.txt).

TABLE 5.1 Example of Data Log Folder

10141103.TXT	2014/10/14 AM 11:03	Text Document	128 KB
10141228.TXT	2014/10/14 PM 12:28	Text Document	128 KB
10141353.TXT	2014/10/14 PM 01:53	Text Document	128 KB
10141518.TXT	2014/10/14 PM 03:18	Text Document	128 KB
10141643.TXT	2014/10/14 PM 04:43	Text Document	128 KB
10141808.TXT	2014/10/14 PM 06:08	Text Document	128 KB
10141933.TXT	2014/10/14 PM 07:33	Text Document	128 KB
10142058.TXT	2014/10/14 PM 08:58	Text Document	128 KB
10142223.TXT	2014/10/14 PM 10:23	Text Document	128 KB
10142348.TXT	2014/10/14 PM 11:48	Text Document	128 KB
10150113.TXT	2014/10/15 AM 01:13	Text Document	128 KB
10150238.TXT	2014/10/15 AM 02:38	Text Document	128 KB
10150403.TXT	2014/10/15 AM 04:03	Text Document	128 KB
10150528.TXT	2014/10/15 AM 05:28	Text Document	128 KB
10150653.TXT	2014/10/15 AM 06:53	Text Document	128 KB
10150818.TXT	2014/10/15 AM 08:18	Text Document	128 KB

Table 5.2 shows an example of one of the File's contents opened with a general purpose Text Reader. The First Row is Inverter Model, the Second Row is the title of columns, separate by ','.

TABLE 5.2 Contents of Data Log File

```

990-3254
Date:Tue:0m status:0m freq:0m vlt:0Vrid status:0Vrid freq:0Vrid vlt:0Vlapt current:0Apt W:0Vlapt watt:0Wapt freq:0Wapt vlt:0Wapt current:0Apt W:0Wapt watt:0W Battery %
2014/10/14 12:29:52:33340:0000:00:0000:62:33341:0000:00:0000:42:+00.10:+0012:+0012:0000.00:0000.43:+00.10:+0012:+0012:25.0002:0000.0:00000.0:00025.0:00026.0:00026.7:00027.1:0:0:000000:0:
2014/10/14 12:29:53:33340:0000:00:0000:62:33341:0000:00:0000:42:+00.10:+0012:+0012:0000.00:0000.43:+00.10:+0012:+0012:25.0002:0000.0:00000.0:00025.0:00026.0:00026.7:00027.1:0:0:000000:0:
2014/10/14 12:29:54:33340:0000:00:0000:62:33341:0000:00:0000:42:+00.10:+0012:+0012:0000.00:0000.43:+00.10:+0012:+0012:25.0002:0000.0:00000.0:00025.0:00026.0:00026.7:00027.1:0:0:000000:0:
2014/10/14 12:29:55:33340:0000:00:0000:62:33341:0000:00:0000:42:+00.10:+0012:+0012:0000.00:0000.43:+00.10:+0012:+0012:25.0002:0000.0:00000.0:00025.0:00026.0:00026.7:00027.1:0:0:000000:0:
2014/10/14 12:29:56:33340:0000:00:0000:62:33341:0000:00:0000:42:+00.10:+0012:+0012:0000.00:0000.43:+00.10:+0012:+0012:25.0002:0000.0:00000.0:00025.0:00026.0:00026.7:00027.1:0:0:000000:0:
2014/10/14 12:29:57:33340:0000:00:0000:62:33341:0000:00:0000:42:+00.10:+0012:+0012:0000.00:0000.43:+00.10:+0012:+0012:25.0002:0000.0:00000.0:00025.0:00026.0:00026.7:00027.1:0:0:000000:0:
2014/10/14 12:29:58:33340:0000:00:0000:62:33341:0000:00:0000:42:+00.10:+0012:+0012:0000.00:0000.43:+00.10:+0012:+0012:25.0002:0000.0:00000.0:00025.0:00026.0:00026.7:00027.1:0:0:000000:0:
2014/10/14 12:29:59:33340:0000:00:0000:62:33341:0000:00:0000:42:+00.10:+0012:+0012:0000.00:0000.43:+00.10:+0012:+0012:25.0002:0000.0:00000.0:00025.0:00026.0:00026.7:00027.1:0:0:000000:0:
2014/10/14 12:30:00:33340:0000:00:0000:62:33341:0000:00:0000:42:+00.10:+0012:+0012:0000.00:0000.43:+00.10:+0012:+0012:25.0002:0000.0:00000.0:00025.0:00026.0:00026.7:00027.1:0:0:000000:0:
    
```

Follow procedure given below to open Data Log Files in Excel:

- Start Excel.
- Click File Menu Button / Microsoft Office Button on the left hand corner.
- Click "Open" from the Drop Down Menu.
- Navigate to the Directory where the Log Files downloaded from the SD Card are located.
- Click on "File Types" selection button at the bottom right corner (shows "All Excel Files" as default) and select Text files from the Drop Down Menu.
- All Text Files (.txt) will be displayed. The screen will look like Fig 5.1.



Fig 5.1 Screen Showing .txt Files

- Click "Open" Button (Bottom right corner of Fig 5.1).
- Text Import Wizard – Step 1 will be shown (Fig 5.2). Choose "Delimited" File Type".

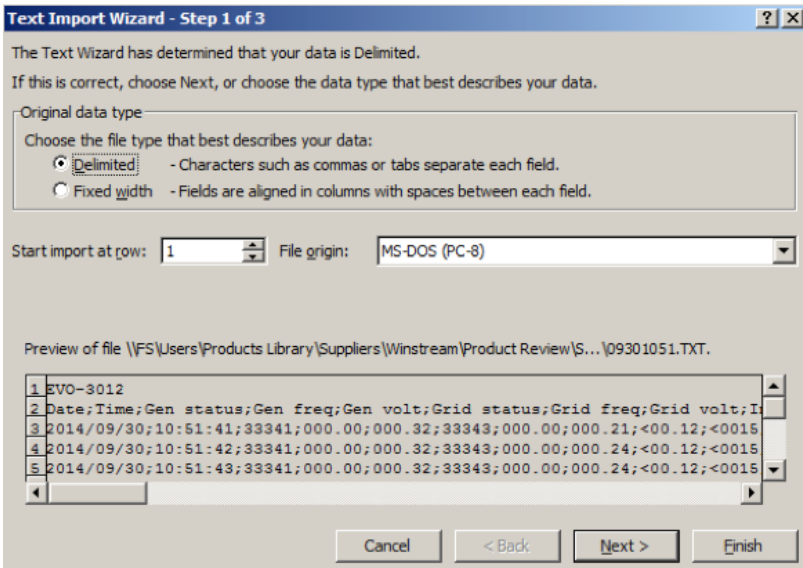

Fig 5.2 Screen Shot of Step 1 of "Text Import Wizard" in Excel

- Text Import Wizard – Step 2 will appear (see Fig 5.3). Choose "Semicolon" and click 'Finish' button.

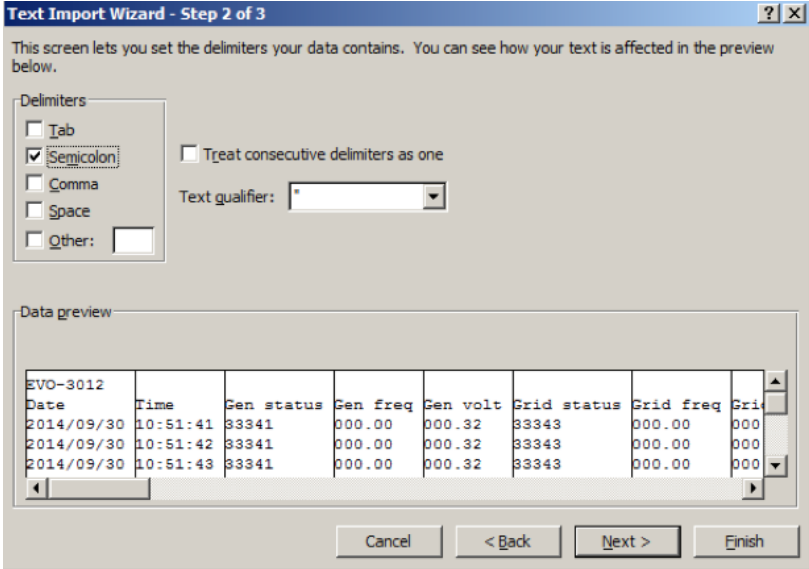

Fig 5.3 Screen Shot of Step 2 of "Text Import Wizard" in Excel

- Data as in Fig 5.4 will be displayed on your Worksheet, with the Log Data stored in Columns and Rows.

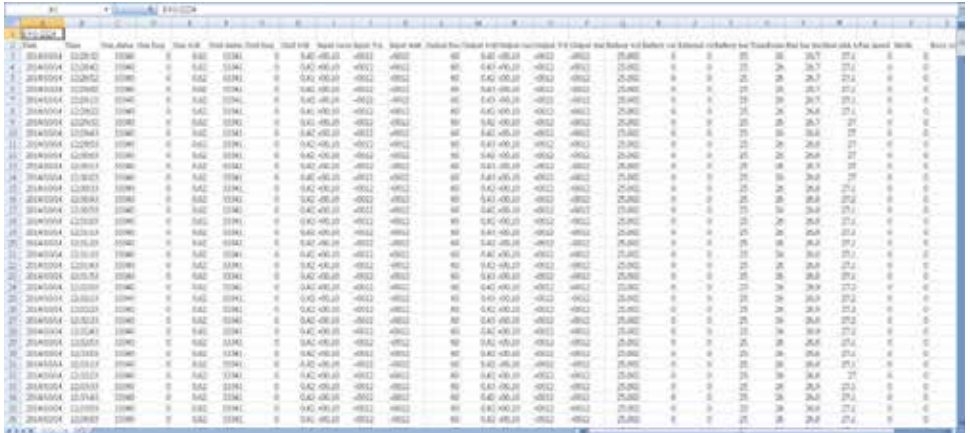

Fig 5.4 Screen Shot and Data Log Work Sheet

5.4 SAVING / UPLOADING PROGRAMMED PARAMETERS

5.4.1 Saving Programmed Parameters

All the programmed parameters can be saved on an SD Card (FAT 16 / FAT 32 Format, up to 16 GB capacity). The parameters will be saved in File named “xxxx_yyy.cfg”, where the first group of 4 digits xxxx is the Model No. e.g. 2212 or 2224 or 3012 or 4024 and the second group of 3 digits YYY is the Revision No. for that Model e.g. 061.

- For saving, first insert the SD Card in the SD Card Slot.
- Then, go to “Parameter Save” Screen (See Section 4.8 and Table 4.8 – under heading “PARAMETER SAVE”). Steps are given below:



- Now, select **PARAMETER SAVE 1 = Yes**. The parameters will be saved and message **Saved file end** will be seen and then, the screen will revert to **PARAMETER SAVE 0 = No**.

5.4.2 Uploading Saved Parameters

If there is a “xxxx_yyy.cfg” file in the SD card with stored programmed parameters, then on inserting the card, the Remote Control will ask to upload the Config File. Press Enter Button to confirm or Back Button to cancel.

Upload conf? Yes = Enter Key Asks to confirm upload.

Upload conf? No = Back Key Asks to cancel upload.

Upload conf 1 % Configuration uploading.

SECTION 6 | Monitoring of Operation Using LED and Buzzer

TABLE 6.1 LED & BUZZER INDICATIONS FOR OPERATION MONITORING

Status	Green LED "Status"	Red LED "Alarm" (Fault)	Buzzer
Power ON	Flash 3 times	OFF	OFF
Power OFF	ON	ON	OFF
Normal charging	Flash 1 time per second	OFF	OFF
Equalization charging	Flash 2 times per second	OFF	OFF
Inverting	ON	OFF	Beep per 3 second (Default OFF)
Low battery alarm	ON	Flash 1 time per second	Beep per second
Power saving	Flash 1 time per 3 second	OFF	OFF
Standby	OFF	OFF	OFF
Fault	OFF	ON	ON

NOTE:

Buzzer is available only in EVO Inverter Charger. There is no buzzer in Remote Control EVO-RC.

TABLE 7.1 FAULT MESSAGES AND TROUBLESHOOTING GUIDE

**NOTES: 1. Please see Table 6.1 for LED indications in EVO-RC and buzzer indications in EVO Inverter Charger
2. Buzzer is available only in EVO Inverter Charger. There is no buzzer in Remote Control EVO-RC**

Fault Message	Symptoms and Trouble Shooting
<p>Battery low voltage!</p>	<ul style="list-style-type: none"> • EVO Inverter Charger is in FAULT MODE because the battery voltage has dropped to the set lower threshold of "BATT LOW VOLTAGE" • When the battery voltage drops to the set lower threshold of "BATT LOW VOLTAGE", activation of this fault protection is initiated. The Red LED marked "Alarm" will flash once per second and the buzzer in EVO Inverter Charger will beep once per second. The Inverter Section will continue to operate normally and the Green LED marked "Status" will continue to be ON steady (NOTE: "Battery low voltage!" will not be displayed during this time) • If the battery voltage stays at or below the above threshold for duration equal to the set "LV DETECT TIME", only the Inverter Section will be switched OFF and message "Battery low voltage!" will be displayed. The Red LED marked "Alarm" will now change to steady ON, the Green LED marked "Status" will switch OFF and the buzzer in EVO Inverter Charger will now beep steady. If the "Battery low voltage!" fault condition is not reset within the "LV CUT OFF TIME", EVO Inverter Charger will be shut down completely after the expiry of "LV CUT OFF TIME". • If the batteries are charged by external charger connected directly to the batteries or through the External Charger Input (3, 4 in Fig 2.1 in EVO Inverter Charger Manual) and the battery voltage recovers to the set "RESET VOLTAGE" before the expiry of "LV CUT OFF TIME" while in "Battery low voltage!" fault condition, the Inverter Section will restart and "Battery low voltage!" fault condition will be cleared. • While in "Battery low voltage!" fault condition, if AC input is made available before the expiry of "LV CUT OFF TIME", the "Battery low voltage!" fault condition will be cleared. The EVO Inverter Charger will restart in Inverter Mode, synchronize with the AC input and then, transfer to the AC input at zero crossing. It will now operate in Charging Mode
<p>Battery ultra low voltage!</p>	<ul style="list-style-type: none"> • EVO Inverter Charger is in FAULT MODE because the battery voltage has dropped to 9V for EVO-2212 / 3012 or to 18 V for EVO-2224 / 4024 • When the battery voltage drops to 9V for the 12V version of EVO Inverter Charger or 18V for the 24V version, only the Inverter Section will be switched OFF and message "Battery ultra low voltage!" will be displayed. Red LED marked "Alarm" will be steady ON, the Green LED marked "Status" will be switched OFF and the buzzer in EVO Inverter Charger will beep steady. • When the duration in "Battery ultra low voltage!" fault condition is equal to the set duration of "LV DETECT TIME", the message will change to "Battery low voltage!" if "Battery low voltage!" fault condition is not reset within the "LV CUT OFF TIME", EVO Inverter Charger will be shut down completely after the expiry of "LV CUT OFF TIME". • If the batteries are charged by external charger connected directly to the batteries or through the External Charger Input (3, 4 in Fig 2.1 in EVO Inverter Charger Manual) and the battery voltage recovers to the set "RESET VOLTAGE" before the expiry of "LV CUT OFF TIME" while in "Battery low voltage!" fault condition, the Inverter Section will restart and "Battery low voltage!" fault condition will be cleared. • While in "Battery low voltage!" fault condition, if AC input is made available before the expiry of "LV CUT OFF TIME", the "Battery low voltage!" fault condition will be cleared. The EVO Inverter Charger will restart in Inverter Mode, synchronize with the AC input and then, transfer to the AC input at zero crossing. It will now operate in Charging Mode

<p>Battery over voltage!</p>	<p>EVO Inverter Charger is in FAULT MODE because the battery voltage has risen to the set upper threshold of "BATT OVER VOLTAGE"</p> <p>(a) AC input is not available and EVO Inverter Charger is operating in Inverting Mode:</p> <ul style="list-style-type: none"> • There will be no AC output because the Inverter Section will be switched OFF. The Green LED marked "Status" will be switched OFF and the Red LED marked "Alarm" will be steady ON. The buzzer in EVO Inverter Charger will beep steady • The fault will be cleared automatically when the battery voltage drops to 0.5V below the set upper threshold of "BATT OVER VOLT" <p>(b) AC input is available and EVO Inverter Charger is operating in Charging Mode:</p> <ul style="list-style-type: none"> • There will be no AC output or charging because the Transfer Relay will be de-energized and PWM drive to the Inverter Section will be switched OFF. • The fault will be cleared automatically when the battery voltage drops to 0.5V below to the set upper threshold of "BATT OVER VOLT". The EVO Inverter Charger will restart in Inverting Mode, synchronize with the AC input and then, the Transfer Relay will be energized to transfer to AC input at zero crossing. The unit will, thus, resume operation in "Charging Mode"
<p>Input over current!</p>	<p>EVO Inverter Charger is in FAULT MODE because the input current being drawn from the AC input source (Input current = Charging Current + Pass Through Current to the load) is 1A more than the set threshold of " MAXIMUM CURRENT" for 5 seconds</p> <ul style="list-style-type: none"> • There will be no AC output because the Transfer Relay will be de-energized, charging will be stopped and PWM drive to the Inverter Section will be switched OFF. The Green LED marked "Status" will be switched OFF and the Red LED marked "Alarm" will be steady ON. The buzzer in EVO Inverter Charger will beep steady • EVO Inverter Charger will be latched in OFF condition and will require manual reset by powering OFF, waiting for 1 minute and then powering ON again • The set threshold of "MAXIMUM CURRENT" (Section 4.5) should match the breaker capacity of the AC input source / AC input Branch Circuit. If AC input current capacity cannot be increased, reduce the AC load / "BULK CURRENT" (Section 4.4) accordingly.
<p>Output over current!</p>	<p>EVO Inverter Charger is in FAULT MODE because the instantaneous output current being drawn by the AC load in Inverting Mode is 330% of the rated value of the EVO Inverter Charger (sampling time is 33 micro seconds)</p> <ul style="list-style-type: none"> • There will be no AC output because the Inverter Section will be switched OFF. The Green LED marked "Status" will be switched OFF and the Red LED marked "Alarm" will be steady ON. The buzzer in EVO Inverter Charger will beep steady • EVO Inverter Charger will be latched in OFF condition and will require manual reset by powering OFF, waiting for 1 minute and then powering ON again • Ensure that the maximum instantaneous surge current of the load is not more than 300% of the rated current of the EVO Inverter Charger for 1 millisecond
<p>Output over load! Output over load 1! Output over load 2! Output over load 3! Output over load 4!</p>	<p>EVO Inverter Charger is in FAULT MODE because of overload conditions in Inverting Mode:</p> <ul style="list-style-type: none"> • There will be no AC output because the Inverter Section will be switched OFF. The Green LED marked "Status" will be switched OFF and the Red LED marked "Alarm" will be steady ON. The buzzer in EVO Inverter Charger will beep steady • EVO Inverter Charger will be latched in OFF condition and will require manual reset by powering OFF, waiting for 1 minute and then powering ON again • Ensure that overloading is limited to the specified limit <p>Output voltage is less than 96Vrms for 300 cycles (5 seconds at 60Hz)</p> <p>Output power is over 110% for 30 min</p> <p>Output power is over 120% for 5 minutes</p> <p>Output power is over 140% for 30 seconds</p> <p>Output power is over 150% for 5 seconds</p>

<p>Output short circuit!</p>	<p>EVO Inverter Charger is in FAULT MODE because there is a short circuit on the output side in Inverter Mode. Short circuit protection is activated when the output current is over 18.33Arms and output voltage is less than 15 Vrms for 6 cycles (0.1 second for 60 Hz)</p> <ul style="list-style-type: none"> There is no AC output because the Inverter Section has been switched OFF. The Green LED marked "Status" will be switched OFF and the Red LED marked "Alarm" will be steady ON. The buzzer in EVO Inverter Charger will beep steady EVO Inverter Charger will be latched in OFF condition and will require manual reset by powering OFF, waiting for 1 minute and then powering ON again <p>NOTE: If there is short circuit condition in Charging Mode i.e. when AC input is available, short circuit condition on the output side will trip the AC input breaker. The load will be transferred to the Inverter Section and the Inverter Section will then see short circuit condition and will shut down as described above</p>
<p>Output failure!</p>	<p>EVO Inverter Charger is in FAULT MODE because AC input from Grid / Generator has been connected to the AC Output terminals by mistake. 10VAC or above seen at the AC Output Terminals at the time of boot up of EVO Inverter Charger will activate this protection</p> <ul style="list-style-type: none"> The Green LED marked "Status" will be switched OFF and the Red LED marked "Alarm" will be steady ON. The buzzer in EVO Inverter Charger will beep steady EVO Inverter Charger will be latched in OFF condition and will require manual reset by powering OFF, waiting for 1 minute and then powering ON again <p>Check the connection. If there is 10V over at the output terminal, remove the connection.</p>
<p>Transformer over heat!</p>	<p>EVO Inverter Charger is in FAULT MODE because the main Bidirectional Transformer in the EVO Inverter Charger has overheated to 150°C</p> <ul style="list-style-type: none"> The Green LED marked "Status" will be switched OFF and the Red LED marked "Alarm" will be steady ON. The buzzer in EVO Inverter Charger will beep steady If in Inverting Mode, Inverter Section will be switched OFF. If in Charging Mode, the Transfer Relay will be de-energized and the Inverter Section will be switched OFF. Check that the fans are working properly, there is no blockage of air suction and discharge vents, adequate cool replacement air is available and the ambient temperature is within the limits. Reduce the load / "BULK CURRENT" (Section 4.4) The fault will be cleared when the transformer has cooled down to 80°C
<p>Heat sink over heat!</p>	<p>EVO Inverter Charger is in FAULT MODE because the internal heat sink in the EVO Inverter Charger has overheated to 60°C</p> <ul style="list-style-type: none"> The Green LED marked "Status" will be switched OFF and the Red LED marked "Alarm" will be steady ON. The buzzer in EVO Inverter Charger will beep steady If in Inverting Mode, Inverter Section will be switched OFF. If in Charging Mode, the Transfer Relay will be de-energized and the Inverter Section will be switched OFF. Check that the fans are working properly, there is no blockage of air suction and discharge vents, adequate cool replacement air is available and the ambient temperature is within the limits. Reduce the load and "BULK CURRENT" (Section 4.4) The fault will be cleared when the heat sink has cooled down to 40°C
<p>SD card unusable!</p>	<ul style="list-style-type: none"> Data logging will not start. Check that the format is FAT16/FAT32. Check that the capacity is less than 16 GB. Re-format the card.
<p>SD card read error!</p>	<ul style="list-style-type: none"> Data logging stops. Remove and re-insert the card.
<p>SD card write error!</p>	<ul style="list-style-type: none"> Data logging stops. Remove and re-insert the card.
<p>SD card full!</p>	<ul style="list-style-type: none"> Data logging stops. Move or delete files or re-format the card.

	MODEL NO.	EVO-RC
COMPATIBLE INVERTER CHARGERS	MODEL NUMBERS	EVO-2212, EVO-3012, EVO-2224, EVO-4024
DISPLAY	LCD DISPLAY	2 Rows, 16 Character each, Alpha-Numeric LCD Display
	LED INDICATORS	Green (Status); Red (Fault / Alarm)
INPUT / OUTPUT CONNECTION	CABLE SET	RJ-45 Data Cable (Straight Wired); 10 Meters / 33 ft
ENVIRONMENT	OPERATING TEMPERATURE RANGE	-20°C to 60°C
DIMENSIONS	(W X H X D), MM	144 x 114 x 35.5
	(W X H X D), INCHES	5.6 x 4.5 x 1.4
WEIGHT	WEIGHT WITHOUT CABLE	0.2 kg / 0.4 lb
	WEIGHT WITH CABLES	0.5 kg / 1.2 lb

2 YEAR LIMITED WARRANTY

EVO-RC manufactured by Samlex America, Inc. (the “Warrantor”) is warranted to be free from defects in workmanship and materials under normal use and service. The warranty period is 2 years for the United States and Canada, and is in effect from the date of purchase by the user (the “Purchaser”).

Warranty outside of the United States and Canada is limited to 6 months. For a warranty claim, the Purchaser should contact the place of purchase to obtain a Return Authorization Number.

The defective part or unit should be returned at the Purchaser’s expense to the authorized location. A written statement describing the nature of the defect, the date of purchase, the place of purchase, and the Purchaser’s name, address and telephone number should also be included.

If upon the Warrantor’s examination, the defect proves to be the result of defective material or workmanship, the equipment will be repaired or replaced at the Warrantor’s option without charge, and returned to the Purchaser at the Warrantor’s expense. (Contiguous US and Canada only) using a carrier of the warrantor’s choice.

Warranty service shall be performed only by the Warrantor. Any attempt to remedy the defect by anyone other than the Warrantor shall render this warranty void. The warranty does not apply to units with a serial number that has been altered, removed or modified in any way.

There is no warranty for defects or damages to equipment or parts caused by:

- Installation, alternation, inspection or removal
- Normal wear and tear
- Abuse or misuse of the equipment including exposure to excessive heat, salt or fresh water spray, or water immersion
- Corrosion, fire, lightening, biological infestations or Acts of God
- Repairs attempted by anyone other than the Warrantor
- Improper use, contrary to operational instructions provided in product manual
- Shipping or transport

No other express warranty is hereby given and there are no warranties which extend beyond those described herein. This warranty is expressly in lieu of any other expressed or implied warranties, including any implied warranty of merchantability, fitness for the ordinary purposes for which such goods are used, or fitness for a particular purpose, or any other obligations on the part of the Warrantor or its employees and representatives.

There shall be no responsibility or liability whatsoever on the part of the Warrantor or its employees and representatives for injury to any persons, or damage to person or persons, or damage to property, or loss of income or profit, or any other consequential or resulting damage which may be claimed to have been incurred through the use or sale of the equipment, including any possible failure of malfunction of the equipment, or part thereof. The Warrantor assumes no liability for incidental or consequential damages of any kind.

Samlex America Inc. (the “Warrantor”)
www.samlexamerica.com

Notes

Contact Information

Toll Free Numbers

Ph: 800 561 5885

Fax: 888 814 5210

Local Numbers

Ph: 604 525 3836

Fax: 604 525 5221

Website

www.samlexamerica.com

USA Shipping Warehouse

Kent WA

Canadian Shipping Warehouse

Delta BC

Email purchase orders to
orders@samlexamerica.com



samlexamerica®